



QUALITY • INNOVATION • CERTIFIED

SURGICAL **INSTRUMENTS** CATALOGUE

Manufacturers & Exporters of Quality
Surgical, Dental, Orthopaedic & Beauty Instruments

www.surgiforge.com

I N D E X

Orthopaedics.....	01-14
Needle Holders with Tungsten Carbide Inserts.....	15-18
Dissecting Forceps and Needle holders with Tungsten Carbide Inserts.....	19
Scissors & Dissecting Forceps with Tungsten Carbide inserts.....	20
Scissors with Tungsten Carbide Inserts.....	21-26
Combined Suction and Irrigation Cannulae.....	27
Suction Instruments.....	28-31
Vaccum Curettes for Aspiratin Lipectomy, Suction Instruments.....	32
STILLE Plaster Shears.....	33
Plaster Shears.....	34-36
Finger Nail Instruments.....	37
Wire Cutting Pliers.....	38
Wire Holding forceps,Flat-nosed Pliers, Pliers for bending and cutting wires.....	39-40
JORDAN instruments for subcutaneous Tibia Cerclage.....	41
Cerclage Instruments.....	42
Drilling Chucks.....	43
STEINMANN Pins.....	44
Traction Bows,Distractor.....	45
Wire Extension.....	46-47
Meniscus Knives.....	48-49
Meniscus-and Cartilage Forceps.....	50
Bone Cutting Forceps.....	51
Bone Rongeurs.....	52
Bone Clamps.....	53
Osteotomes ,Chisels and Gouges with HARTPRESS -handle.....	54-55
Osteotomes.....	56
Osteotomes Chisels and Gouges.....	57-58
Tampers - osteotomes, Chisels and Gouges.....	59
Mallets.....	60-62
Bone Curettes.....	63-68
Bone File and Rasps.....	68-71
Raspatories with HARTPRESS-handle.....	72
Raspatories.....	73-79
Special Bone Levers.....	80
Bone Levers.....	81-85

Elevators and Bone Levers.....	86
Wire Saws and Conductor.....	87
Amputation Saws.....	88-89
Amputation Retractors.....	90
Amputations and Resection Knives.....	91
Amputation.....	92
Rongeurs.....	93-99
Punches.....	100-102
Rib Spreaders-and Contractors.....	103-105
Thoracic Retractors.....	106
Sternotomy-Spreaders	106-108
Rib Spreaders.....	109-112
Rib Raspatories.....	113-114
Rib Holding Forceps, Bone Cutting Forceps.....	115
Multi-Purpose Clamps.....	116-122
Aorta-Anastomosis Clamps.....	123-129
Vena-Cave Clamps.....	130-141
Anastomosis Clamps.....	142
Non-traumatic Haemostatic Forceps.....	143-144
Anastomosis-and Multi-Purpose-Clamps- Pediatric types.....	145-146
Ring Handle Bulldog Clamps.....	147
Ultra-Light-Forceps.....	148-149
Biopotome and Aortic Dilators.....	150-151
Irrigating Cannulae,Embolus Grasping Forceps,Dilators.....	152-154
Tound-and Tracheal Hooks and Dilators.....	155-156
Tracheal Tubes with inner tubes.....	157
Obstetrics-Placenta and Ovum Forceps.....	158-159
Obstetrics Forceps.....	160-162
Scissors of Obstetrics, Umbilical cord clamp.....	163
Obstetrics-Pelvimeters.....	164-165
Gynaecological Instruments.....	166
Placenta-and Ovum Curettes.....	167
Uterine Curettes.....	168
Uterine Scoops.....	169
Biopsy Forceps.....	170-172
Biopsy Curettes.....	173
Myoma Instruments.....	174
Uterine Elevating Forceps.....	175-177
Polypus and Ovum Forceps.....	178

Uterine Tenaculum Forceps.....	179-183
Uterine Dressing Forceps.....	184-185
Uterine Probes.....	186
Endospecula For Cervix.....	187
Uterine Dilators - Complete Sets.....	188
Uterine Dilators.....	189
Vaginal Retractors	190
Vaginal Speculas.....	191
Vaginal & Wound Retractor / Vaginal Specula.....	192
Vaginal Specula / Retractors.....	193
Vaginal Specula-for children and virgins.....	194
Vaginal Specula-for children &virgins / Vario Retractor.....	195
Vaginal Specula.....	196
Vaginal Specula-upper and lower blades.....	197
Vaginal Specula-Sets, upper and lower blades.....	198-199
Vaginal Specula.....	200-201
Trocars.....	202
Genito-Urinary Instruments & Circumcision Clamps.....	203
Genito-Urinary Instruments.....	204
Genito-Urinary Instruments-Prostatectomy.....	205
Bladder Retractors.....	206
Kidney Stone Forceps.....	207
Kidney Elevating Forceps.....	208
Kidney Clamps.....	209-210
Gall Stone Forceps.....	211
Gall Duct Dilators & Gall Stone Scoops.....	212
Gall Ducts Probes.....	213
Gall Bladder Forceps and Gall Duct Scissors.....	214
Gall Duct Forceps and Choledochus Forceps.....	215
Gall Duct Forceps.....	216
Haemorrhoidal Forceps.....	217-218
Biopsy Forceps & Swab Holders.....	219
Biopsy forceps for rectum.....	220
Anusopes-Sphincteroscopes.....	221
Rectal Specula.....	222-223
Sigmold Anastomosis Forceps.....	224-225
Anastomosis Forceps.....	226
Intestinal and Pylorus Clamps.....	227
Stomach Clamps.....	228
Gastro-Intestinal Forceps, twin.....	229
Intestinal Clamps.....	230-231

Intestinal Clamps, Soft elastic.....	232-236
Intestinal Clamps for Children.....	237
Ultra -Light - Forceps, Dissecting Forceps.....	238
Organ - Tissue Grasping, Dissecting & Intestinal Forceps.....	239-240
Intestinal Grasping Forceps.....	241
Intestinal and Tissue Grasping Forceps.....	242
Abdominal Retractors.....	243-247
Abdominal Blades.....	248
Lamina Spreaders.....	249
Retractors for Cervical Vertebral Column.....	250
Retractors for Cervical Spine.....	251
Self Retaining Retractors for Laminectomy and other Operations.....	252
Special Retractors.....	253
Self-Retaining Laminectomy Retractors.....	254-255
Self-Retaining Retractors.....	256-259
Abdominal-and Intestinal Spatulas.....	260-261
Pelvis Retractors.....	262
Abdominal Retractors.....	263
Retractors, Abdominal Retractors.....	264
Retractors For Deep Surgery (Abdominal Retractors).....	265-266
Retractors,Lung Spatulas.....	267-272
Vario Retractor System, Germ. Fed Patent, Germ. Fed. Regd.Des.....	273
Retractors For Deep Surgery.....	274-275
Retractors.....	276-281
Retractors, Deep form.....	282
Bone Retractors and Retractors.....	284
Retractors.....	285-289
Retractors With Treanglr Handle.....	290
Wound - Trachea Retractors.....	291
Fine Wound Retractors (Dura- and Skin Retractors).....	292
Nerve - and Vessel Hooks.....	293-294
Clip Appying Forceps - Suture Set.....	295-297
Probes - Spatulas - Cotton Applicators.....	298
Guiding Probes.....	299
Ligature Needles.....	300
Suture Instruments - Ligature Needles.....	301-302
Suture Instruments - Reverdin Needles.....	303
Needle Holders.....	304-307

Micro Needle Holders With Round Handles.....	308
Needle Holders For Micro Surgery.....	309
Hysterectomy Forceps and Vaginal Clamps and Compression Forceps.....	310-311
Hysterectomy Forceps and Vaginal Clamps.....	312
Hysterectomy Forceps.....	313
Peritoneum Forceps.....	314
Dissecting- and Ligature Forceps.....	315-318
Haemostatic Forceps, Special Pattern, Tonsil Forceps.....	319
Haemostatic Forceps.....	320-323
Delicate Haemostatic Forceps.....	324-326
Muller Vessel Clips and Bulldog Clamps.....	327
Towel Clamps.....	328-329
Organ -and Tissue Grasping Forceps.....	330
Artery Traction - and Tissue Grasping Forceps.....	331
Tendon Seizing Forceps.....	332
Dressing, Sponge holding, Organ and Tissue Grasping Forceps.....	333-334
Sponge and Dressing Forceps.....	335-337
Splinter and Cila Forceps.....	338
Tissue Forceps, Lungs Dissecting Forceps.....	339
Tissue Forceps.....	340-341
Forceps, Bayonet - Shaped.....	342
Forceps.....	343
Ultra-Light Forceps.....	344
Dissecting Forceps.....	345-346
Delicate Dissecting Forceps.....	347
Delicate Dissecting, Microscopic, Sterilizing Forceps.....	348
Bandage, Cloth and Plaster Scissors.....	349
Bandage and Cloth Scissors.....	350
Wire and Plate Scissors.....	351-352
Ligature Scissors.....	353
Bowel Scissors, Cartilage Scissors.....	354
Operating and Gynaecology Scissors.....	355-357
Bone Shears.....	359
Cardiovascular and Neuro-Surgery Scissors.....	360
Vessel Scissors.....	361
Dissecting Scissors.....	362-364
Dissecting & Surgical Scissors.....	365
Dissecting Scissors.....	366-367
Surgical Scissors.....	368-370

Delicate Scissors.....	371-374
Micro Scissors, "Spring Type" Bayonet Shape.....	375-377
Scalpel Handles.....	378-379
Razor Blade Holders & Breakers.....	380
Scalpels,Dura Knives & Comedone Extractors.....	381
Cone Knives,Myomatome,Trigeminal & Tonsil Knives.....	382
Amputating Knives, Cartilage Knives, Autopsy Knives.....	383
Scalpels, Tenotomes.....	384
Scalpels,Tenotomes &Resection Knives.....	385
Autopsy & Cartilage Knives.....	386
Dissecting Knives.....	387
Examination & Measuring Instruments.....	388
Diagnostic Sets.....	389-391
Blood Lancets & Laryngeal Mirrors.....	392
Tongue Depressors.....	393-394
Stethoscopes.....	395
Percussion Hammers & Aesthesiometers.....	396
Instruments For Trumatology.....	397-400
Carbide Insterted Wired-Pin Cutting Pliers.....	401-404
Carbide Insterted Surgical Scissors.....	405
Carbide Insterted Wire Twisters.....	406
Rod Benders.....	407
Copressors-Distractors.....	408
Calcaneal-Lombardi Spreaders.....	409
Lamina Spreaders- Retractors.....	410
Rib Shears.....	411-412
Bone Rongeur -Nibbiars.....	413-417
Bone Cutting Forceps.....	418-420
Reposition -Cartilage Forceps.....	421
Bone Holding Forceps.....	422-425
Pelvic Reduction Forceps.....	426-427
Miscellaneous Instruments.....	428
Tendon Instruments.....	429
Meniscus-Tendon-Cartilage Instruments.....	430
Orthopedic Mallers-SS-Fiber.....	431-432
Elevators Spinal-SS and Fiber.....	433
Periosteal Elevators.....	434-436
Bone Curettes.....	437-439
Chisels-Osteotomes-Gouges.....	440-442
Bone Levers-Retractors.....	443-446
Bone Rasps-Files.....	447-448

Bone Tampers-Impactors-Packers.....	449
Ring Cutters-Lead Hands -Biopsy Tools.....	450
Wire Instruments -Extension Bows ETC.....	451
Pliers-Benders-Rod Instruments.....	452
Nose Pliers-Wire cutters.....	453
Nose Pliers.Pulling Forceps.Wire Cutters.....	454
Vise Grips.Nose Pliers.Slap Hammer.....	455
Bone Holding Clamps.Traction Bar.....	456
Orthopedic Drills Bitts.Burrs.Trephines.....	457-459
Remaers .Awis . Bone Hooks.....	460
Amputation Saw . Gigli Saw.....	461
Orthopedic Dressing - Plaster Instruments.....	462-463

Orthopaedics



REIL
09-352-170
17 cm



REDUCTION FORCEPS
09-353-200
20 cm



09-354-170
17 cm



09-355-130
13 cm



LEWIN

09-356-175
17.5 cm



REDUCTION
09-357-130
13 cm

Orthopaedics



09-358-135
13.5 cm



DINGMANN
09-359-180
18 cm



09-360-160
16 cm



09-361-220
22 cm



PATELLA
09-362-185
18.5 cm



09-363-160 16 cm
09-364-240 24 cm
with Tread Lock

21/45

Orthopaedics

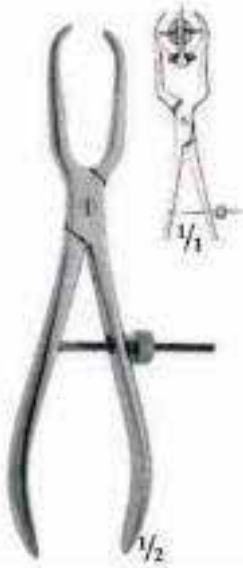

REPOSITION
09-365-230
23 cm



HEY GROVES
09-366-210 21 cm
09-367-270 27 cm
09-368-300 30 cm



LANE
09-369-330 33 cm
09-370-470 47 cm



LANE
09-371-330 33 cm
09-372-470 47 cm



KERN
09-373-160 16 cm with ratchet
09-374-210 21 cm with ratchet
09-375-160 16 cm without ratchet
09-376-210 21 cm without ratchet



FARABEUF-LAMBOTTE
09-377-230 23 cm with ratchet
09-378-260 26 cm with ratchet
09-379-230 23 cm mm without ratchet
09-380-260 26 cm mm without ratchet

Orthopaedics



LOWMANN
09-412-130 13.0 cm
09-413-185 18.5 cm
09-414-300 30.0 cm



LOWMANN-HOGLUND
09-415-175
17.5 cm

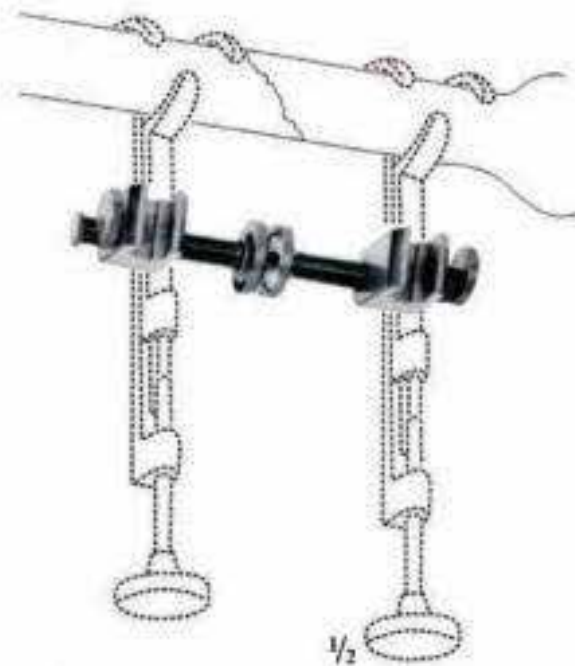

GERSTER
09-416-180 Blad Jaw 18 cm
09-417-200 Blad Jaw 20 cm
09-418-220 Blad Jaw 22 cm

Orthopaedics



SELF-CENTERING

09-384-150
For small Fragments 15 cm, jaw 8 mm
09-385-190
19 cm, Extra small jaw 10 mm
09-386-240
24cm, small jaw 14 mm
09-387-260
26 cm, medium jaw 18 mm
09-388-280
28 cm, large jaw 23 mm



ULRICH
09-389-190 19 cm
09-390-230 23 cm
09-391-250 25 cm
09-392-280 28 cm



LAMBOTTE
09-393-220 22 cm
09-394-270 27 cm
09-395-330 33 cm



09-396-200
20 cm



SEMB
09-397-190
19 cm



FERGUSON
09-398-230
23 cm



FERGUSON
09-399-210
21 cm

Orthopaedics



VERBRUGGE
09-400-180
18 cm



VERBRUGGE
09-401-180
18 cm



VERBRUGGE
09-402-250 25 cm
09-403-260 26 cm
09-404-270 27 cm



VERBRUGGE
09-405-250 25 cm
09-406-260 26 cm
09-407-270 27 cm



VERBRUGGE
09-408-180
18 cm



VERBRUGGE
09-409-250 25 cm
09-410-260 26 cm
09-411-270 27 cm

Orthopaedics



PLASTER-BRUNS
09-571-240
24 cm
Saw Edge



SEUTIN
09-572-230
23.0 cm



BOHLER
09-573-180 18 cm
09-574-240 24 cm



1/2

STILLE
09-575-200 20 cm
09-576-230 23 cm
09-577-260 26 cm
09-578-370 37 cm



1/2

HENNIG
09-579-280
28 cm



1/1

09-580-230
23 cm
3 Prognng

MODEL USA

Orthopaedics

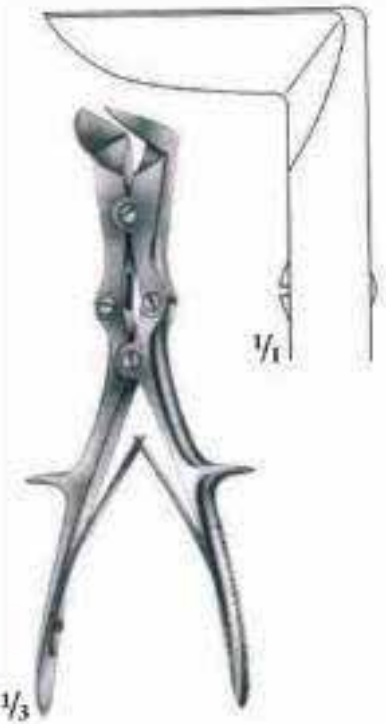

LISTON-STILLE
09-475-260
26 cm



McINDOE
09-476-175
17.5 cm



BOHLER
09-477-150 15 cm straight
09-478-150 15 cm curved



RUSKIN
09-479-200
20 cm



HORSLEY
09-480-250
25 cm



LISTON-KEY (HORSLEY)
09-481-270
27 cm
Angled, 28 mm

Orthopaedics

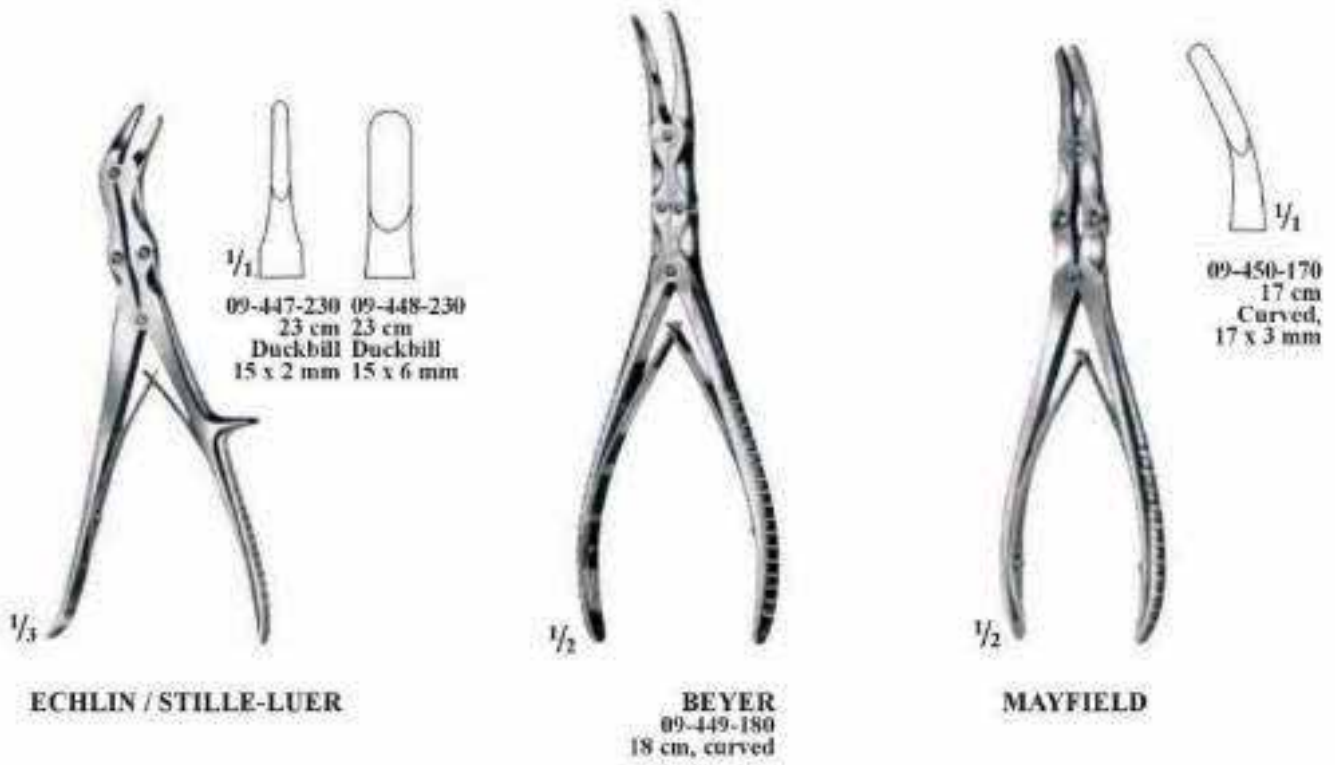
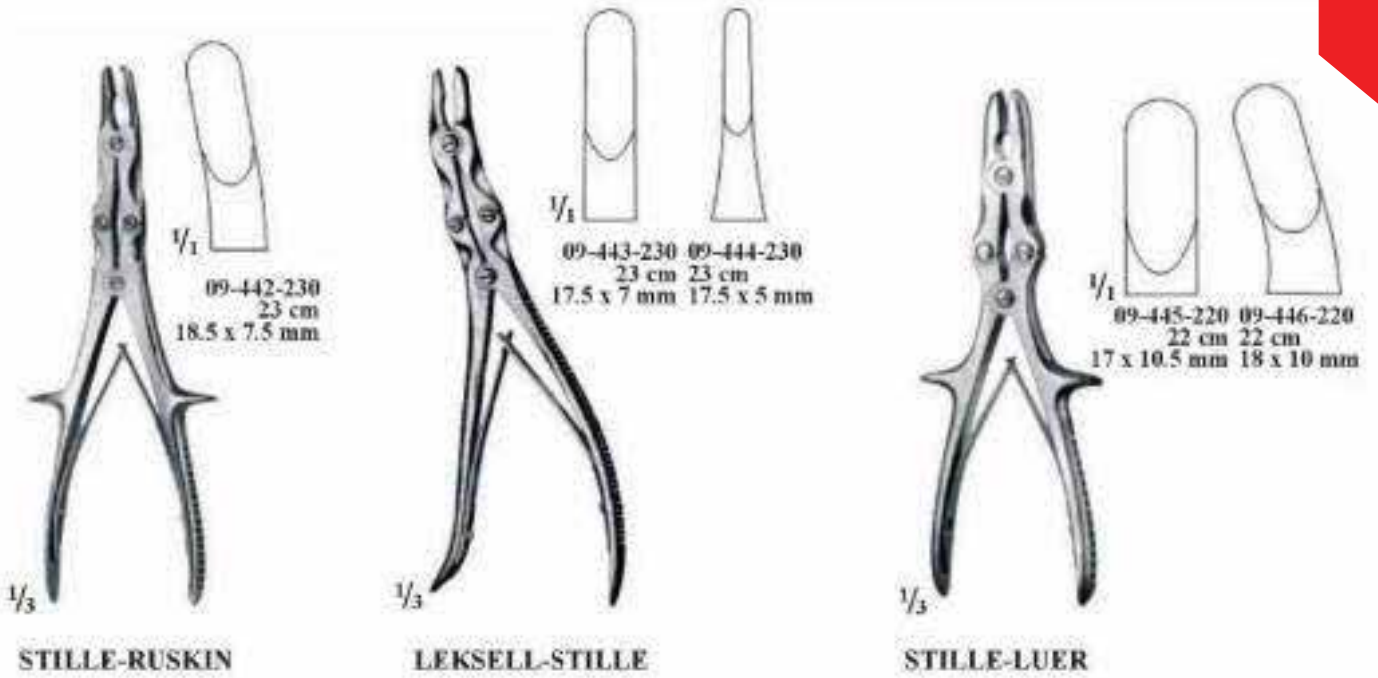

Orthopaedics

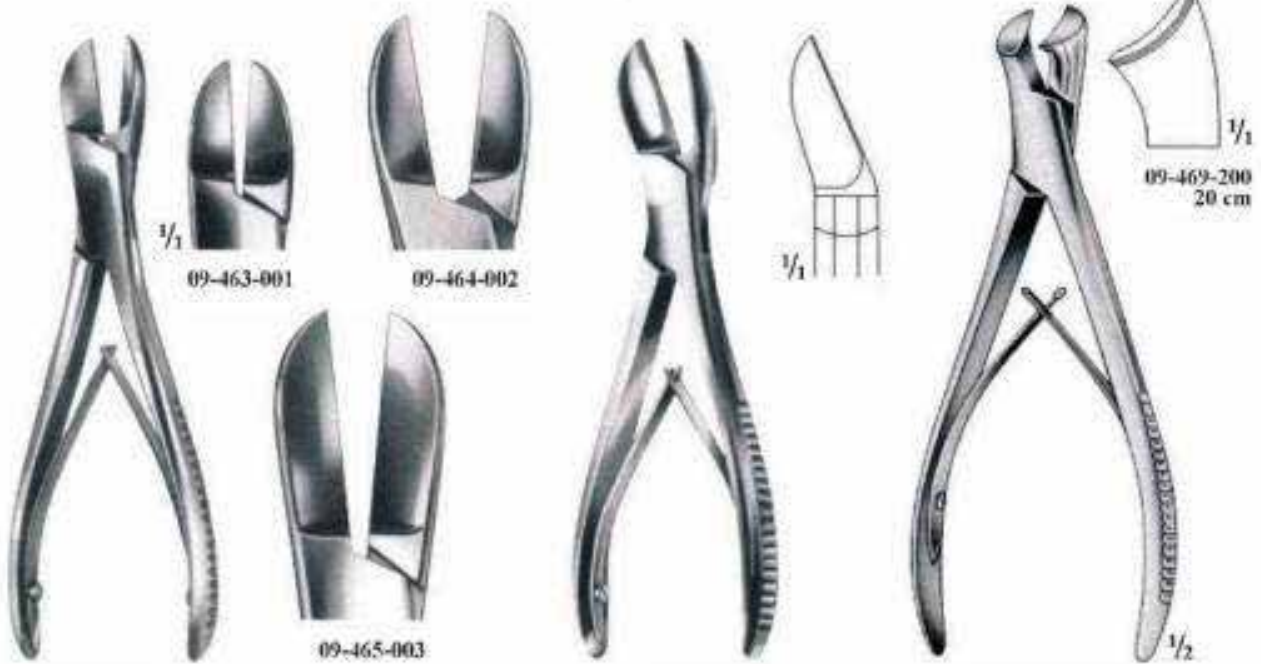

LISTON
09-462-180
18 cm

LISTON
09-466-170 17 cm
09-467-190 19 cm
09-468-220 22 cm
curved on flat

MARKWALDER
09-469-200
20 cm

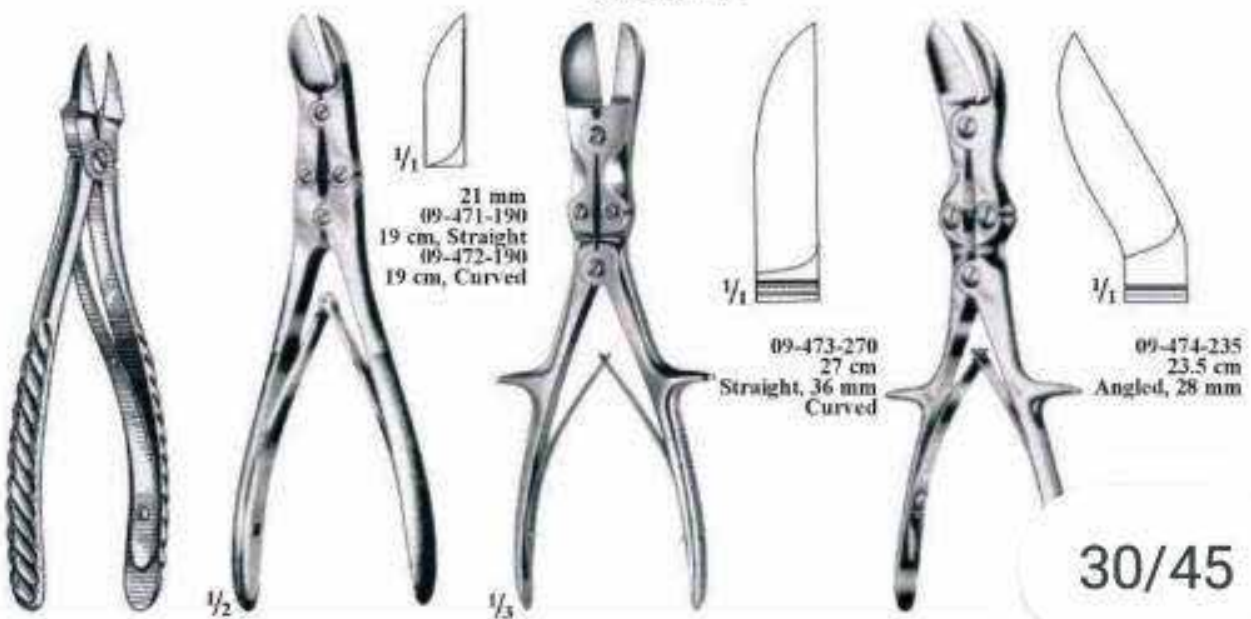

DURAY STAMM
09-470-150
15 cm

RUSKIN-LISTON
09-471-190
19 cm, Straight
09-472-190
19 cm, Curved

STILLE-LISTO
09-473-270
27 cm
Straight, 36 mm
Curved

LISTON
09-474-235
23.5 cm
Angled, 28 mm

30/45

Orthopaedics



09-551-150
15 cm



DIAMANT PIN CYTTER
09-552-160
16 cm



09-553-220
22 cm



09-554-320
32 cm
3.0 mm, 3.0 mm



09-555-235
23.5 cm



09-556-140
14 cm
1.2 mm



09-557-240
24 cm

Orthopaedics

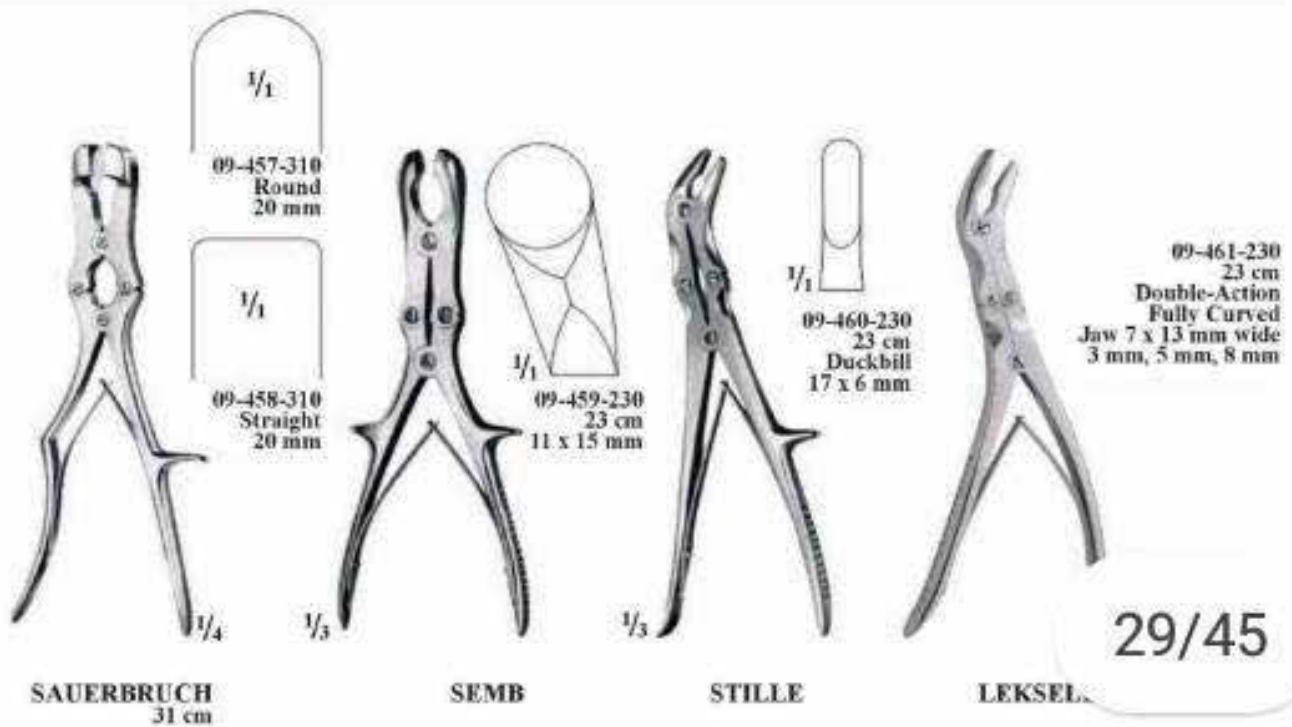
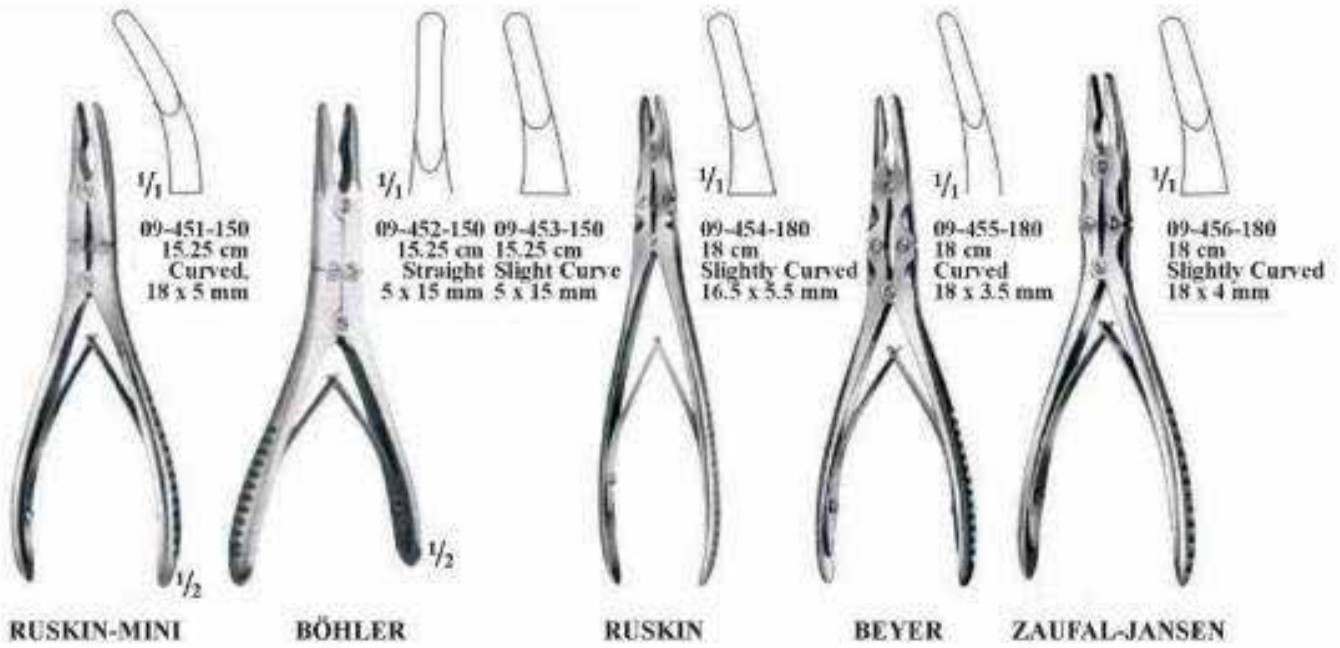

29/45

Orthopaedics



EXTRACTION PLIERS
09-588-180 18 cm
09-589-180 18 cm

EXTRACTION PLIERS
09-590-200 20 cm

EXTRACTION PLIERS
09-591-200 20 cm

EXTRACTION PLIERS



WIRE CUTTERS
09-594-180 18 cm



WIRE CUTTERS
09-595-180 18 cm
09-596-210 21 cm



WIRE CUTTERS
09-597-180 18 cm

Orthopaedics



UNIVERSAL SCISSORS
09-598-100 10 cm
09-599-120 12 cm



WIRE CUTTER $\frac{1}{2}$
09-600-180
18 cm



WIRE CUTTERS
09-601-180
18 cm $\frac{3}{4}$



$\frac{1}{4}$ **WIRE CUTTERS**
09-602-460 46 cm
09-603-560 56 cm



WIRE CUTTERS $\frac{1}{2}$
09-604-180 18 cm
09-605-220 22 cm



$\frac{1}{1}$
2.0 mm
1.6 mm



09-606-240
24 cm $\frac{1}{2}$

Needle Holders with Tungsten Carbide Inserts



1/2
26-172
Mathieu-Ryder
17cm
20cm 24cm



1/2
26-173
Lichtenberg
20cm



1/2
26-174
Langhals
20cm 25cm



1/2
26-175
Lichtenberg
20cm 25cm



1/2
26-176
Luehty-Beck
20cm 25cm



1/2
26-177
Luehty-Beck
20cm 25cm



1/2
26-178
Langebeck
18cm
20cm 23cm



1/2
26-179
Langebeck-beck
18cm
20cm 23cm

Needle Holders with Tungsten Carbide Inserts



Needle Holders with Tungsten Carbide Inserts



26-159
Bozemann-Wertheim
20cm 24cm 26cm



26-160
Stratte
22cm 23cm

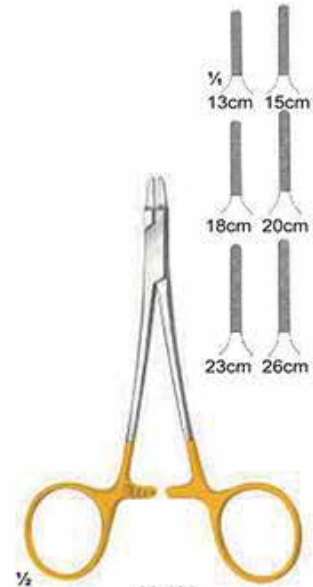

26-161
Ryder
13cm 15cm 18cm
20cm 23cm 26cm



26-162
Ryder-Vascular
13cm 15cm 18cm
20cm 23cm 26cm



26-163
Martin
15cm 17cm 20cm



26-164
Sarot
18cm 20cm 26cm

Needle Holders with Tungsten Carbide Inserts



26-152
Arruga
16cm



26-153
Castroviejo
13cm



26-154
Hegar
20cm 24cm

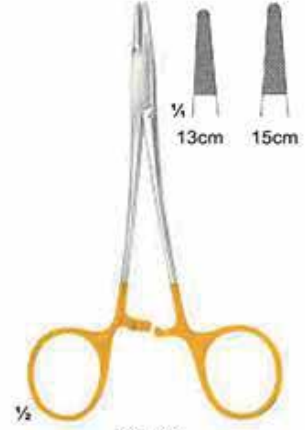

26-155
Halsey
13cm 15cm



26-156
Mayo-Hegar
16cm 18cm 20cm
24cm 26cm 30cm



26-157
De-Bakey
18cm 20cm 23cm
26cm 31cm 37cm



26-158
Hegar-Vascular
14cm 18cm
20cm 23cm

Dissecting Forceps and Needle holders with Tungsten Carbide Inserts



26-144
Wangensteen



26-145
Potts-Smith

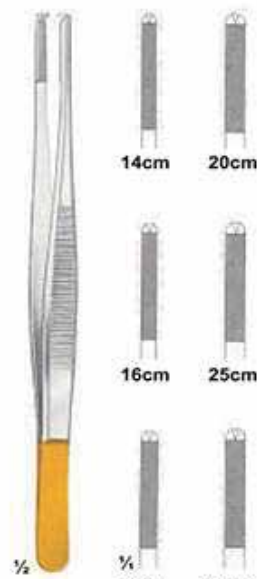

26-146
Oehler



26-147
Potts-Smith
22cm



26-148
Hepp-Scheidle
18cm



26-149
Castroviejo
14cm



26-150
Castroviejo
14cm



26-151
Arruga
16cm

Scissors & Dissecting Forceps with Tungsten Carbide inserts

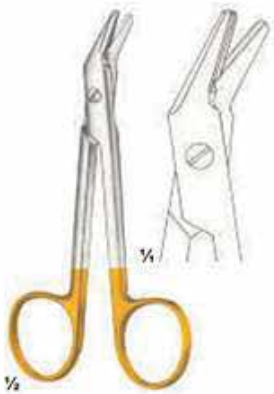

26-136
Universal
12cm



26-137
Ligature Scissors
1 Black & 1 Goldplated ring

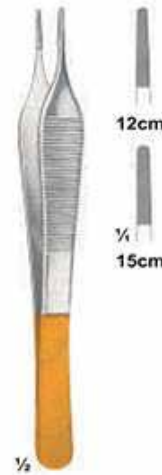

26-138
Adson



26-139
Cushing
17,5cm



26-140
Cushing
18cm



26-141
Cushing-Taylor
18cm



26-142
Dissecting Forceps
15cm



26-143
Semken
15cm

Scissors with Tungsten Carbide Inserts

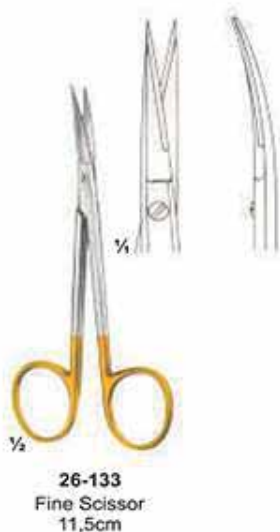

Scissors with Tungsten Carbide Inserts

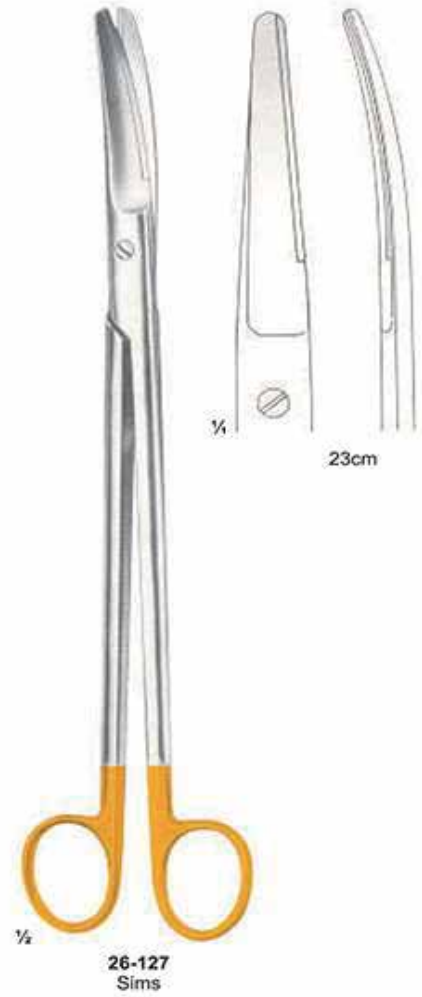
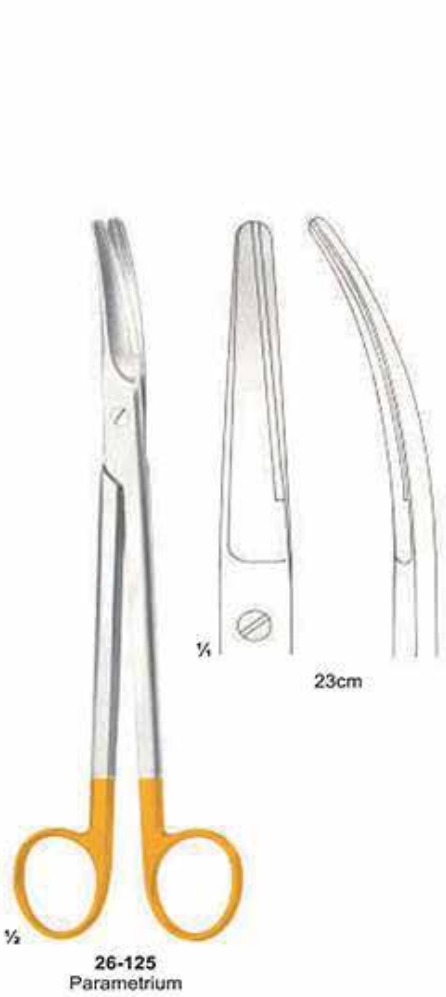

Scissors with Tungsten Carbide Inserts

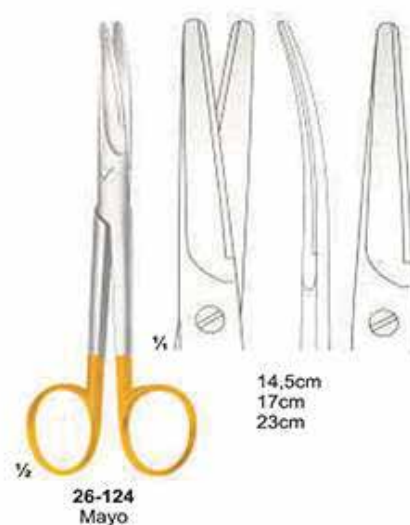

Scissors with Tungsten Carbide Inserts



Scissors with Tungsten Carbide Inserts



Scissors with Tungsten Carbide Inserts



Combined Suction and Irrigation Cannulae



**25-179
YASARGIL**
LURE-LOCK cone
200 mm

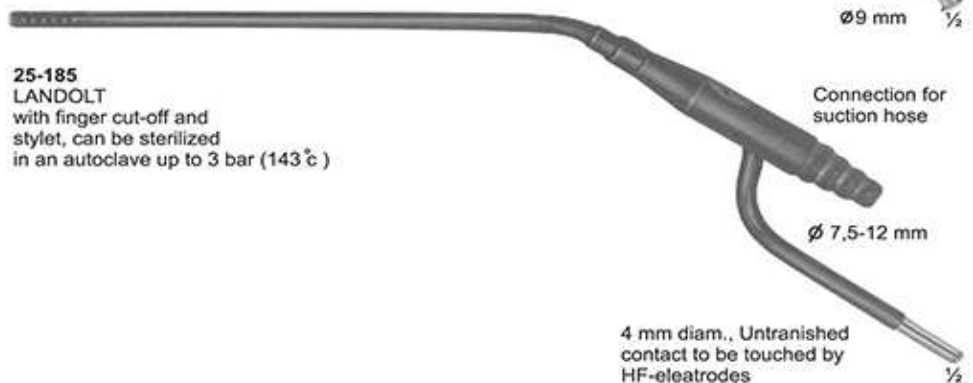
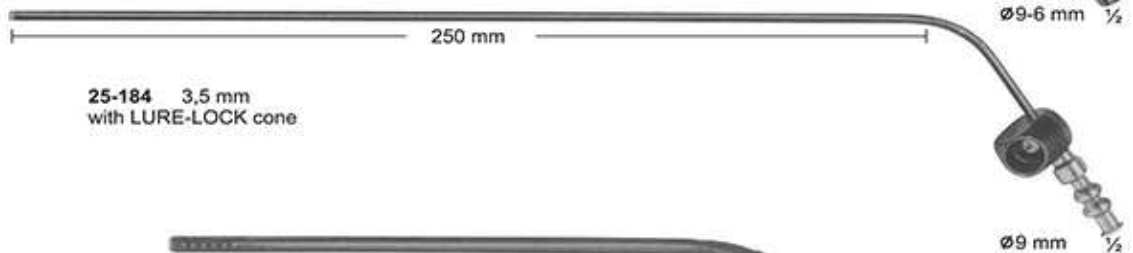
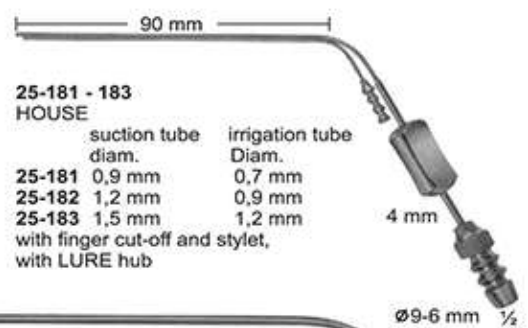
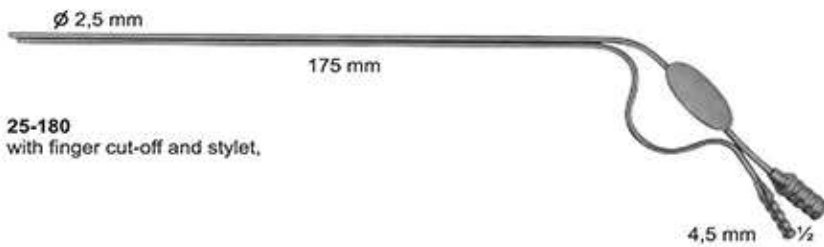

Suction Instruments

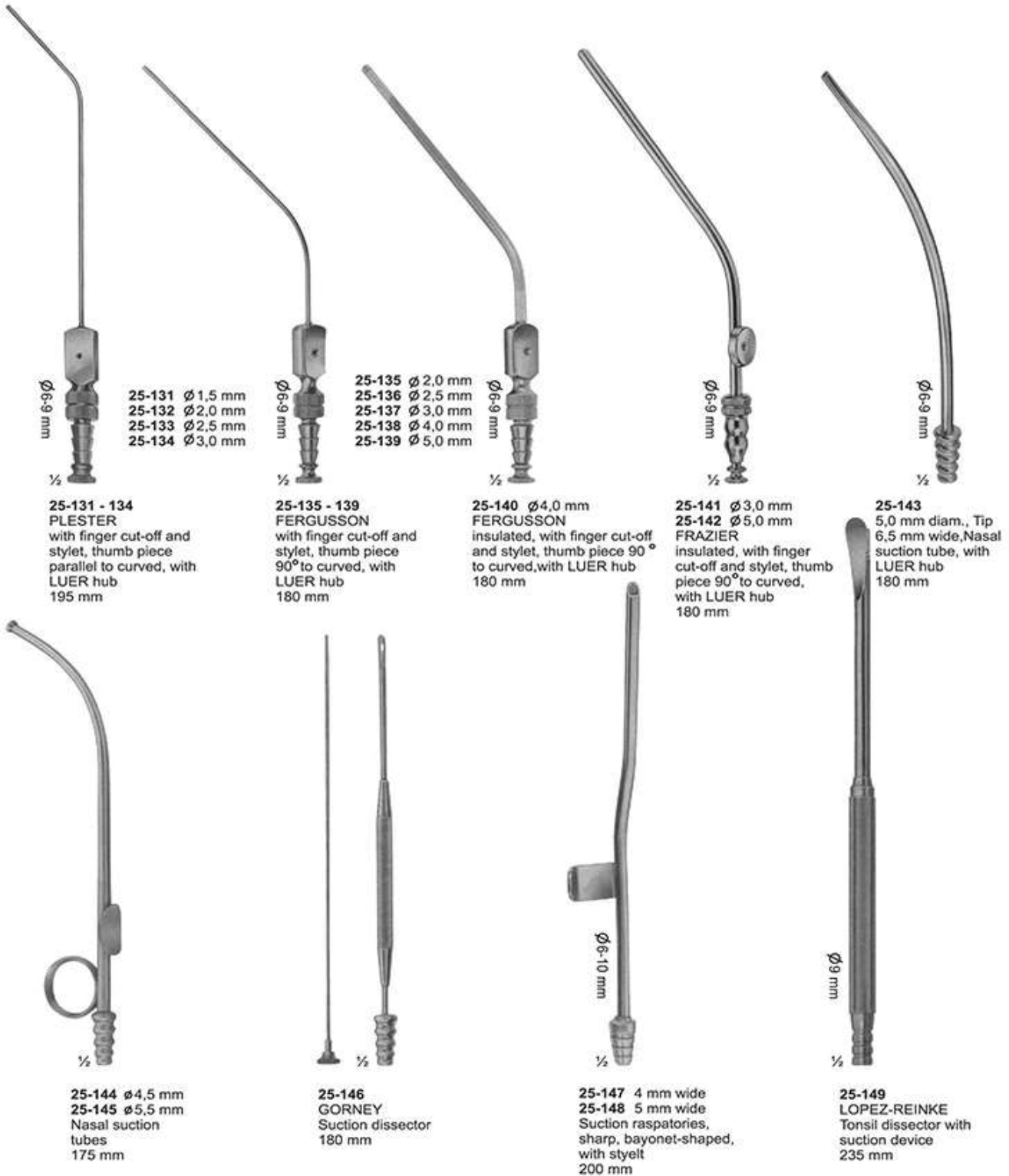

Suction Instruments



22-125
YANKAUER
with especially large
central bore, 4,8 mm
diam.
285 mm



22-126
YANKAUER
with central bore,
2,0 mm diam.
285 mm



22-127
DE-BAKEY
with central bore,
3,0 mm diam.with
lateral slots
275 mm



22-128
DE-BAKEY
with finger cut-off
and stylet
270 mm



22-129
DE-BAKEY
with finger cut-off
and stylet
160 mm



22-130
with finger
cut-off
190 mm

Suction Instruments

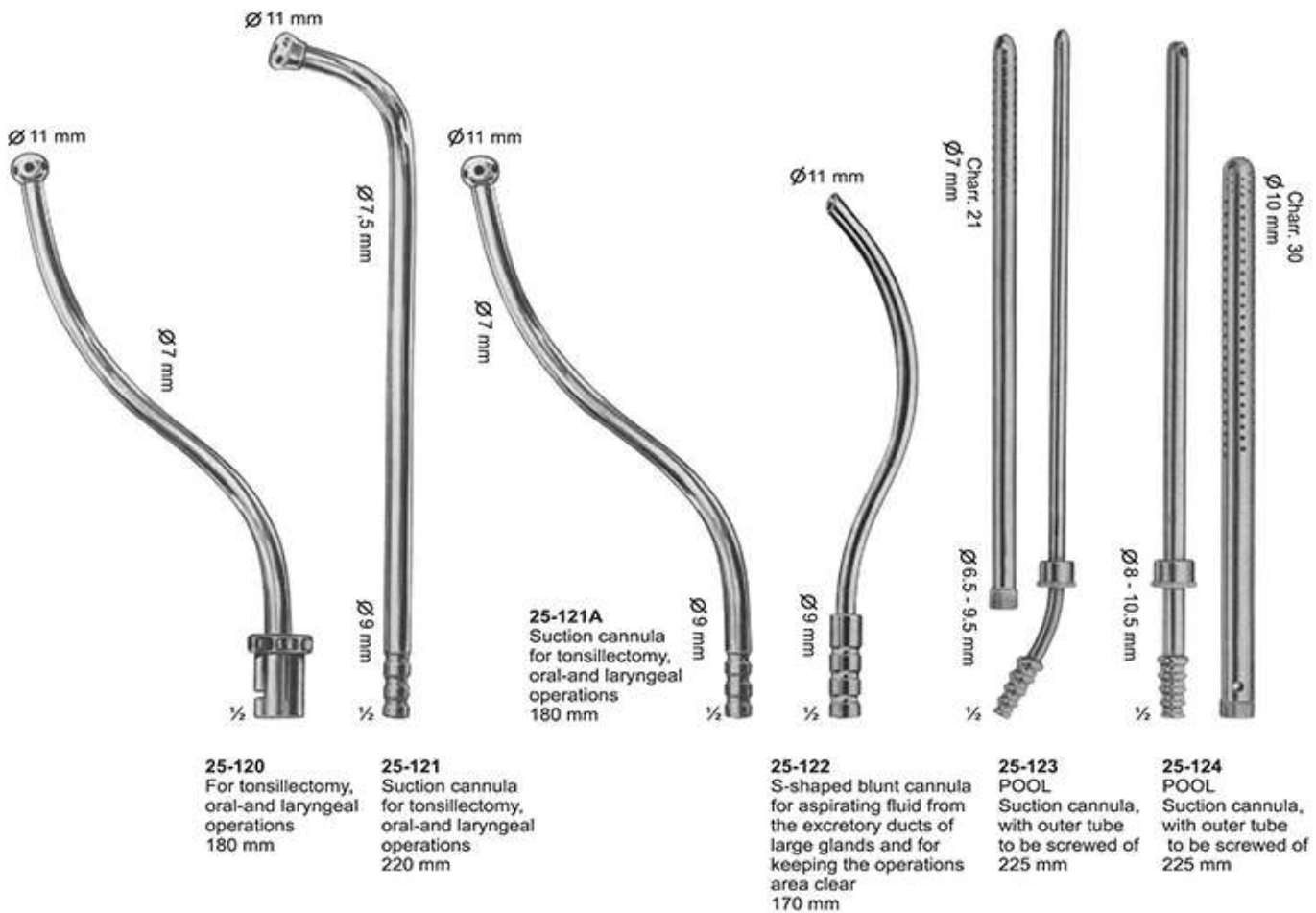

Suction Instruments



25-115
Trocar
For puncturing
170 mm



25-116
Hollow needle,
sharp
150 mm



25-117
double curved
For general
surgery
230 mm



25-118
For tonsillectomy,
oral and laryngeal
operations
190 mm



25-119
For tonsillectomy,
oral and laryngeal
operations
220 mm

Vacuum Currettes for Aspiratin Lipectomy, Suction Instruments

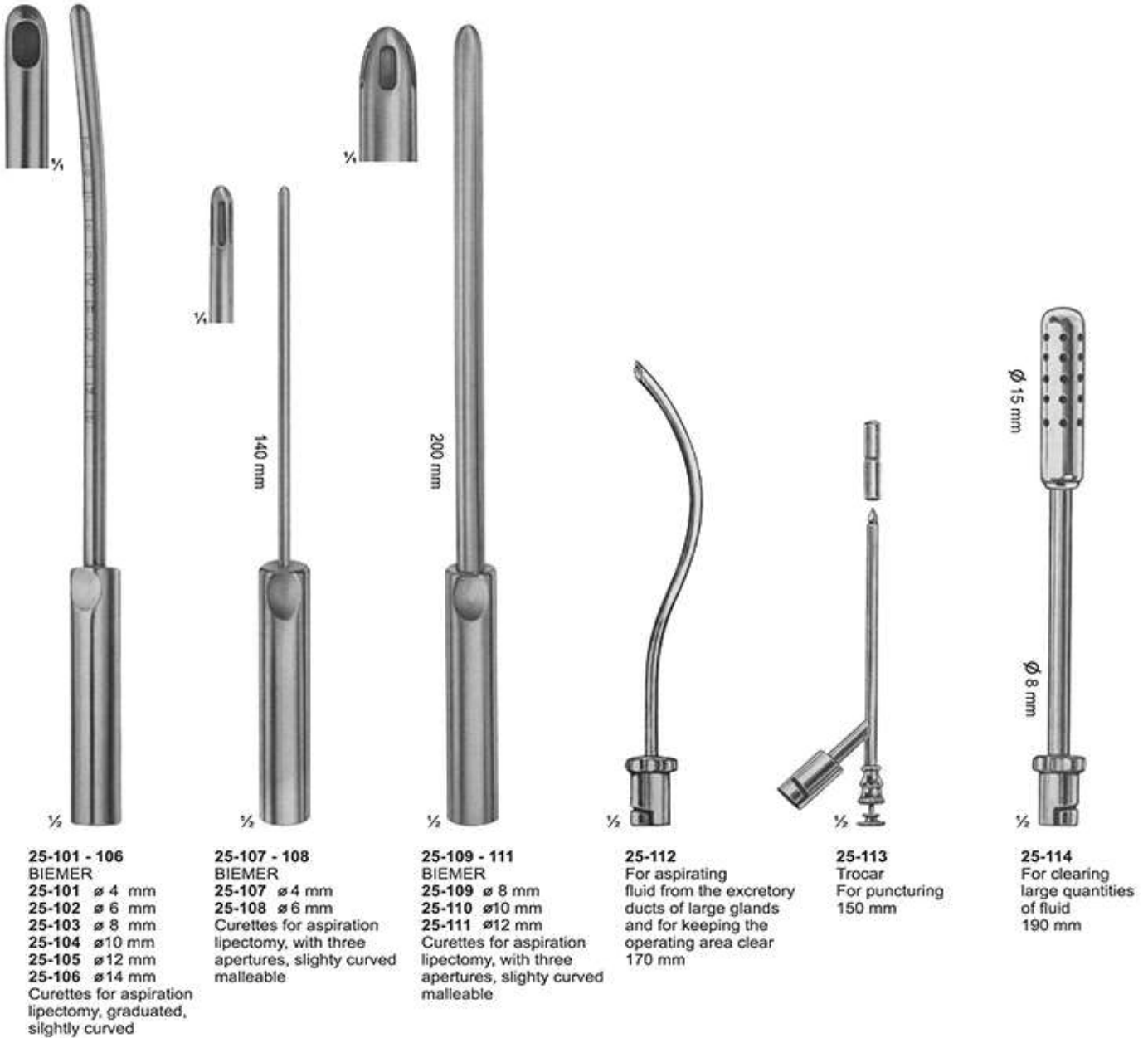

STILLE Plaster Shears

Blade with reinforced back



24-131
STILLE
230 mm

24-132
Spare blade



24-133
STILLE
370 mm

24-134
Spare blade



24-135
STILLE
240 mm

24-136
Spare blade

Plaster Shears



24-129
STILLE-AESCULAP
260 mm

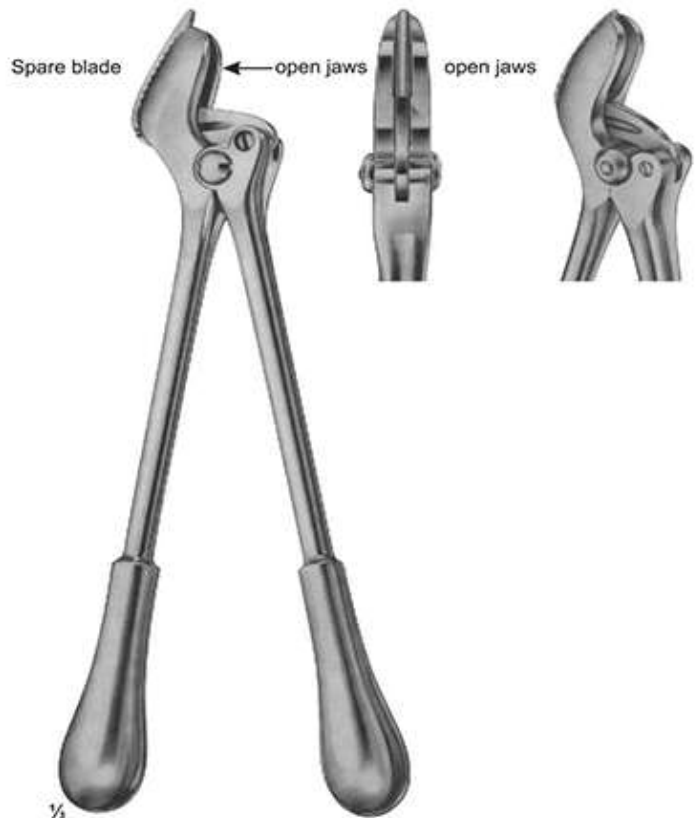

24-130
STILLE-AESCULAP
360 mm

Plaster Scissors

For small plaster dressings



Plaster Instruments



24-101
HOPKINS
200 mm



24-102
ESMARCH
180 mm



24-103
ENGEL
160 mm



24-104 - 112

- | | |
|---------------------|---------------------------|
| 24-104 black | 24-108 yellow |
| 24-105 red | 24-109 white |
| 24-106 blue | 24-110 orange |
| 24-107 green | 24-111 lavender |
| | 24-112 bright pink |



24-113 - 121

- | | |
|---------------------|---------------------------|
| 24-113 black | 24-117 yellow |
| 24-114 red | 24-118 white |
| 24-115 blue | 24-119 orange |
| 24-116 green | 24-120 lavender |
| | 24-121 bright pink |

Finger Nail Instruments

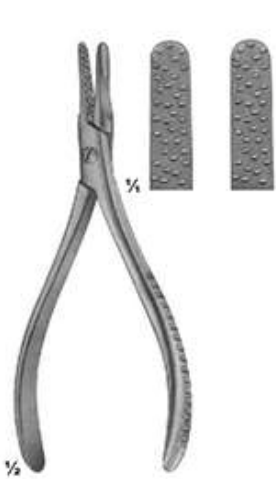

23-202
Nail extracting
forceps
135 mm



23-203
Nail extracting
forceps
145 mm



23-204 - 206
Finger nail drill
with 3 points

Drill points only

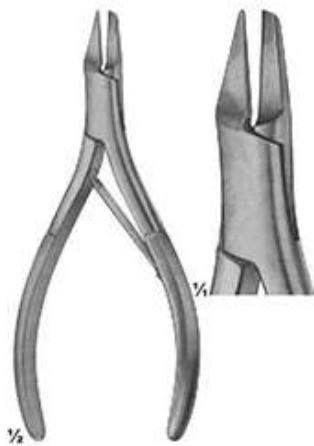

23-207
Nail splitting
forceps
135 mm



23-208
SYSTRUNK
Scissors, for splitting
finger nails
130 mm



23-209
Finger ring saw
150 mm

Spare blade

Wire Cutting Pliers



Cutter for cutting off KIRSCHNER wires, Tibia head screws, bolts, pins, up to 3 mm diam.

23-200
320 mm

for soft wire up to diam. 3,0 mm
For hard wire up to diam 3,0 mm



Durotip

23-201
Cutter for cutting off KIRSCHNER wires, Tibia head screws, bolts, pins, up to 6 mm diam, 470 mm

Wire Holding forceps, Flat-nosed Pliers, Pliers for bending and cutting wires

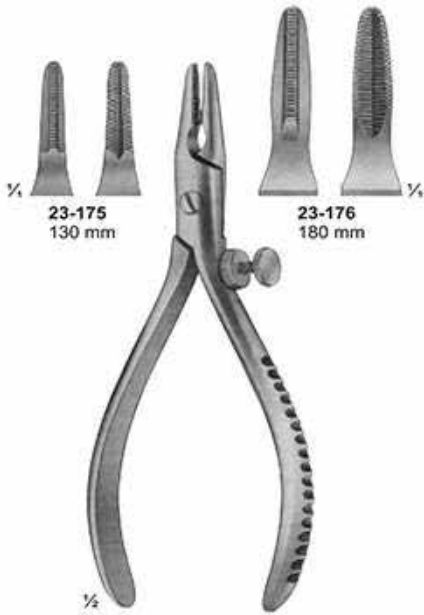

23-175 - 176
Extraction pliers for boring wires

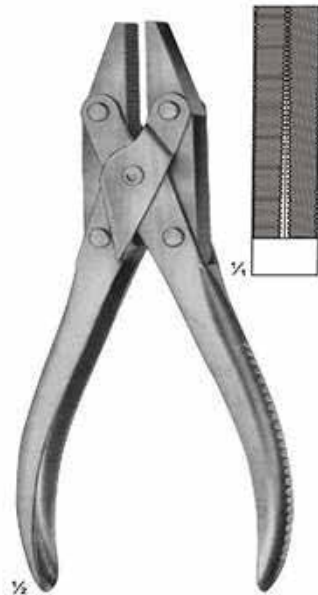

23-177
Flat-nosed pliers, parallel 185 mm

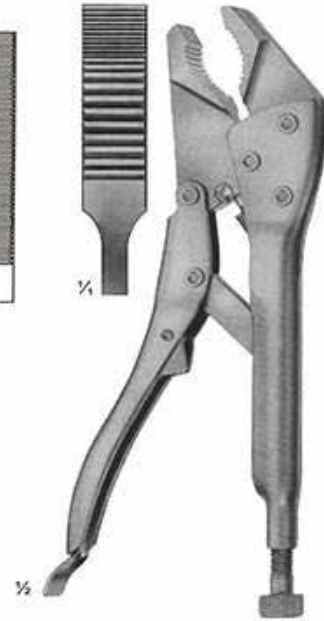

23-178
Vise grip 200 mm



23-179 - 183
Round pliers 180 mm

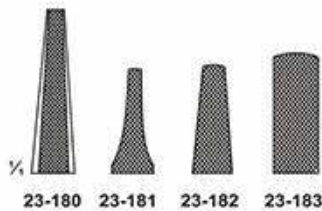

23-180
23-181 145 mm
23-182 180 mm
23-183 180 mm
Extraction pliers for wires

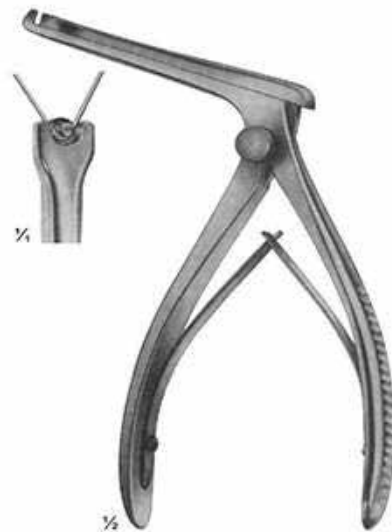

23-184
Bending pliers for wires up to 1.8 mm diam.

Wire Holding forceps, Flat-nosed Pliers, Pliers for bending and cutting wires



23-167
DUROGRIP
Holding forceps for cerclage wire, with lateral jaws to avoid wire slipping off
170 mm



23-168
DUROGRIP
Wire, tightening pliers. Ligature pliers
150 mm



23-169
DUROGRIP
Wire, tightening pliers. Ligature pliers
150 mm



23-170
with serrated jaws
140 mm



23-171
one jaws smooth, one jaws serrated
140 mm



23-172
with serrated jaws
23-173
with longitudinal and transversal grooves
170 mm



23-174
190 mm

JORDAN instruments for subcutaneous Tibia Cerclage



23-163
JORDAN
Wire tightener



$\frac{1}{2}$
23-164
JORDAN
Wire twister
170 mm



$\frac{1}{2}$
23-165
JORDAN
Wire catcher
180 mm



$\frac{1}{2}$
23-166
JORDAN
Probe, cannulated
170 mm

Cerclage Instruments

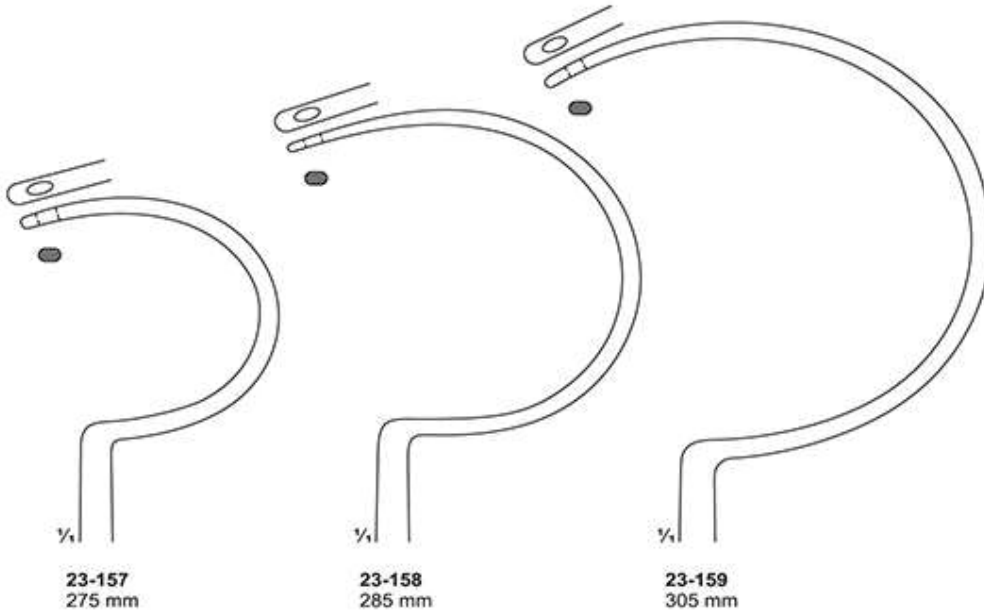

23-157 - 159
DEMEL
Wire guides

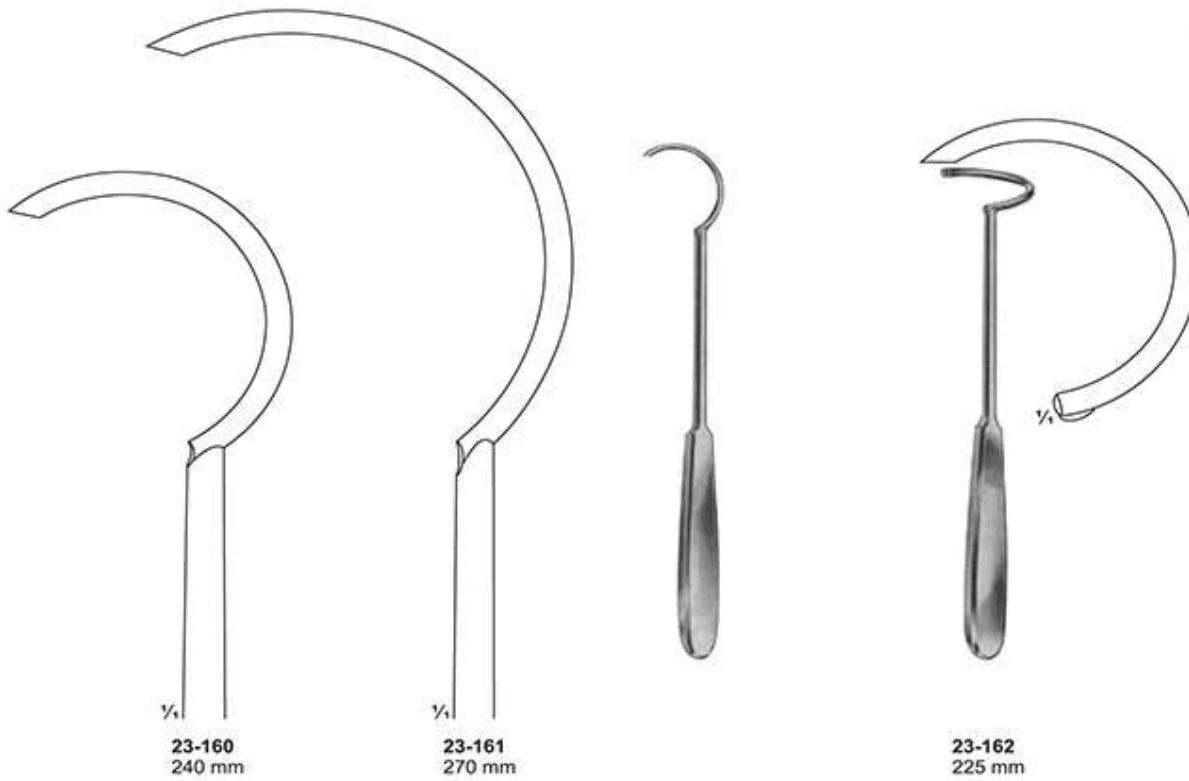

Drilling Chucks



23-150
REILL
Drilling chuck,
cannulated,
for shanks from
2.0 - 2.5 mm diam
115 mm



23-151
Drilling chuck,
cannulated,
for shanks from
0.8 - 2.0 mm diam
150 mm



23-152
Drilling chuck,
cannulated,
for shanks up to
4.5 mm diam
with key
140 mm



23-153
LOUTE
Wire tightener, improved pattern,
with movable tip,
for wires up to 1.0 mm diam.
220 mm



23-154
Drilling chuck, cannulated,
for shanks up to 6.35 mm diam.,
To be tightened by hand
100 mm



23-155
Drilling chuck, cannulated,
for shanks up to 4.5 mm diam.,
And for triangular shaft width
across flats 4.7 mm



23-156
Drilling chuck, cannulated,
for shanks up to 6.35 mm diam.,
With key
160 mm

STEINMANN Pins



23-133 - 147
STEINMANN
 triangular shaft ended and trocar point

Length	4,0 mm	5,0 mm
80 mm	23-133	
100 mm	23-134	
120 mm	23-135	
140 mm	23-136	
150 mm	23-137	23-143
160 mm	23-138	
180 mm	23-139	23-144
200 mm	23-140	23-145
210 mm	23-141	
250 mm	23-142	23-146
300 mm		23-147



¼

23-148
 Protection cap
 for 4,0 mm STEINMANN Pins



¼

23-149
 Protection cap
 for 5,0 mm STEINMANN Pins

Traction Bows, Distractor



Steinmann pins, 4 mm diam.		Steinmann pins, 5 mm diam.	
23-123	with pin		16x9cm Arm
23-124	without pin	23-129	without
23-125	with pin		21x11cm Arm
23-126	without pin	23-130	without
23-127	with pin		21x15cm Arm
23-128	without pin		

23-123 - 130
Screw driver, for above fixations discs



23-131
SCHWARZ
Traction bow for fingers, to be used with KIRSCHNER-wire up to 1.6 mm diam.



23-132
Small distractor as a repositioning device for distraction and compression of small bones, for wires with 3.0 mm diam.

Wire Extension

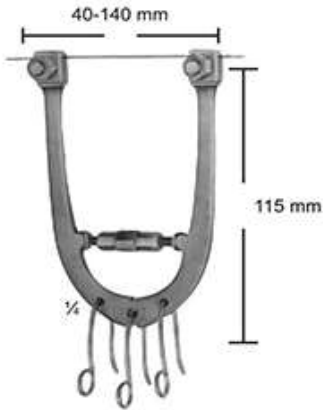

23-113
Wire traction bow, adjustable, with 3 hooks, small size

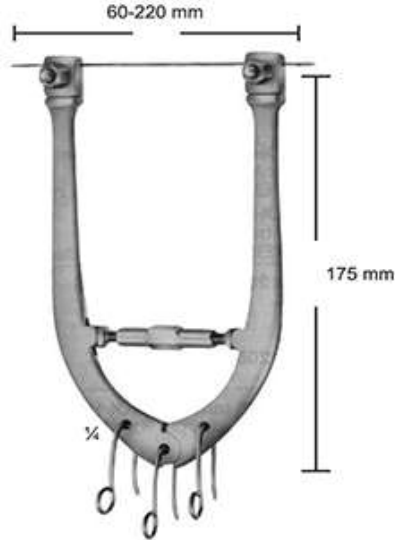

23-114
Wire traction bow, adjustable, with 3 hooks, large size



23-115
Wire traction bow, adjustable, with 3 hooks, large size for elbow and calcaneus, for adolescents



23-116	105 mm
23-117	160 mm
23-118	200 mm
23-116	1,6 mm
23-117	2,0 mm
23-118	2,5 mm

23-116 - 118
KIRSCHNER
Wire traction bow, modified adjustable in with width, holds wire securely, with 1 hook



23-119
Fixation disc, slotted



23-120
idem, aluminum, transparent to X-rays



23-121
Fixation disc, slotted



23-122
Screw driver, for above fixations discs

Wire Extension

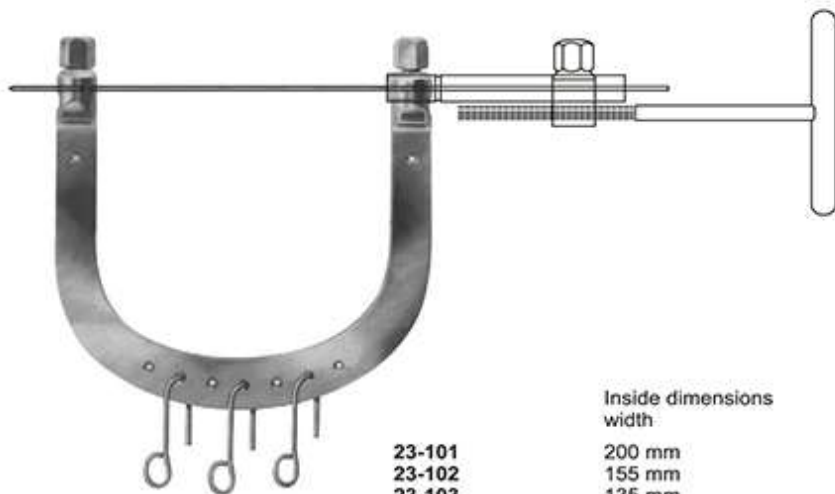

23-101 - 107
KIRSCHNER
Wire traction bows,
to be used with
KIRSCHNER-wires
up to 2.5 mm diam.,
With 3 hooks,
stainless steel

	Inside dimensions width	depth
23-101	200 mm	155 mm
23-102	155 mm	155 mm
23-103	135 mm	130 mm
23-104	120 mm	120 mm
23-105	105 mm	100 mm
23-106	95 mm	110 mm
23-107	95 mm	70 mm



23-108
Wrench, double - ended,
for wire traction bows



23-109
Wire tightener, with
clamping jaws



23-110
Traction hook only,
large size



23-111
Traction hook only,
small size



23-112
Fixation clamp, to secure clamping
jaws of stainless steel

Meniscus Knives



22-205
SALENIUS
220 mm



22-206
CHNAD. MODELL
200 mm

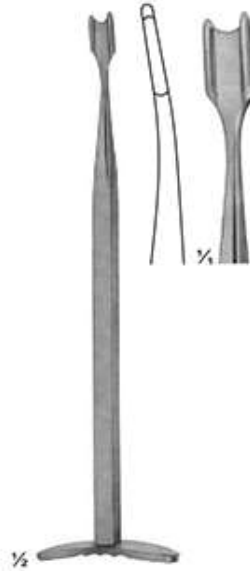

22-207
SMILLIE
170 mm

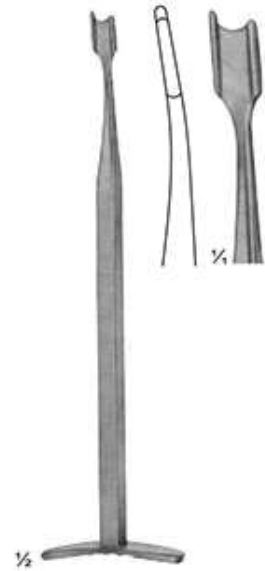

22-208
SMILLIE
170 mm

Meniscus Knives

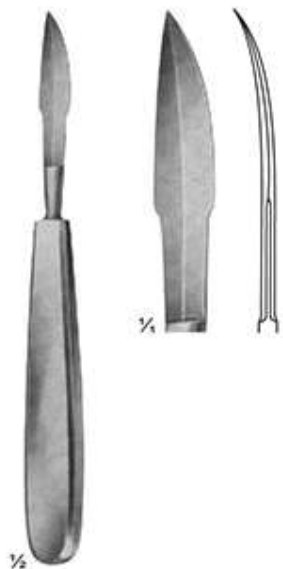

22-201
170 mm



22-202
NEFF
215 mm



22-203
NEFF
215 mm



22-204
WAGNER
215 mm

Meniscus-and Cartilage Forceps



22-195
BIRCHER
200 mm



22-196
BIRCHER
200 mm



22-197
WELLER
200 mm



22-198
BIRCHER-GANSKE
200 mm



22-199
BIRCHER-GANSKE
200 mm



22-200
MARTIN
205 mm

Bone Cutting Forceps

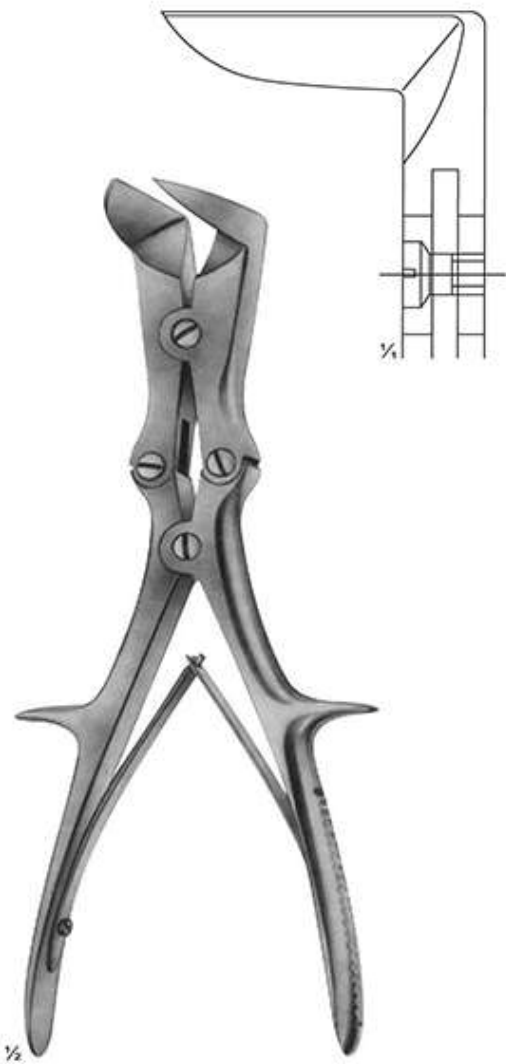

22-193
LISTON-STILLE
265 mm

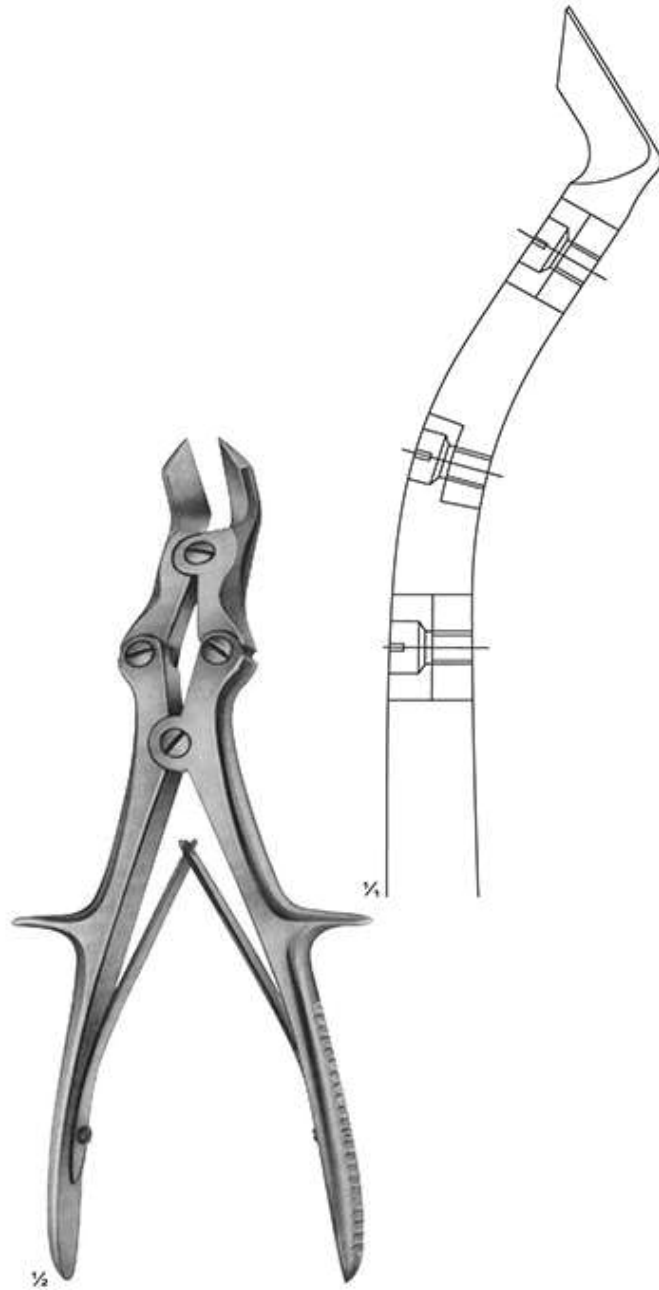

22-194
LISTON-KEY-HORSLEY
(TUDOR EDWARDS)
255 mm

Bone Rongeurs



22-174
LURE-STILLE
225 mm



22-175
LURE-STILLE
225 mm

Bone Clamps



22-133 - 134
LOWMAN
22-133 170 mm
22-134 205 mm



22-135
LOWMAN-GERSTER
210 mm







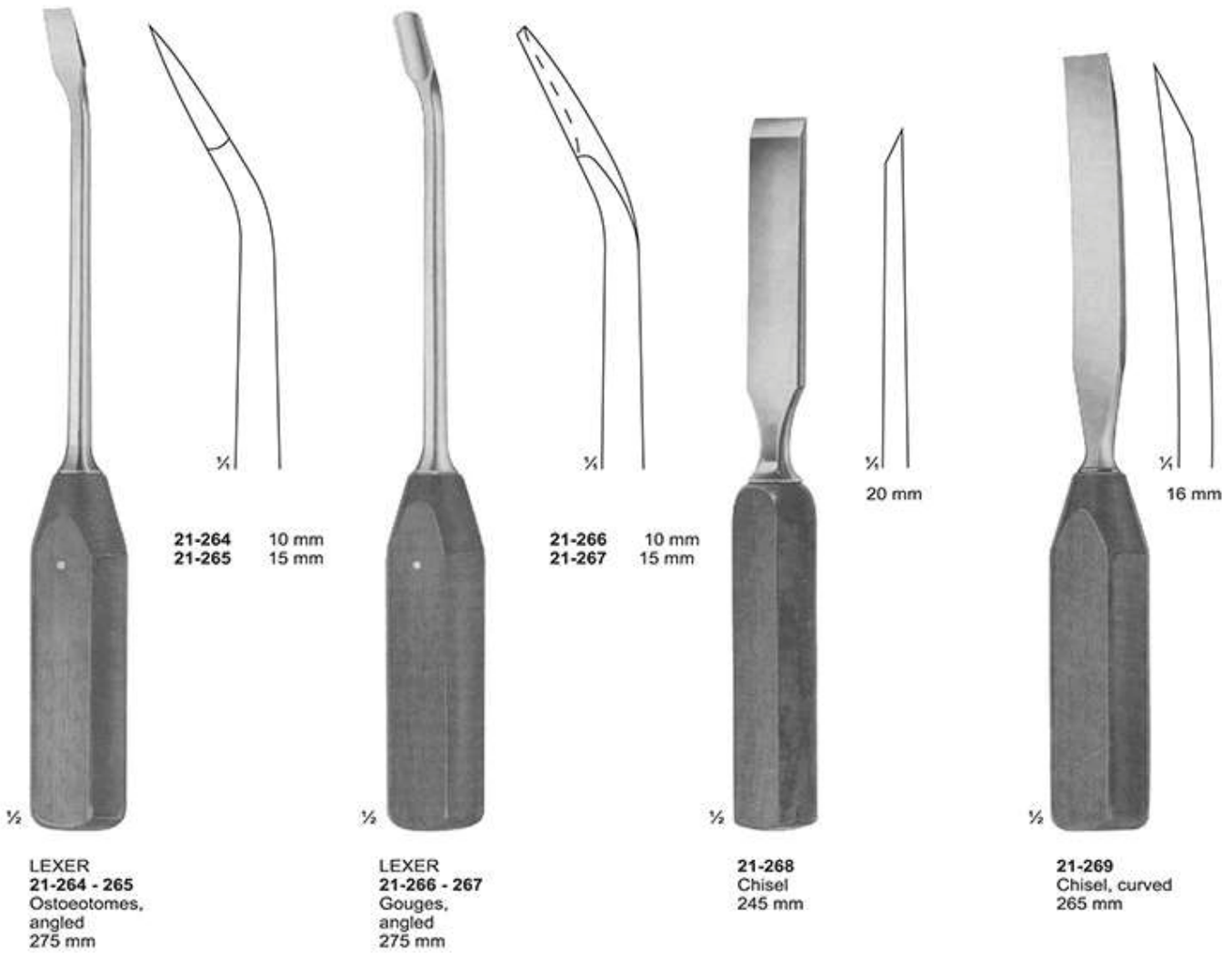





22-136
LOWMAN-HOGLUND
175 mm

Osteotomes ,Chisels and Gouges with HARTPRESS -handle

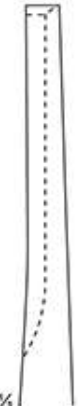

Osteotomes ,Chisels and Gouges with HARTPRESS -handle

	 <p>21-237 4 mm 21-238 6 mm 21-239 8 mm 21-240 10 mm 21-241 12 mm</p>		 <p>21-242 4 mm 21-243 6 mm 21-244 8 mm 21-245 10 mm 21-246 12 mm</p>		 <p>21-247 5 mm 21-248 7 mm 21-249 10 mm 21-250 15 mm 21-251 20 mm 21-252 25 mm 21-253 30 mm</p>
<p>LEXER-MINI 21-237 - 241 Osteotomes 180 mm</p>	<p>LEXER-MINI 21-242 - 246 Gouges 180 mm</p>	<p>LEXER 21-247 - 253 Osteotomes 220 mm</p>			
	 <p>21-254 5 mm 21-255 7 mm 21-256 10 mm 21-257 15 mm 21-258 20 mm 21-259 25 mm 21-260 30 mm</p>				 <p>21-262 5,5 mm 21-263 9,0 mm</p>
<p>LEXER 21-254 - 260 Gouges 220 mm</p>	<p>LEXER 21-261 Gouge for removing broken screws 220 mm</p>	<p>ZIELKE 21-262 - 263 Gouge for scoliose-operations 230 mm</p>			

Osteotomes

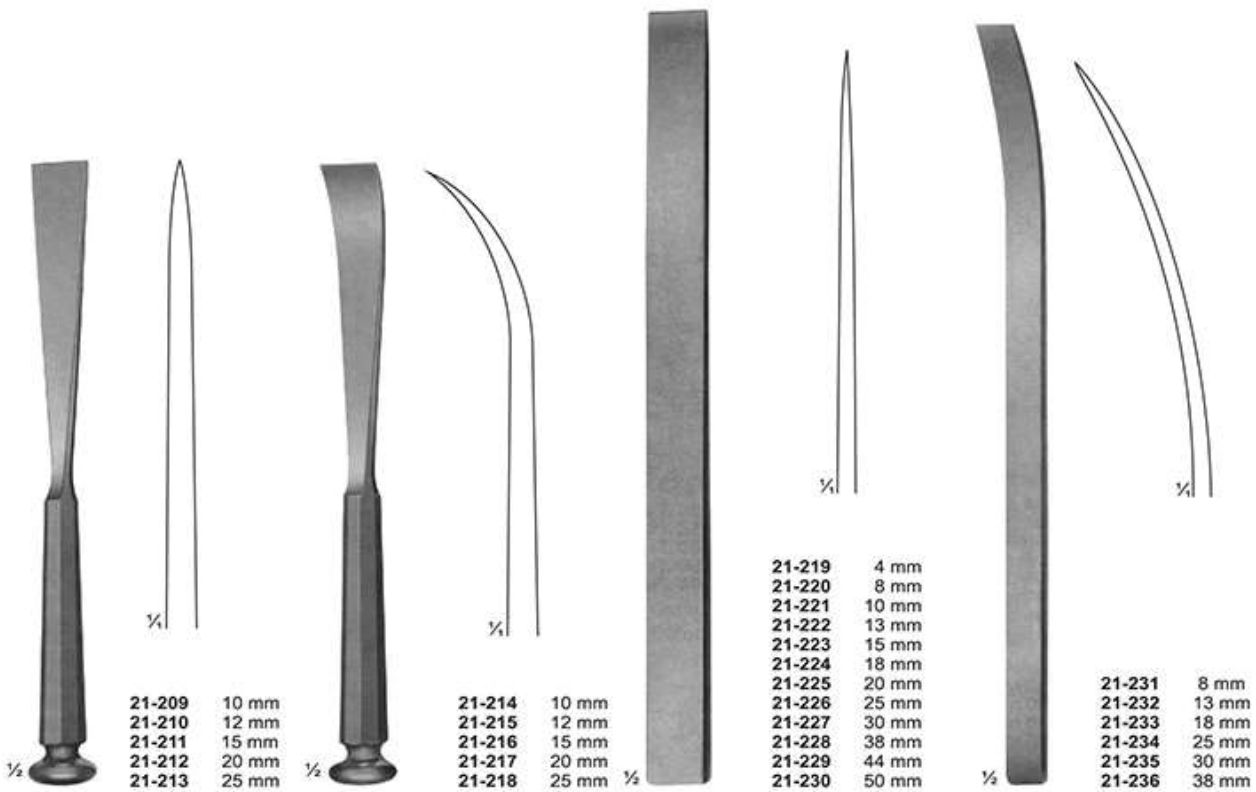

STILLE
21-209 - 213
Osteotomes
205 mm

STILLE
21-214 - 218
Osteotomes, curved
205 mm

LAMBOTTE
21-219 - 230
Osteotomes
245 mm

LAMBOTTE
21-231 - 236
Osteotomes, curved
245 mm

Osteotomes Chisels and Gouges

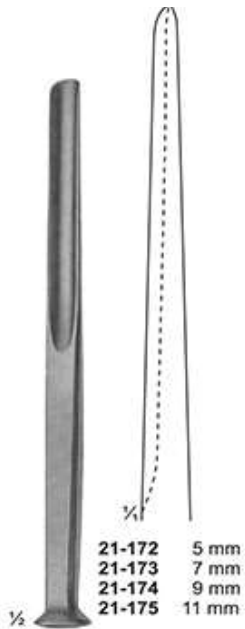

ALEXANDER
21-172 - 175
Gouges
170 mm

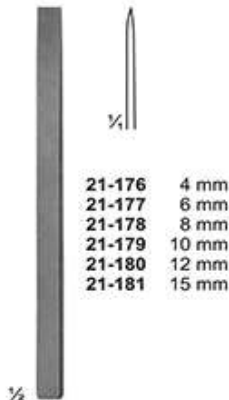

LAMBOTTE
21-176 - 181
Osteotome
125 mm

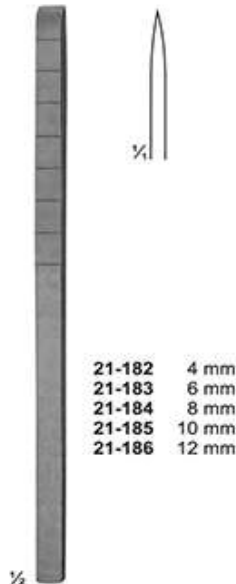

COTTLE
21-182 - 186
Osteotome with depth
markings
180 mm

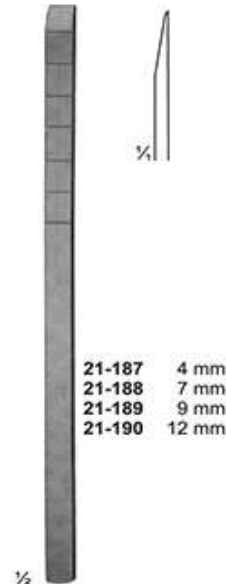

COTTLE
21-187 - 190
Chisel-Osteotomes
with depth markings
180 mm



COTTLE
21-191
Fishtail Chisel,
with protected ends
180 mm

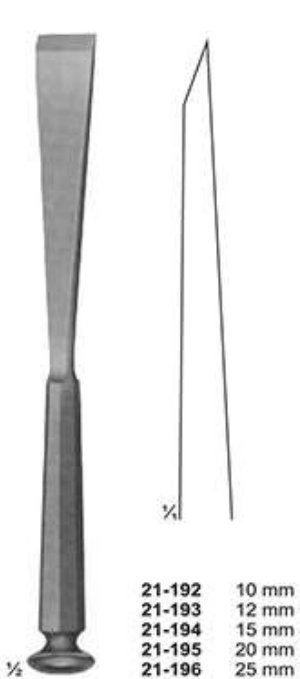

STILLE
21-192 - 196
Chisels
205 mm

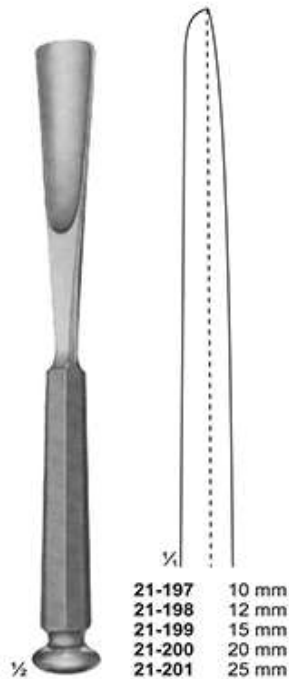

STILLE
21-197 - 201
Gouges
205 mm

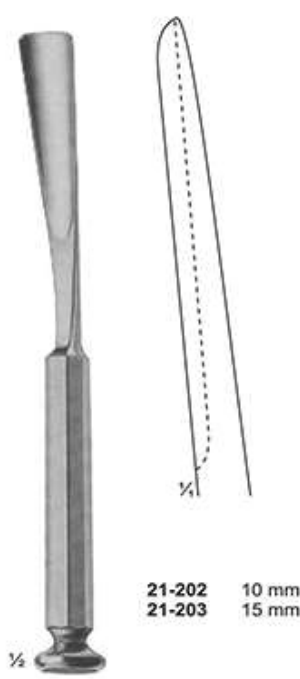

WALTER
21-202 - 203
Osteotomes
gouges for taking
grafts from the rib
205 mm



STILLE
21-204 - 208
Osteotomes
205 mm

Osteotomes Chisels and Gouges

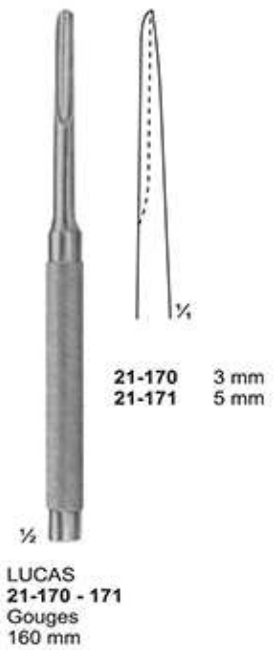
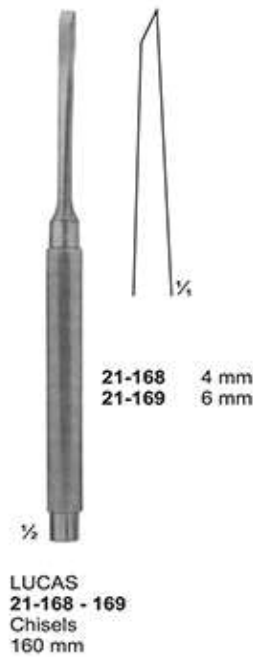
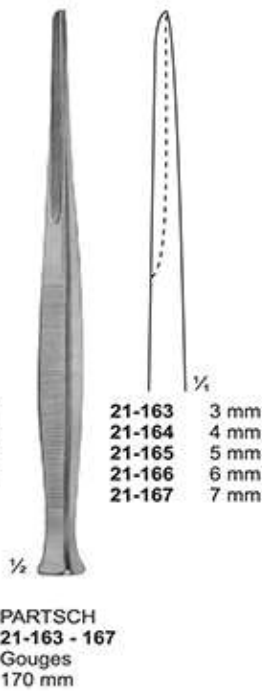
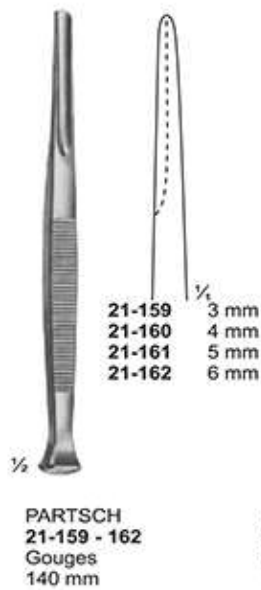
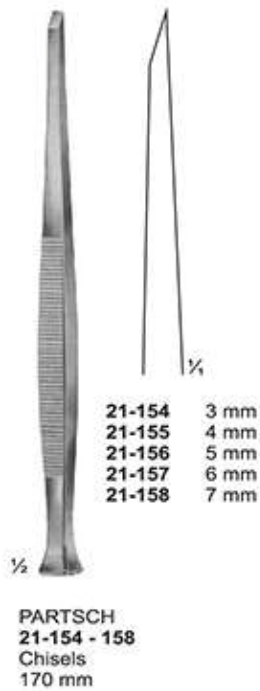
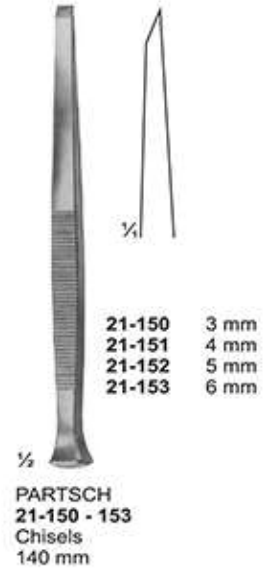
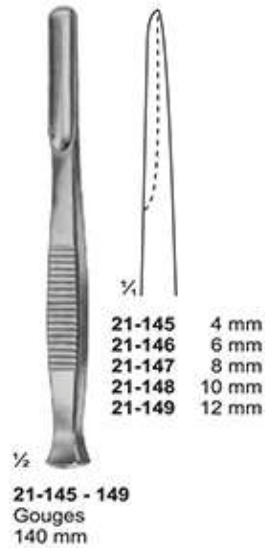
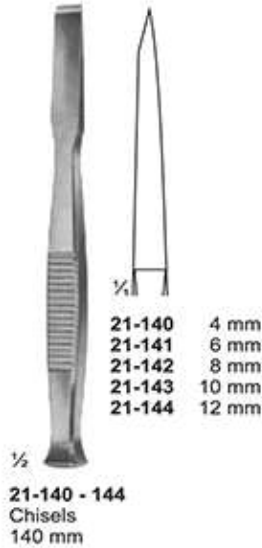
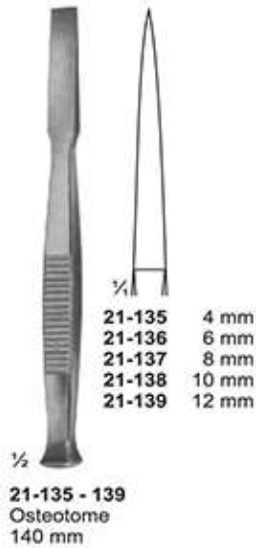
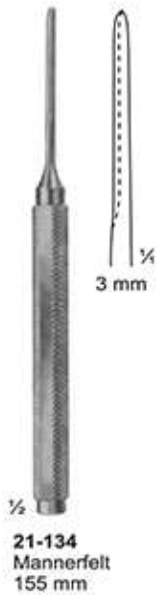

Tampers - osteotomes, Chisels and Gouges



21-118
Haase
100 mm



21-119 - 120
PASSOW
120 mm



21-121 - 123
CASPER
200 mm



21-124 - 126
200 mm

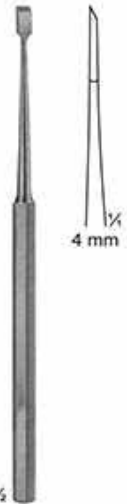

21-127
FREER
Chisel
160 mm

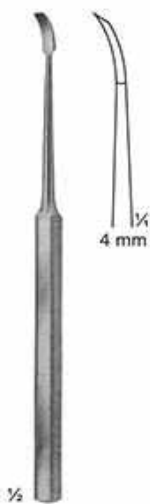

21-128
FREER
Chisel, curved
160 mm

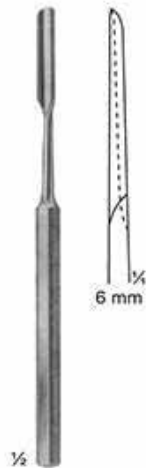

21-129
FREER
Gouge
150 mm

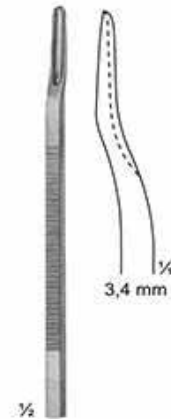

21-130
Scaphoid gouge,
downwards curved
135 mm



21-131
Scaphoid gouge,
upwards curved
135 mm



21-131A - 133
Mannerfelt
21-131A 4 mm
21-132 6 mm
21-133 8 mm
155 mm

Mallets



21-114
BERGMANN
245 mm



21-115
BERGMANN
235 mm



21-116
OMBREDANNE
240 mm



21-117
HEATH
copper filled head
700 g
185 mm

Mallets



Ø 27 mm

½

21-107
HAJEK
140 g
215 mm



Ø 30 mm

½

21-108
215 g
with interchangeable
plastic disks
245 mm
21-109
pair of spare disks



Ø 35 mm

21-111
1 metal disks, flat
1 metal disks, convex

21-112
1 plastic disks, flat
1 plastic disks, convex

21-113
Wrench

½

21-110 - 113
WAGNER
complete with:
1 pair of metal disks and
1 pair of plastic disks and
1 wrench 566
235 mm

Mallet without disks 130 g

Mallets



21-101
MEAD
185 g
with interchangeable
plastic disks
190 mm
21-102
pair of spare disks



21-103
140 g
with interchangeable
plastic disks
185 mm
21-104
pair of spare disks



21-105
COTTLE
140 g
1 Seite convex
1 Side convex
185 mm



21-106
165 g
lead filled head
190 mm

Bone Currettes

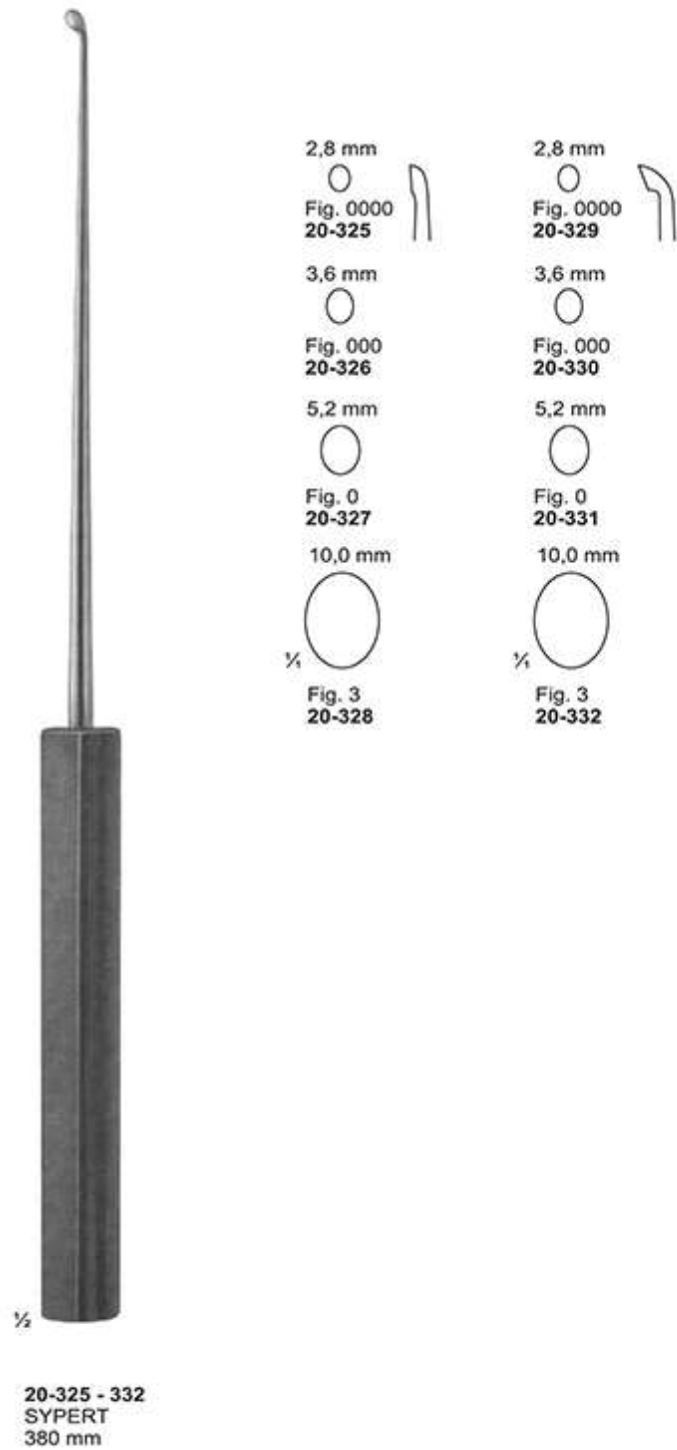
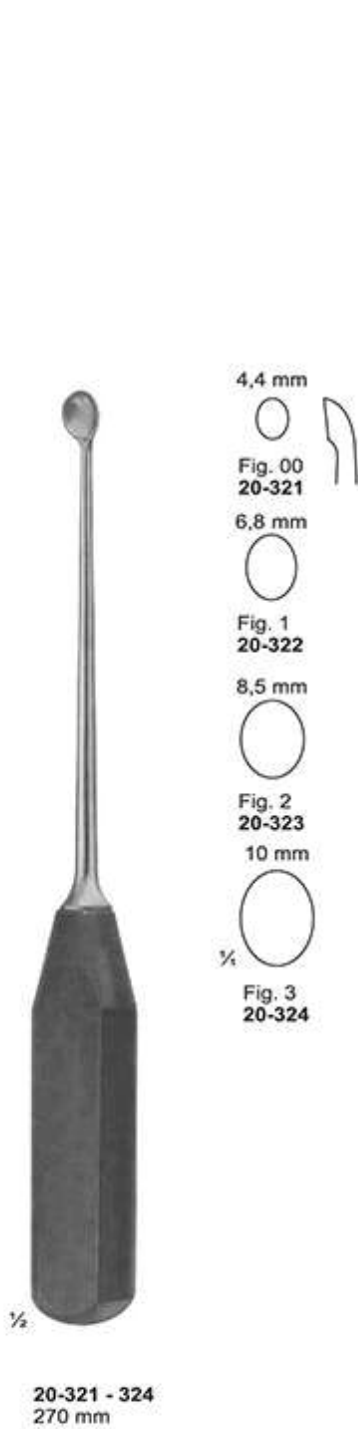

Bone Currettes

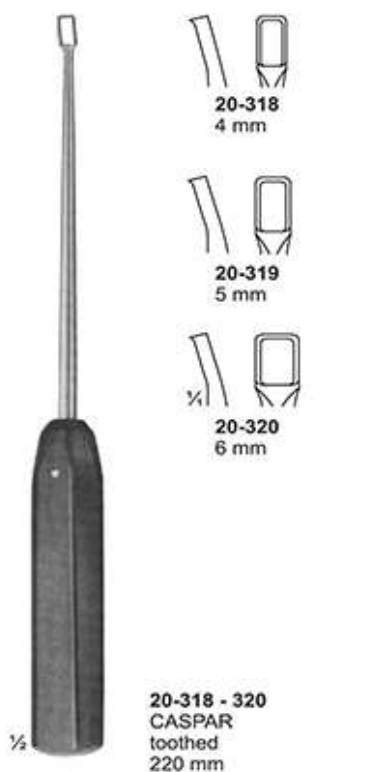
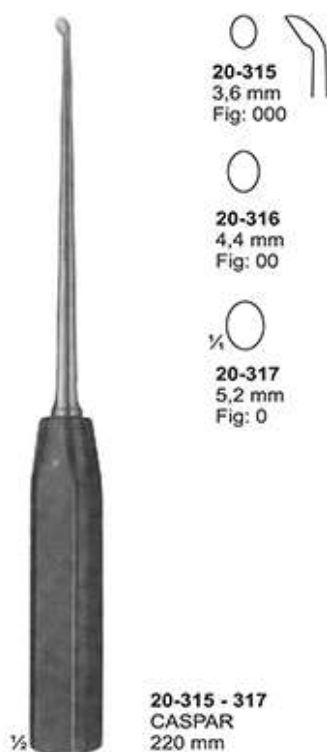
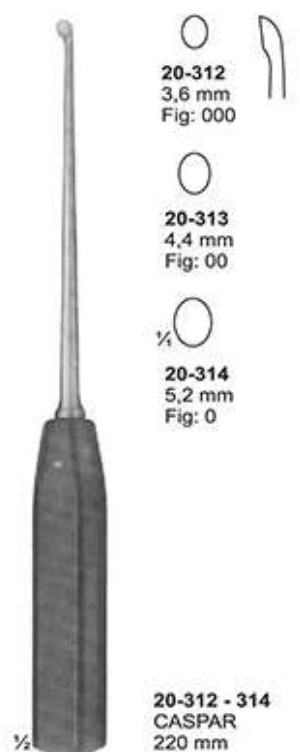
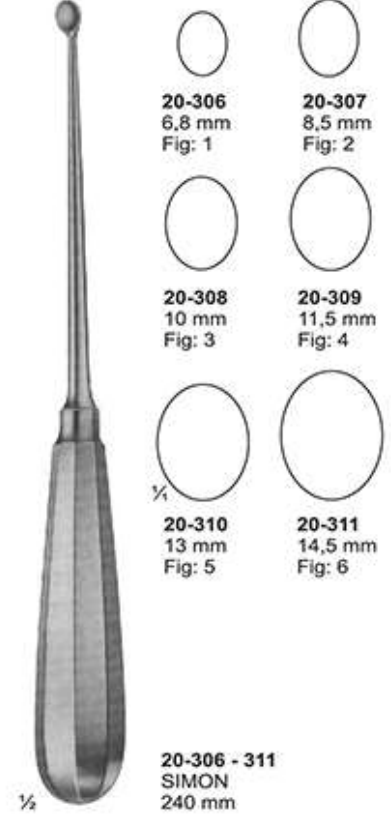

Bone Currettes

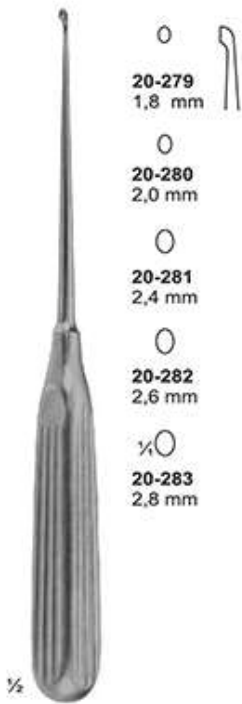

20-279
1,8 mm

20-280
2,0 mm

20-281
2,4 mm

20-282
2,6 mm

20-283
2,8 mm

1/2

20-279 - 283
LEMPERT
215 mm

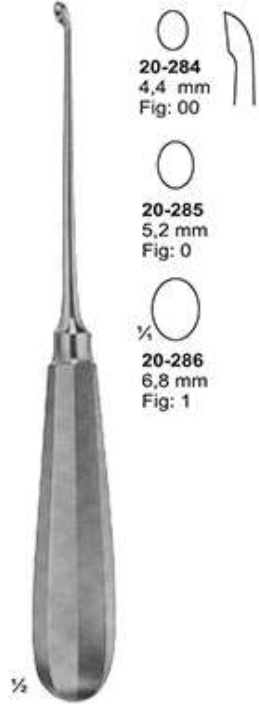

20-284
4,4 mm
Fig: 00

20-285
5,2 mm
Fig: 0

20-286
6,8 mm
Fig: 1

1/2

20-284 - 286
HALLE
215 mm

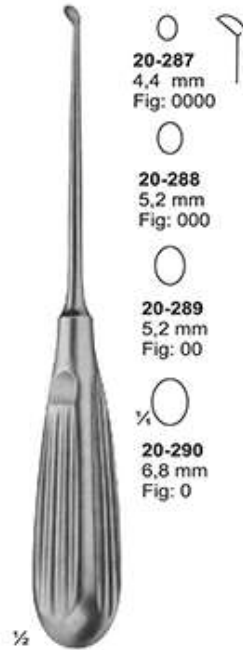

20-287
4,4 mm
Fig: 0000

20-288
5,2 mm
Fig: 000

20-289
5,2 mm
Fig: 00

20-290
6,8 mm
Fig: 0

1/2

20-287 - 290
DAUBENSPECK
200 mm



20-291
3,6 mm
Fig: 000

20-292
4,4 mm
Fig: 00

20-293
5,2 mm
Fig: 0

20-294
6,8 mm
Fig: 1

1/2

20-291 - 294
250 mm



20-295
3,6 mm
Fig: 000

20-296
4,4 mm
Fig: 00

20-297
5,2 mm
Fig: 0

20-298
6,8 mm
Fig: 1

1/2

20-295 - 298
250 mm



20-299
3 mm

20-300
4 mm

20-301
5 mm

1/2

20-299 - 301
BUSHE
250 mm

Bone Currettes

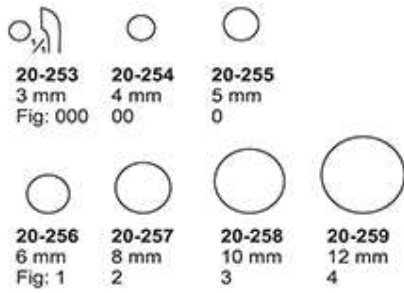

20-253 - 259
BRUNS
165 mm

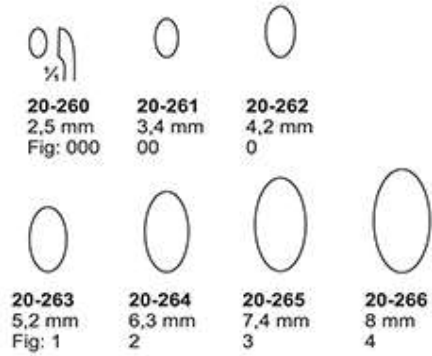

20-260 - 266
SCHEDE
170 mm

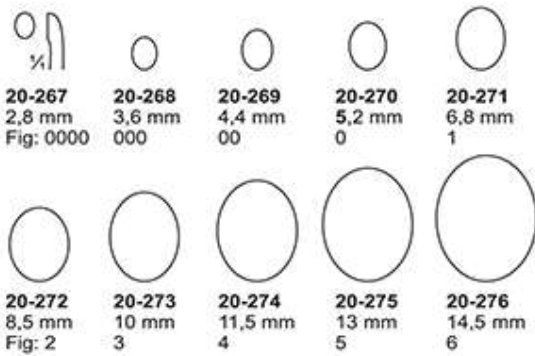

20-267 - 276
VOLKMANN
170 mm

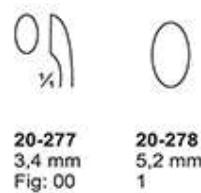

20-277 - 278
WILLIGER
170 mm

Bone Currettes



20-242
JANSEN
160 mm



20-243
HEMINGWAY
170 mm



20-244
HEMINGWAY
175 mm



20-245
LUCAS
180 mm

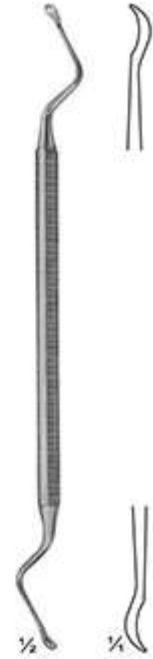

20-246
LUCAS
185 mm

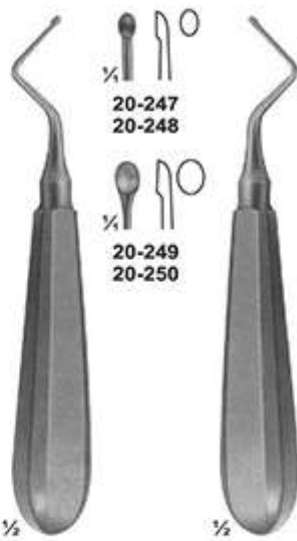

20-247 - 248
KERPEL
145 mm



20-249 - 250
KERPEL
145 mm



20-251
UFFENDORDE
170 mm



20-252
UFFENDORDE
170 mm

Bone Currettes

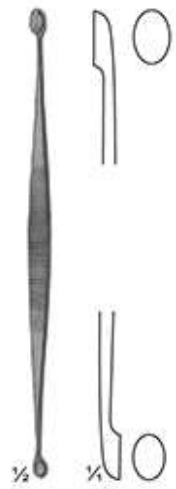

20-233
JACOBSON
140 mm

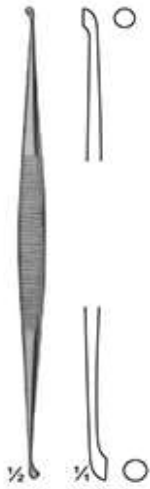

20-234
MARTINI
140 mm



20-235
MARTINI
140 mm



20-236
WILLIGER
145 mm



20-237
JANSEN
160 mm



20-238
BARTH
180 mm



20-239
VOLKMANN
130 mm

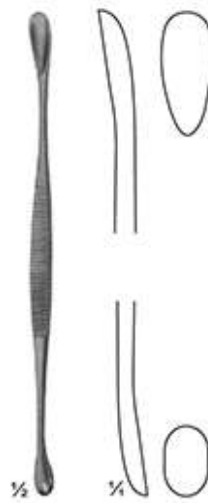

20-240
VOLKMANN
145 mm

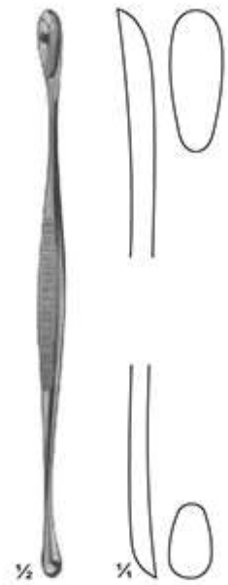

20-241
VOLKMANN
170 mm

Bone File and Rasps

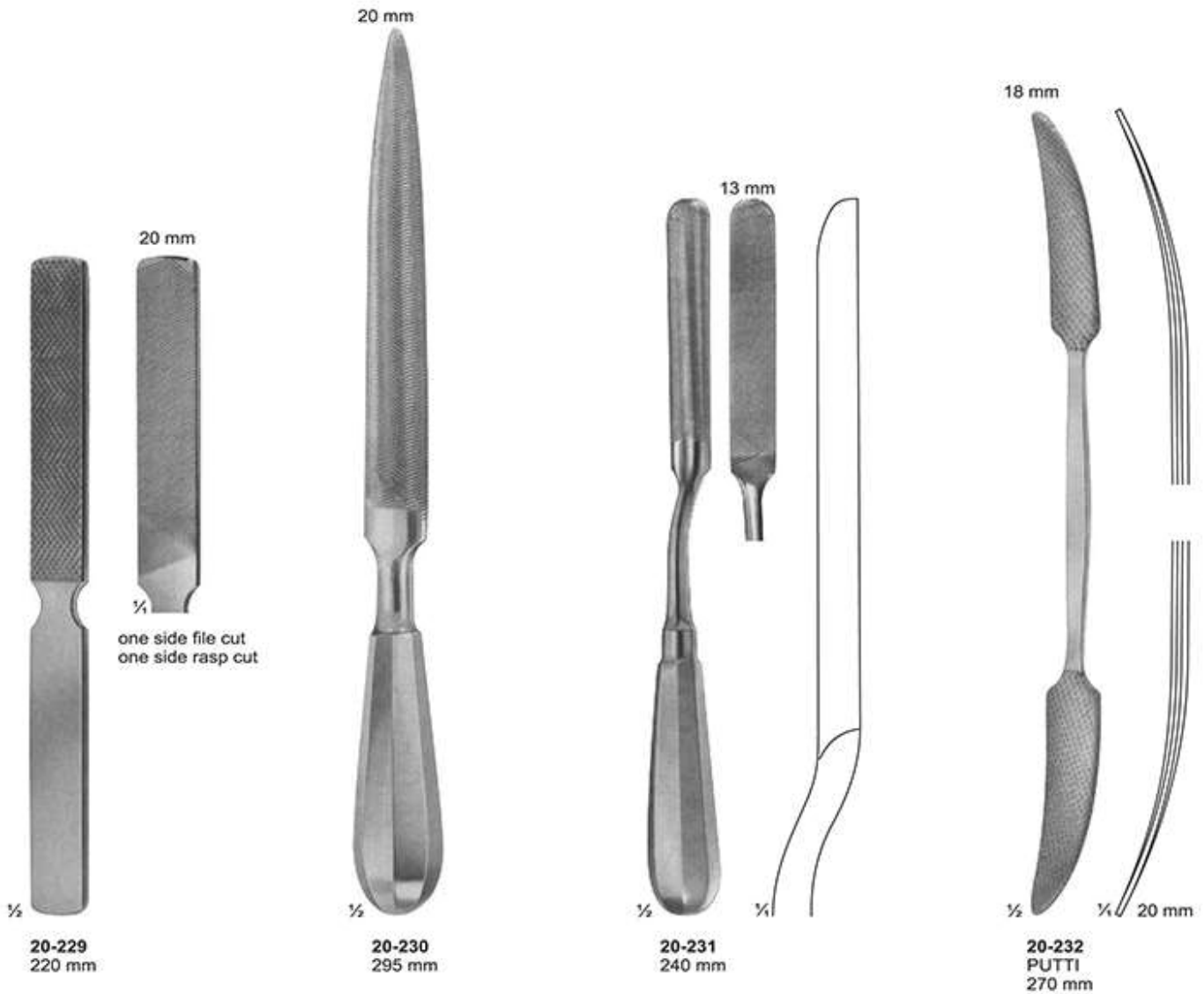

Bone File and Rasps

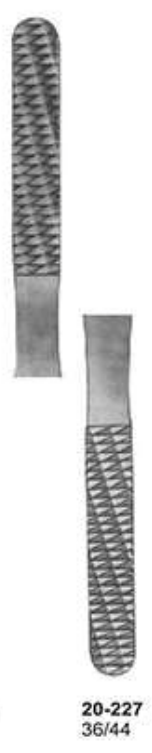
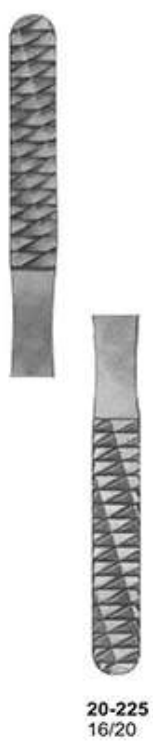
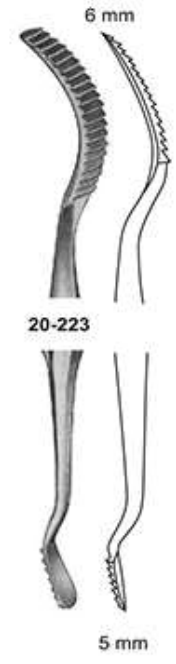
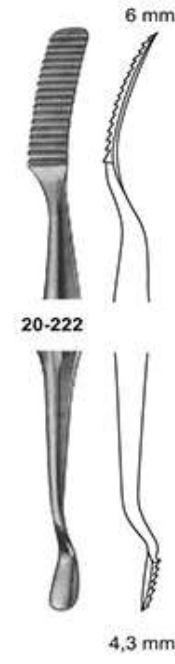
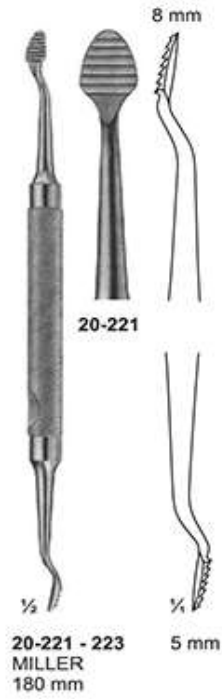

Bone File and Rasps

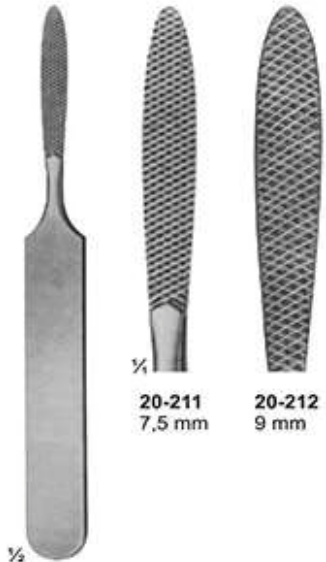

20-211
7,5 mm

20-212
9 mm

20-211
JOSEPH
fine, chequered

20-212
coarse, chequered
165 mm

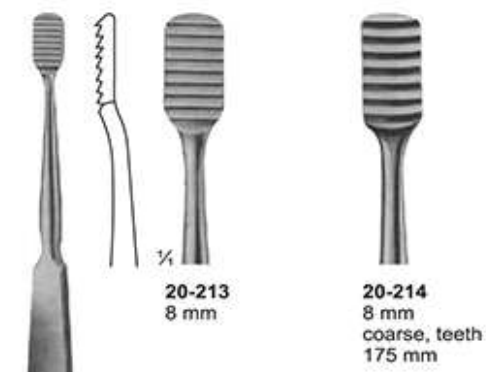

20-213
8 mm

20-214
8 mm
coarse, teeth
175 mm

20-213
LEWIS
fine, teeth



20-215
MALTZ
down stroke
180 mm

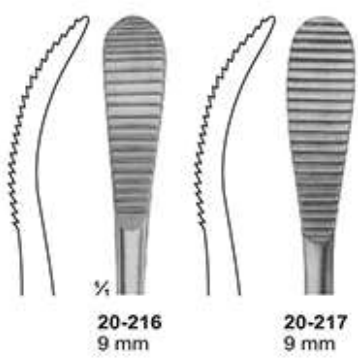

20-216
9 mm

20-217
9 mm



20-216
AUFRICHT
up stroke
20-217
down stroke
220 mm



20-218
GALLAHER
190 mm

Raspatories with HARTPRESS-handle

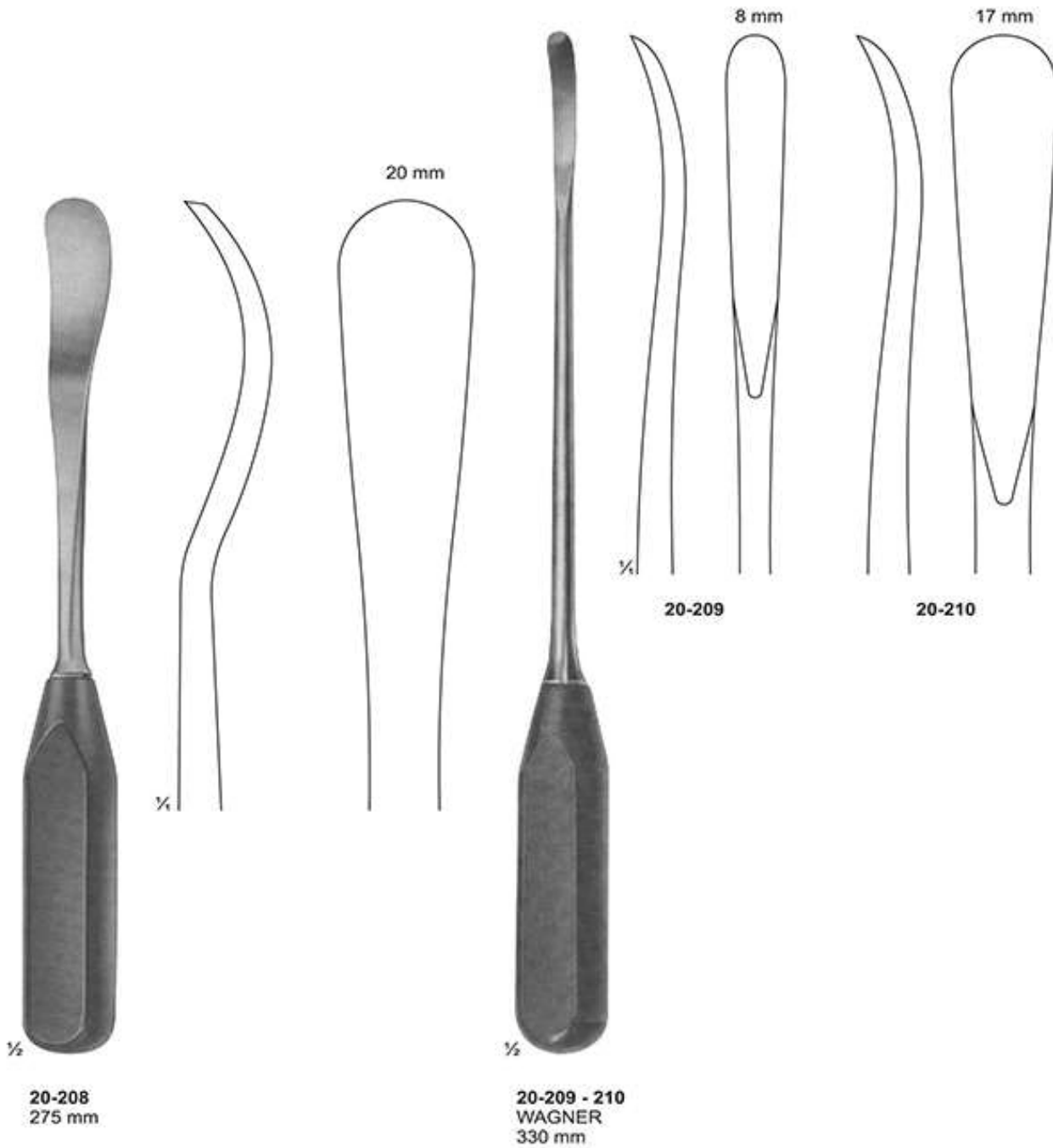

Raspatories

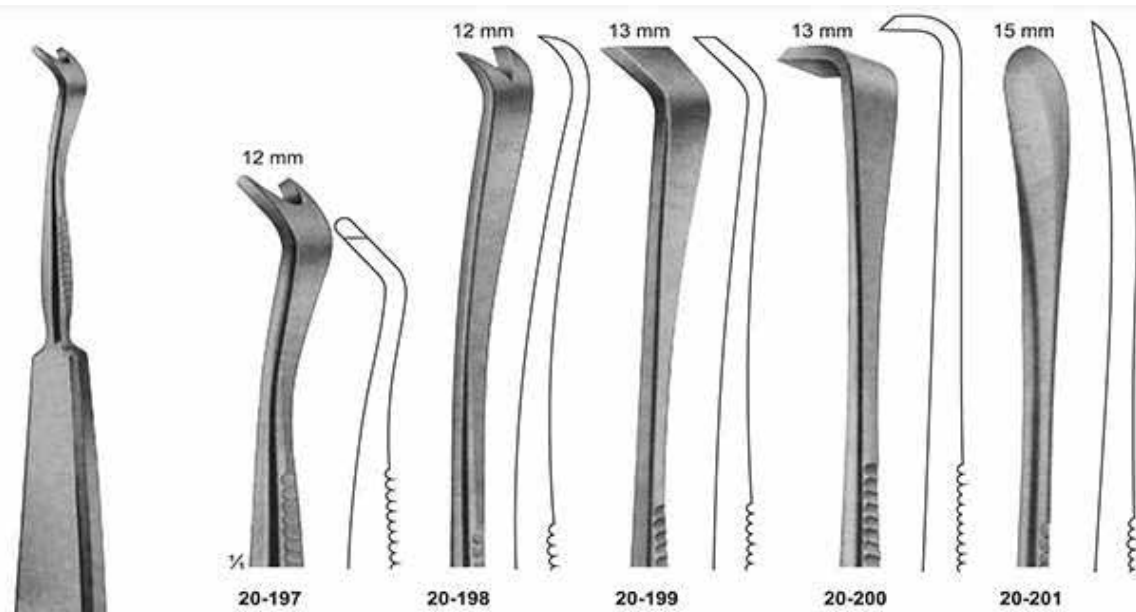

20-197 - 201
SEMB
230 mm



20-206

20-207



20-202

20-203

20-204

20-205

20-202 - 203
DOYEN
for children
20-204 - 205
for adults

20-206 - 207
DOYEN
240 mm

Raspatories

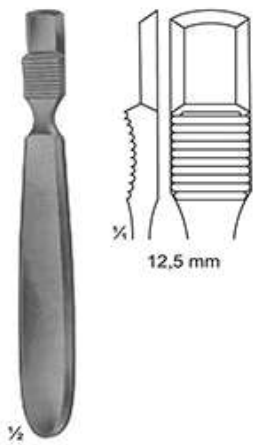

20-191
FARABEU
140 mm



20-192
FARABEU
140 mm

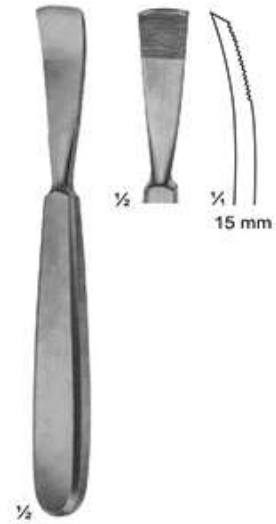

20-193
JANSEN
165 mm

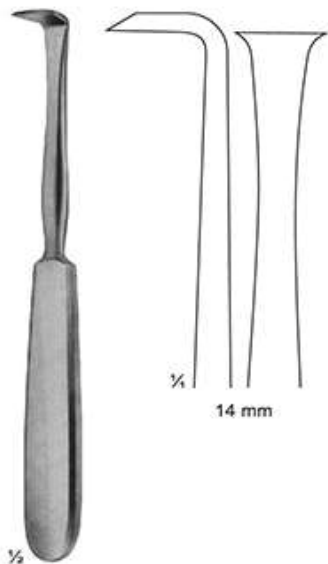

20-194
LANGENBACK
180 mm

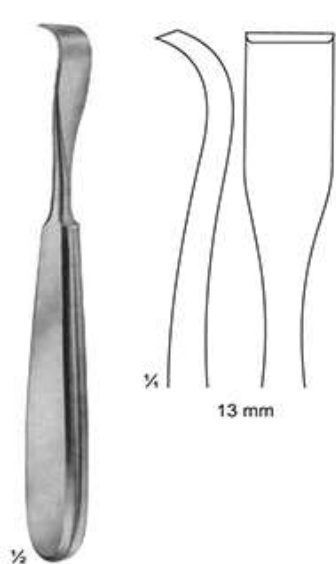

20-195
SCHNEIDER
175 mm

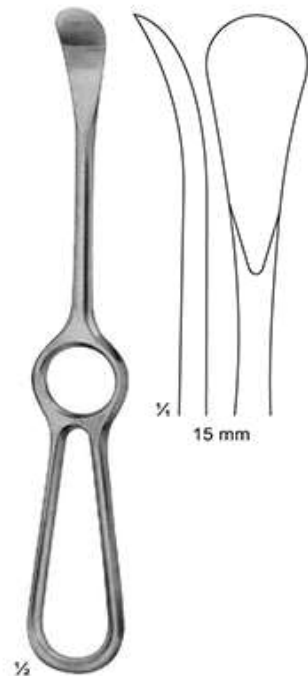

20-196
SEDILLOT
215 mm

Raspatories

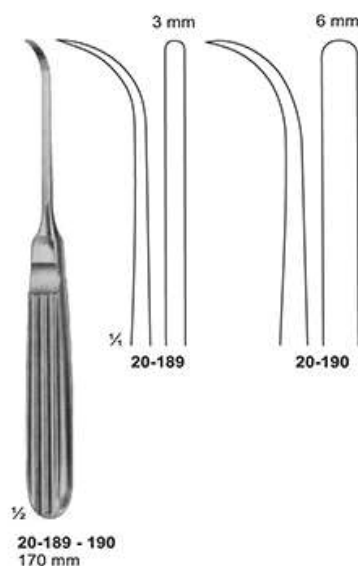
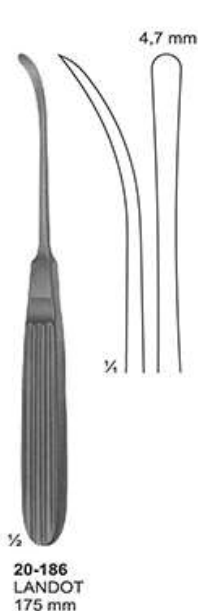
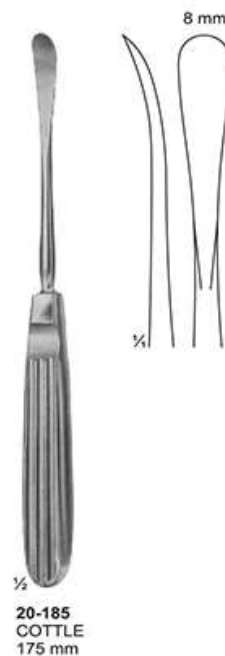
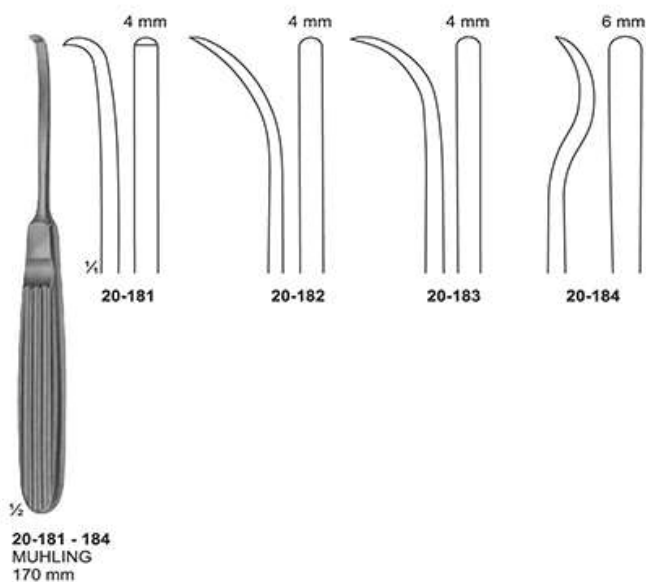

Raspatories

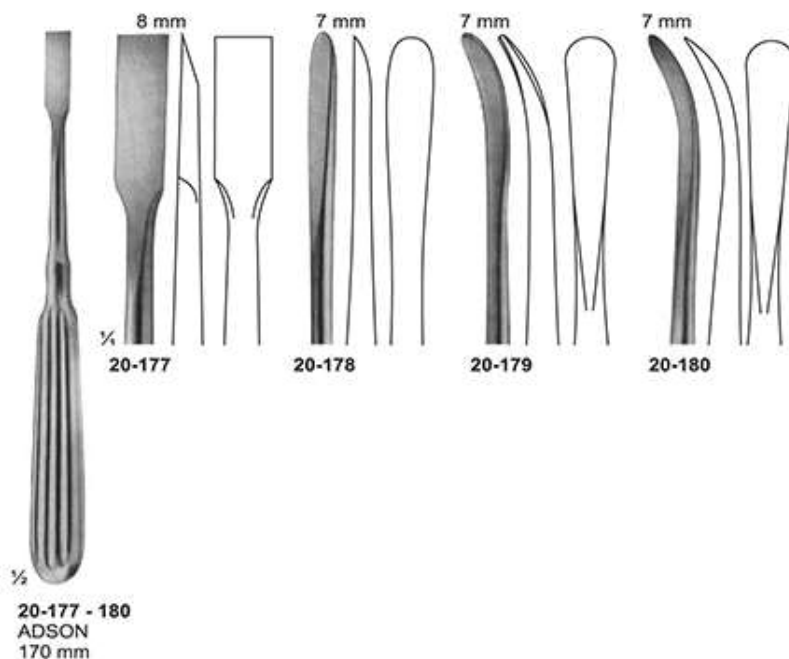
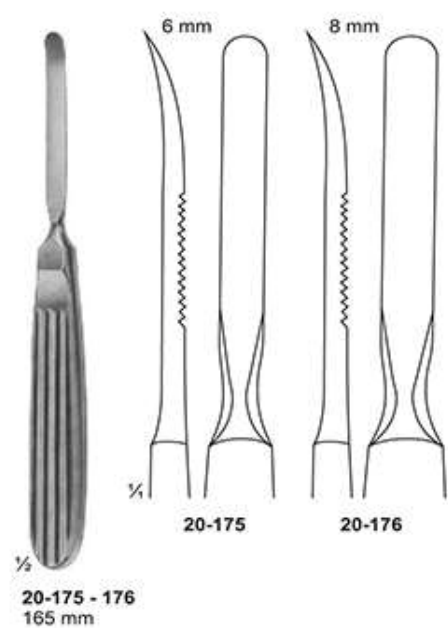
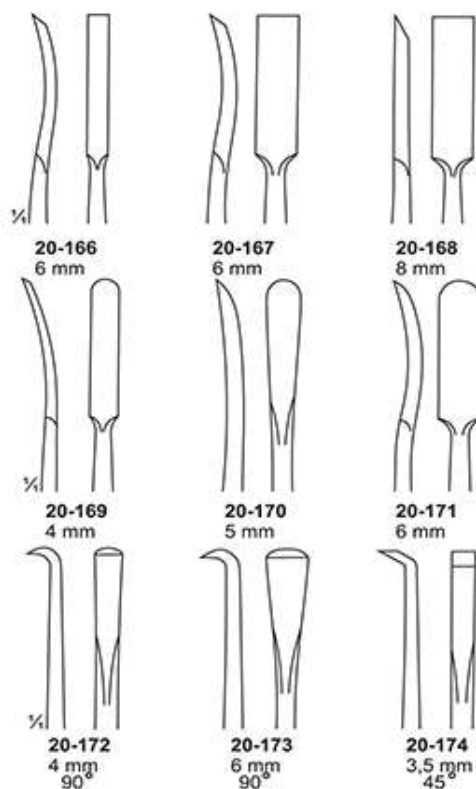
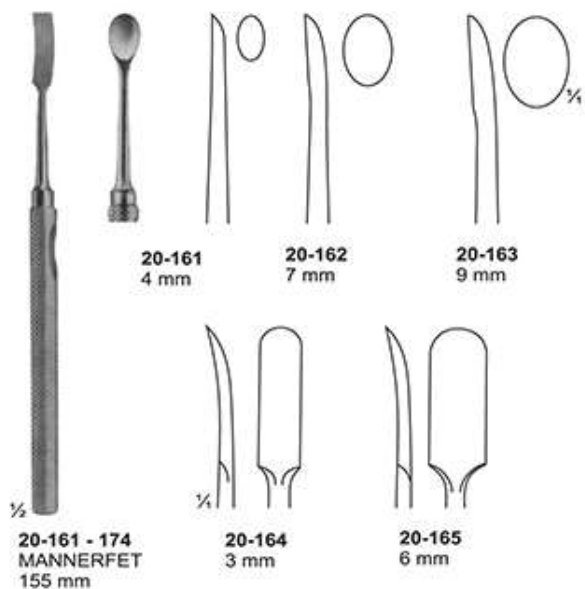

Raspatories



20-152
KILLIAN
sharp/blunt
185 mm

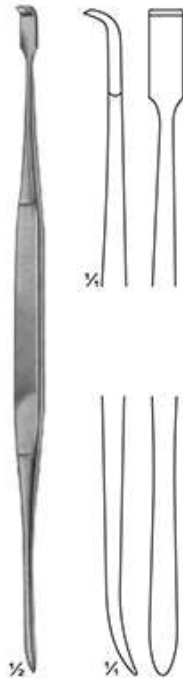

20-153
HOWARTH
sharp/blunt
215 mm

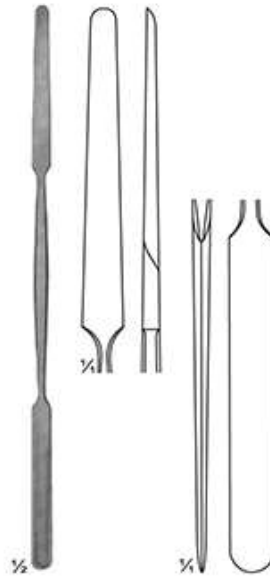

20-154
KILLIAN
sharp/blunt
185 mm

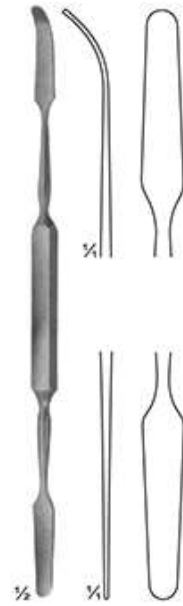

20-155
MAC DONALD
blunt/blunt
185 mm

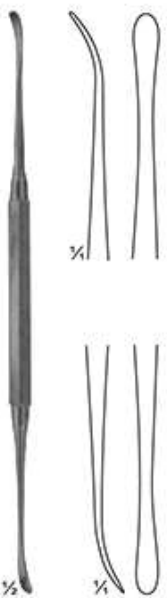

20-156
FREER
sharp/blunt
185 mm

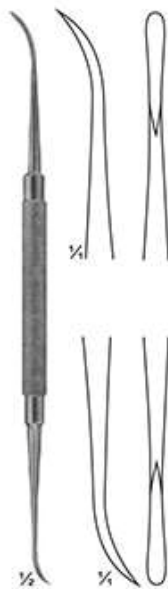

20-157
FREER-YASARGIL
sharp/sharp
185 mm

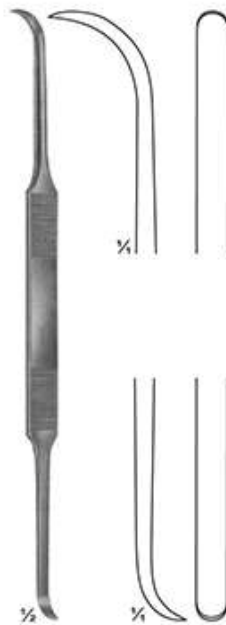

20-158
COTTLE
sharp/sharp
200 mm



20-159
MEAD
sharp/sharp
165 mm

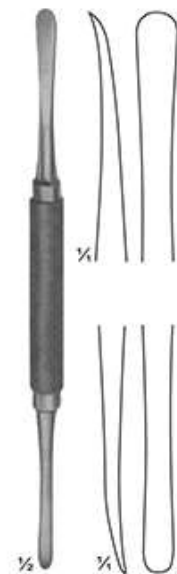

20-160
MOLT
sharp/sharp
180 mm

Raspatories

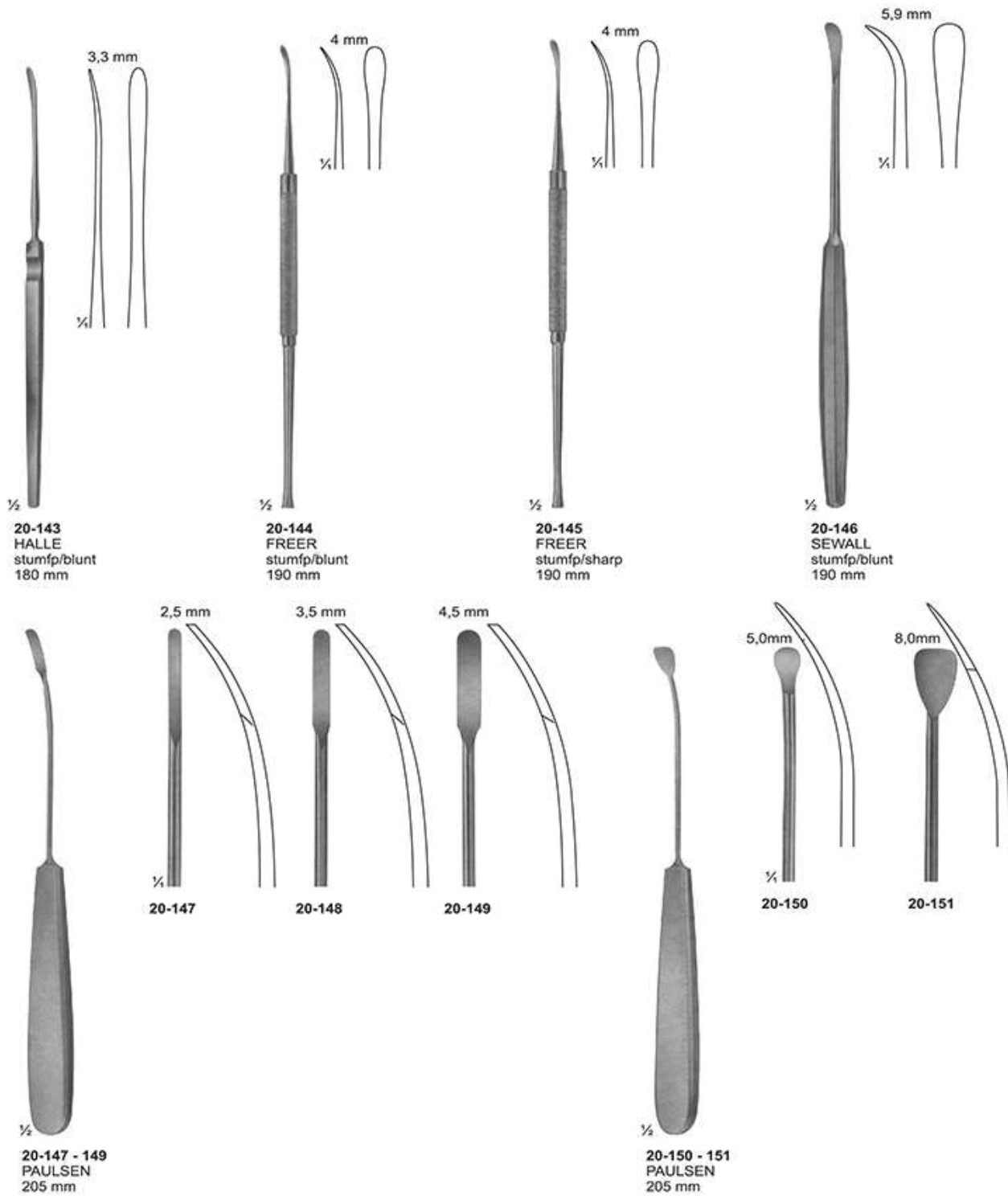

Raspatories



20-134 - 135
PARTSCH
150 mm

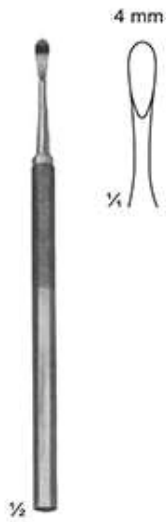

20-136
PARTSCH mod. LANGE
145 mm



20-137
MC KENTY
155 mm

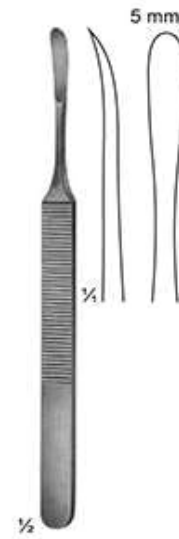

20-138
KONIG
155 mm

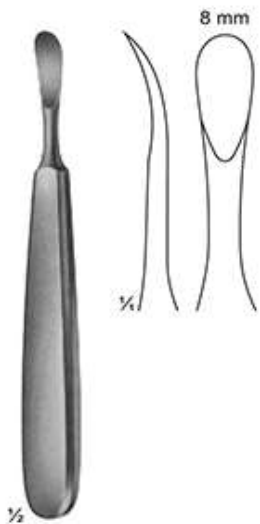

20-139
TRELAT
150 mm

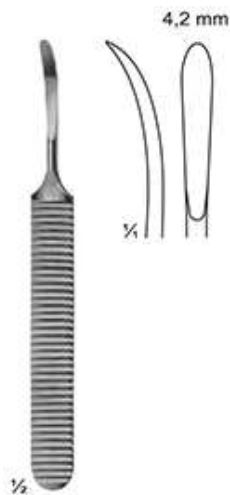

20-140
WILLIGER
140 mm



20-141
WILLIGER
160 mm

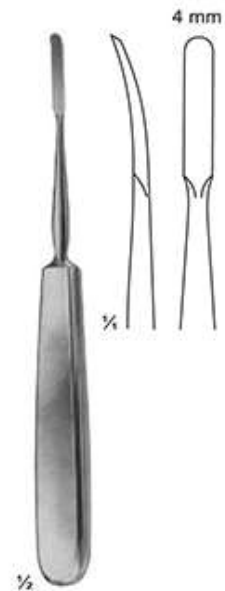

20-142
JOSEPH
170 mm

Special Bone Levers

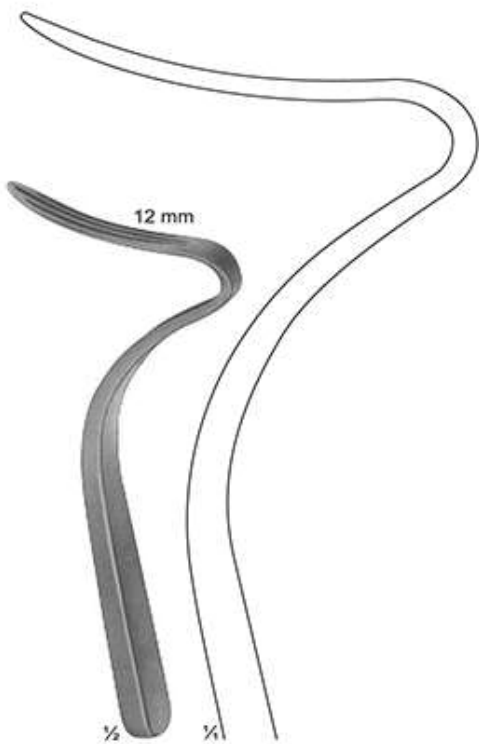

20-131
TAGER
Bone lever for
angle joint operations

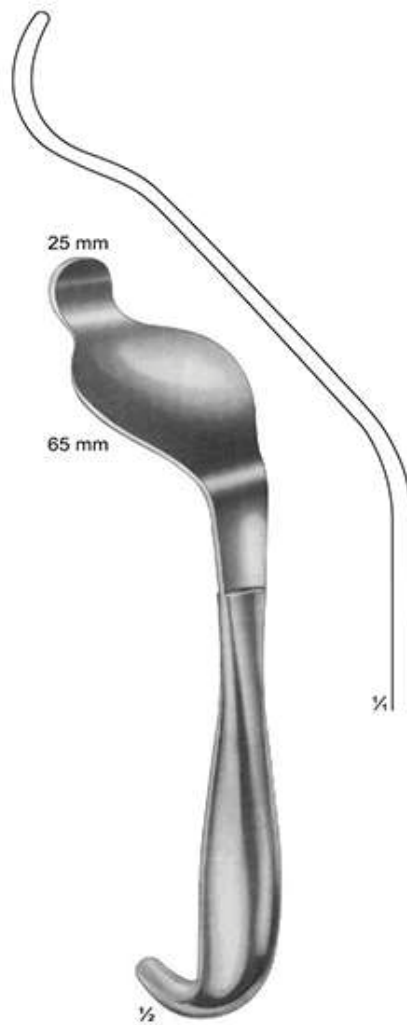

20-132
BENNETT
235 mm

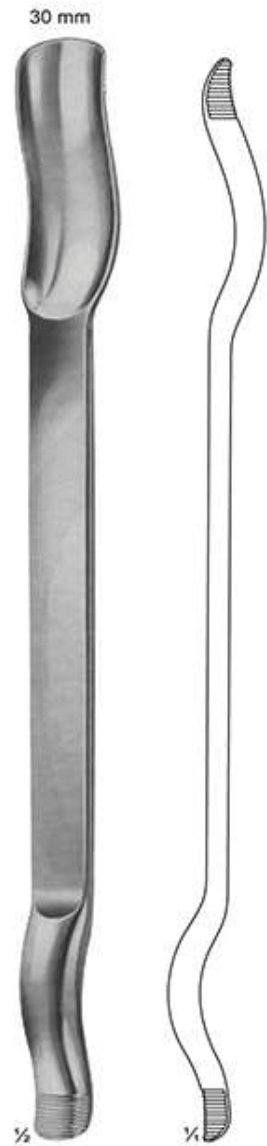

20-133
MURPHY-LANE
Luxation lever
340 mm

Bone Levers

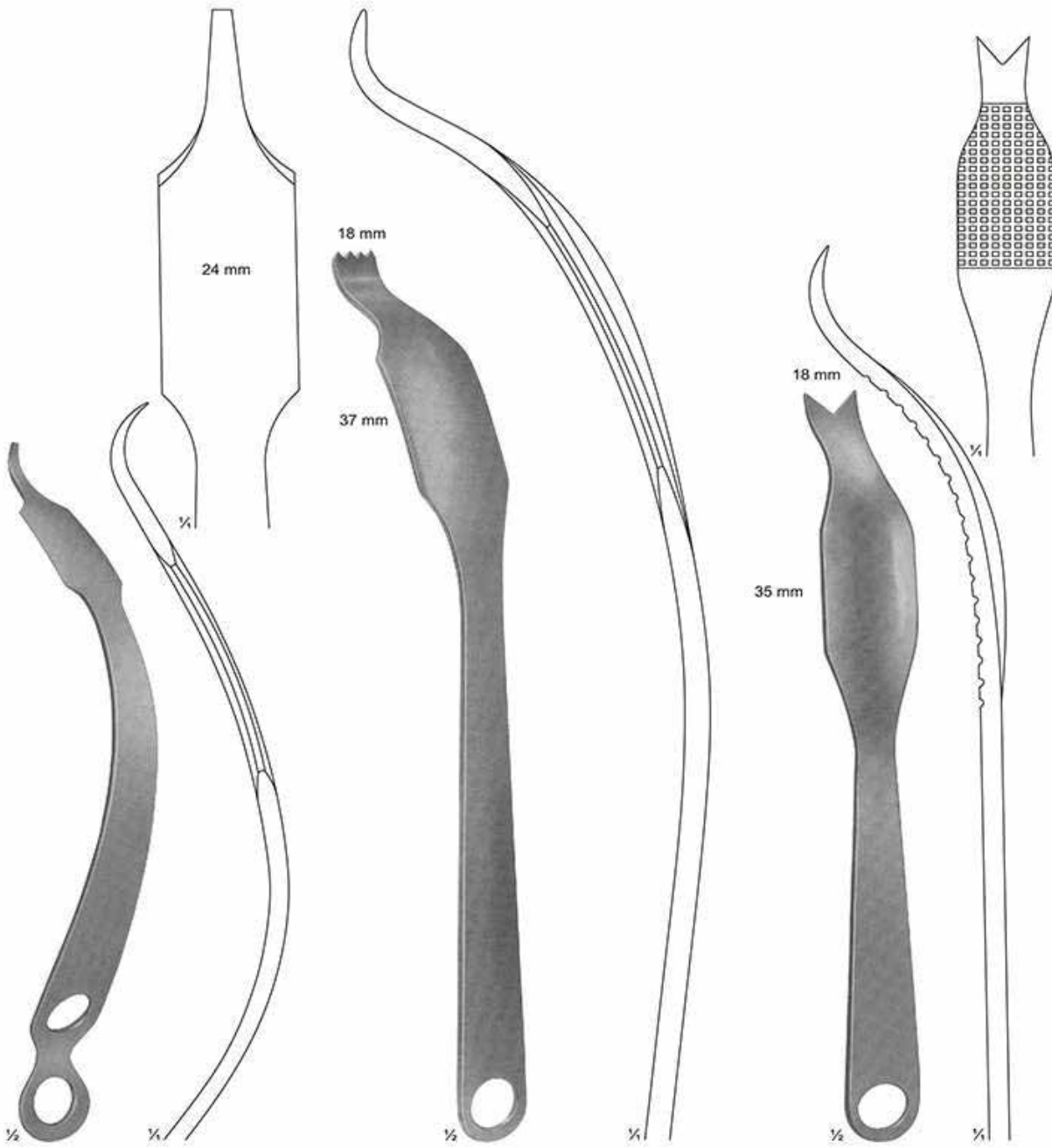

20-128
HOHMANN-ALDINGER
270 mm

20-129
SCHUMACHER mod. WAGNER
345 mm

20-130
SCHUMACHER
290 mm

Bone Levers

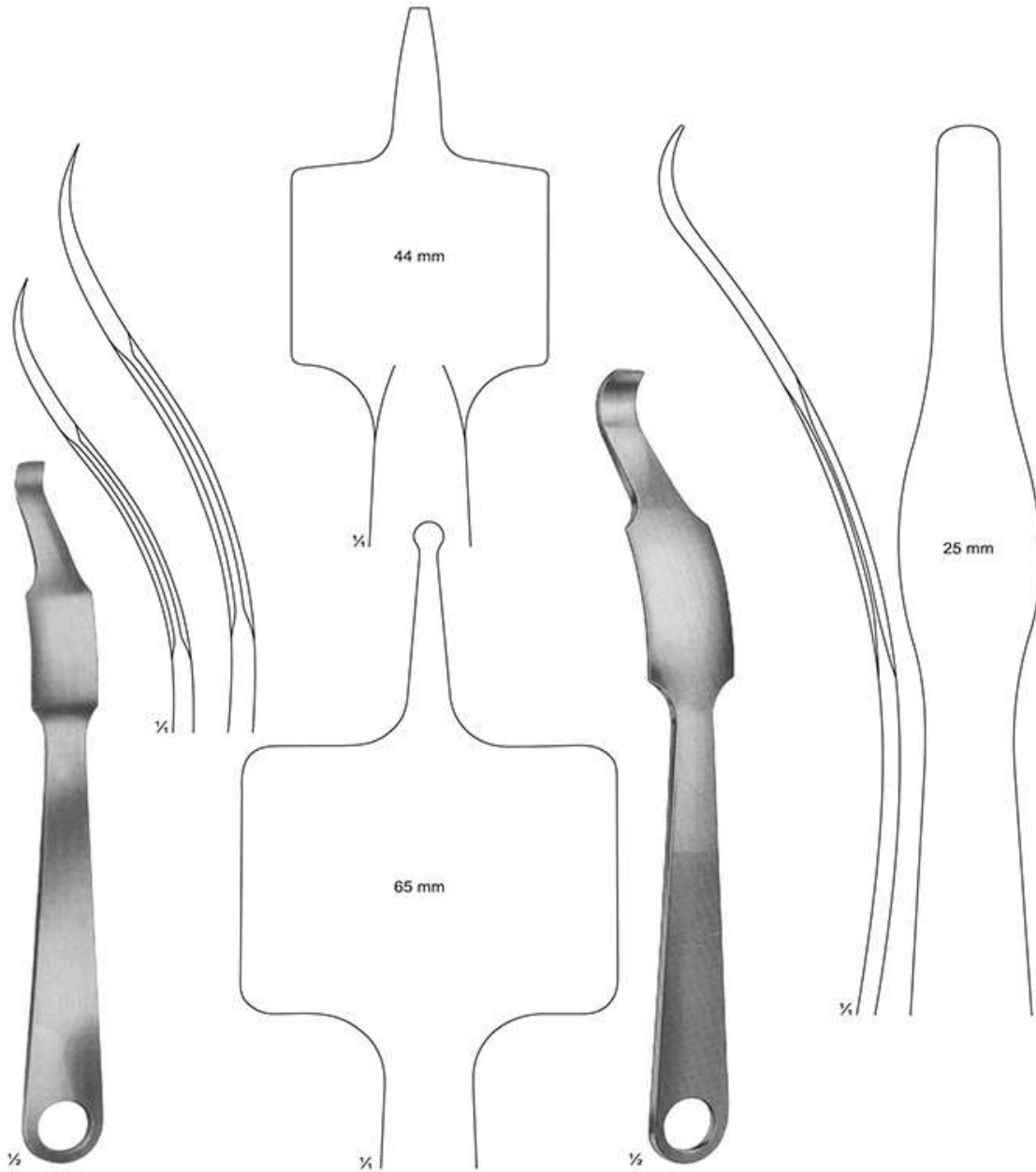

20-125 - 126
VERBRUGGE-MULLER
20-125 240 mm
20-126 255 mm

20-127
260 mm

Bone Levers

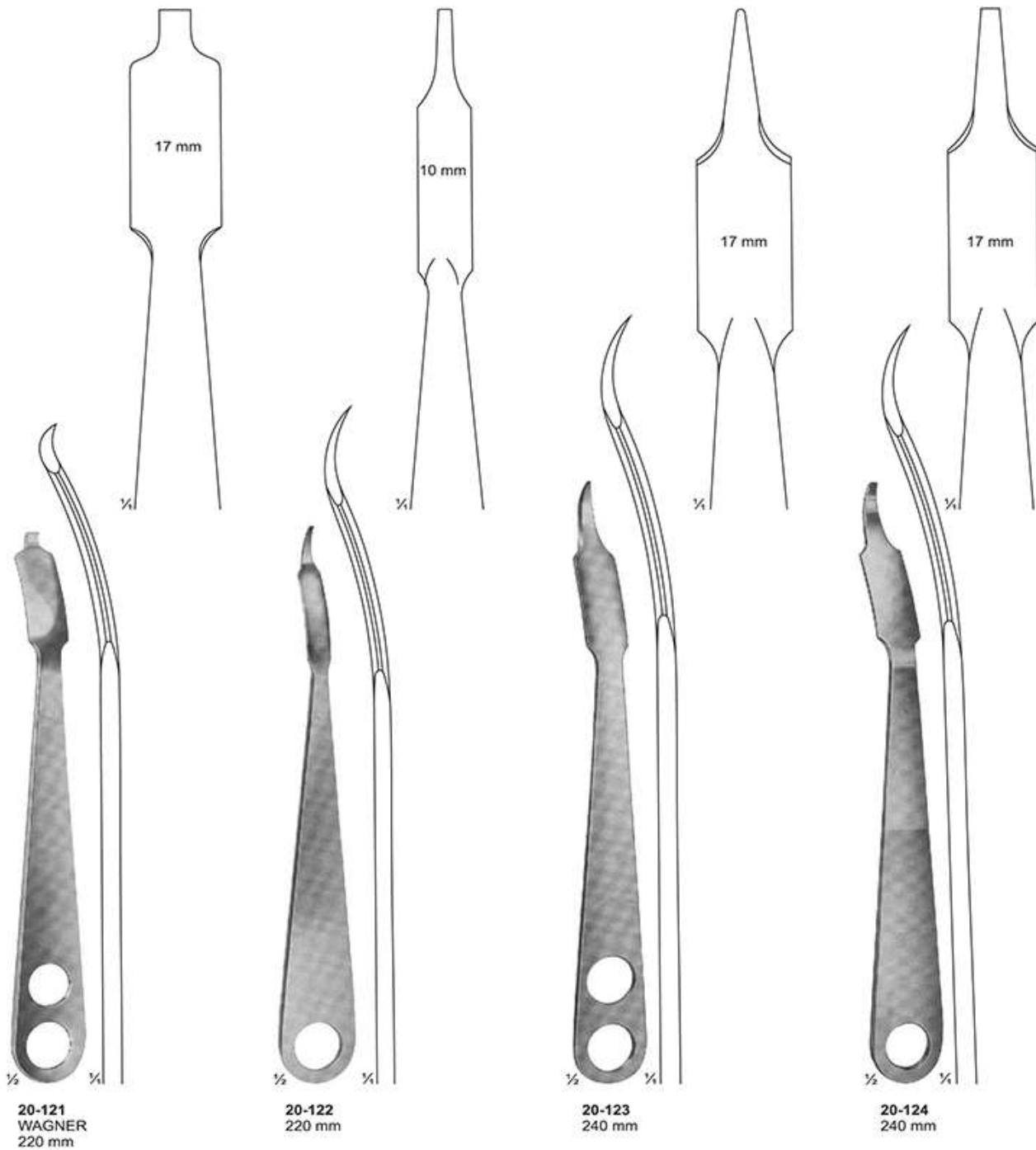

Bone Levers

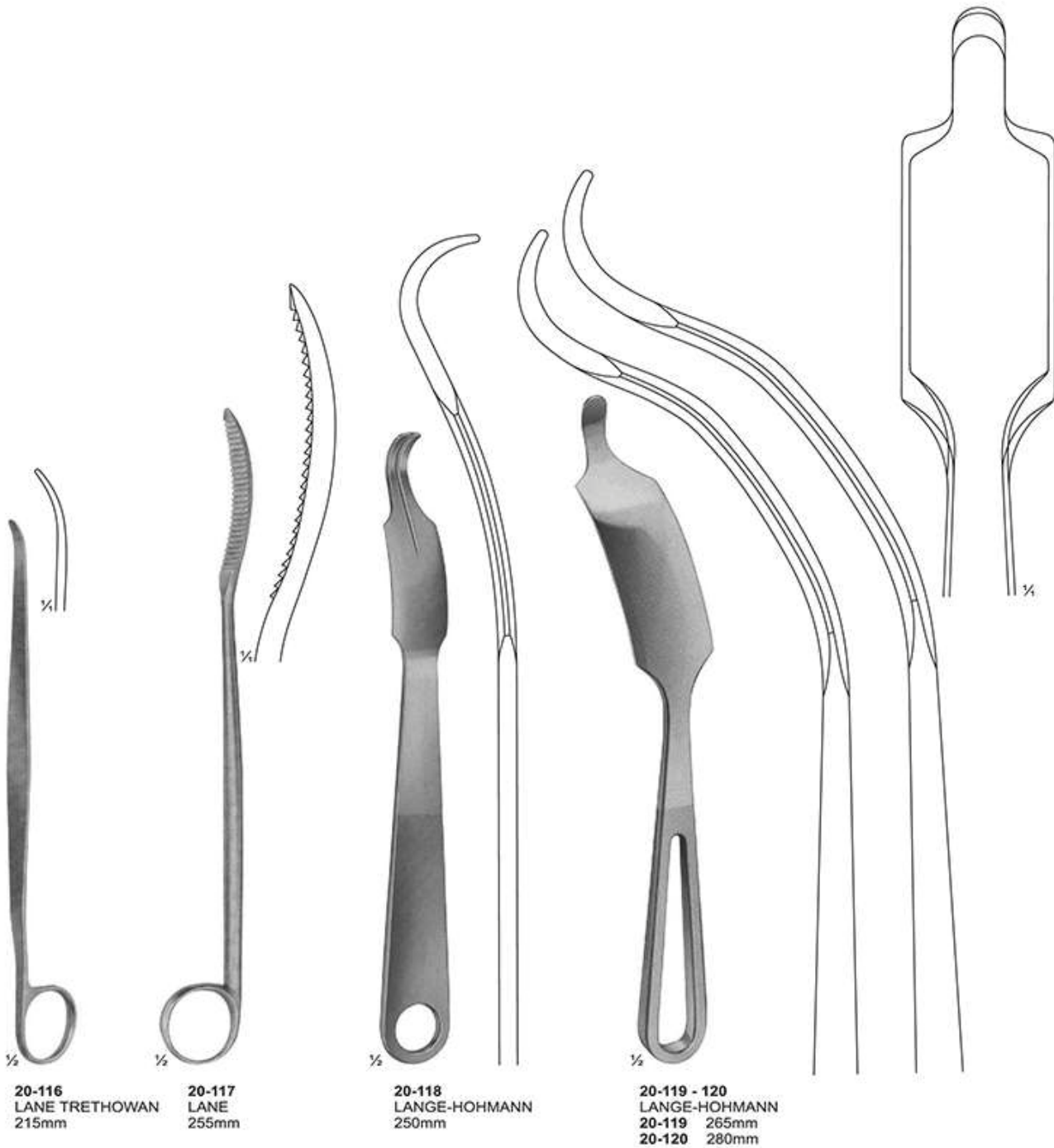

20-116
LANE TRETOWAN
215mm

20-117
LANE
255mm

20-118
LANGE-HOHMANN
250mm

20-119 - 120
LANGE-HOHMANN
20-119 265mm
20-120 280mm

Bone Levers

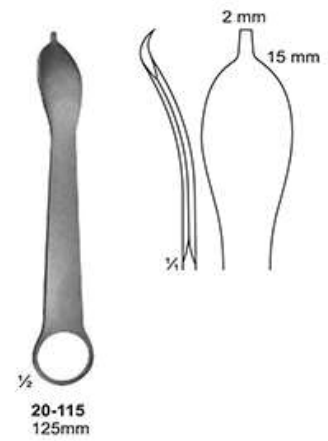
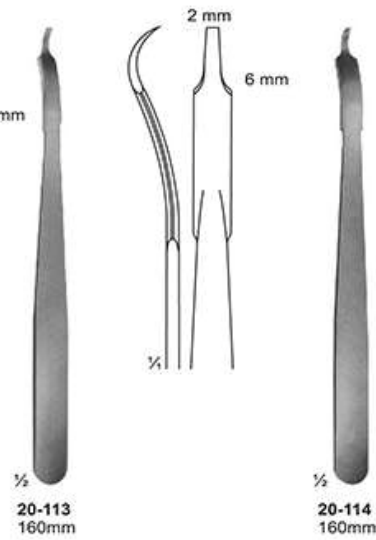
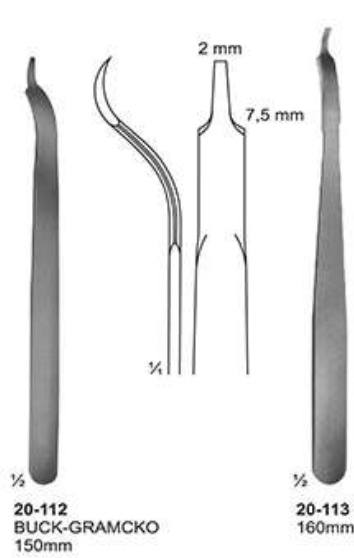
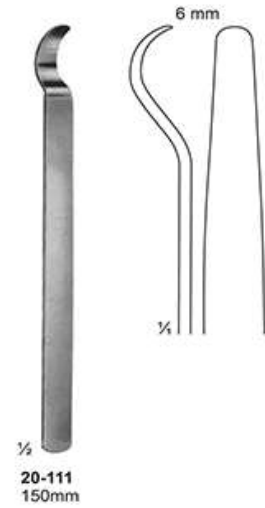
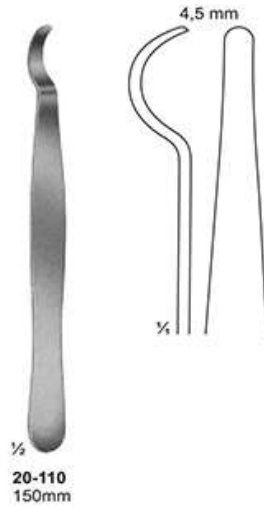
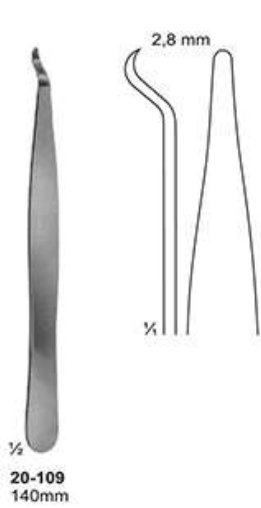

Elevators and Bone Levers

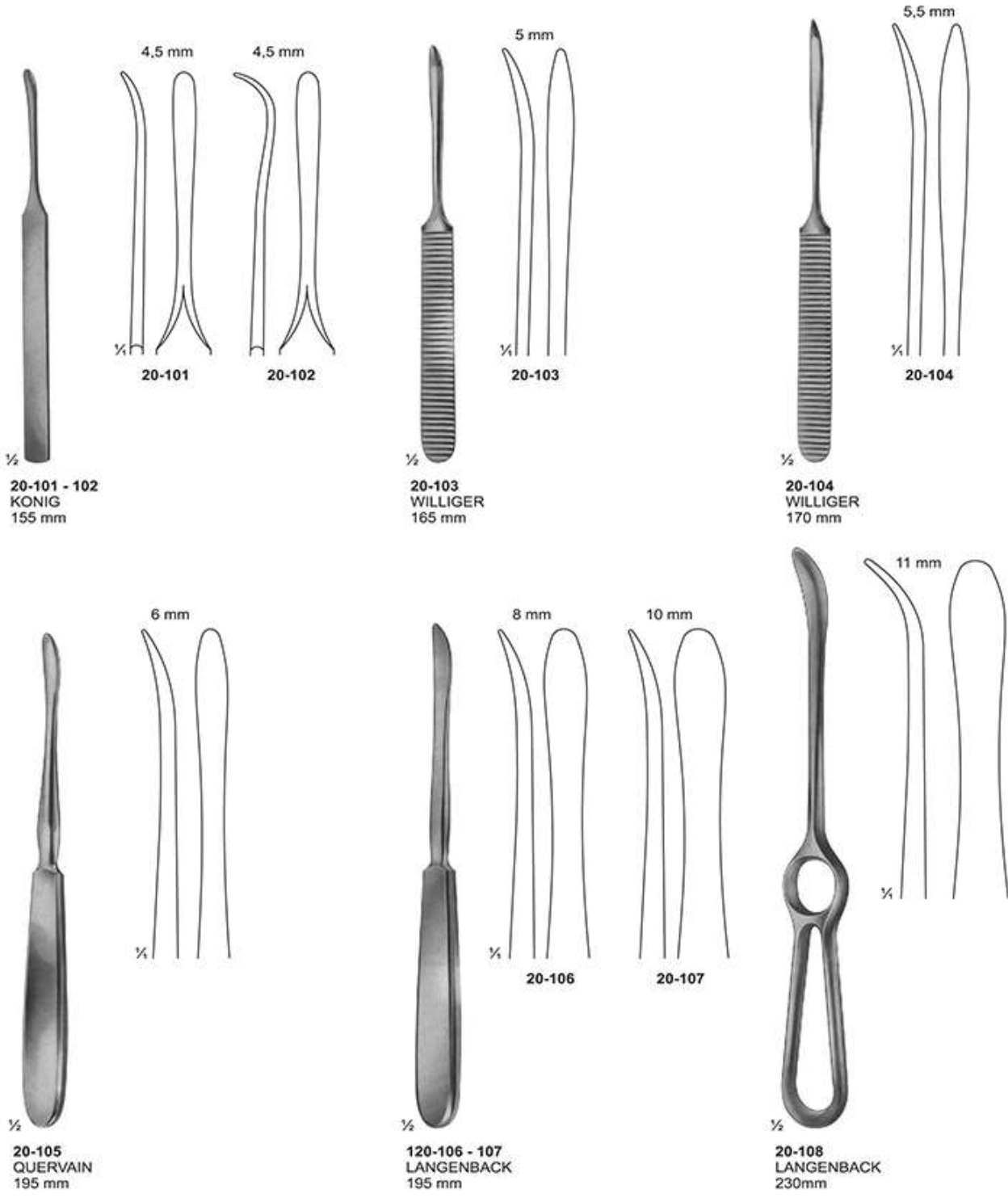

Wire Saws and Conductor



OLIVECRONA
19-134 300 mm
19-135 400 mm
19-136 500 mm
19-137 700 mm

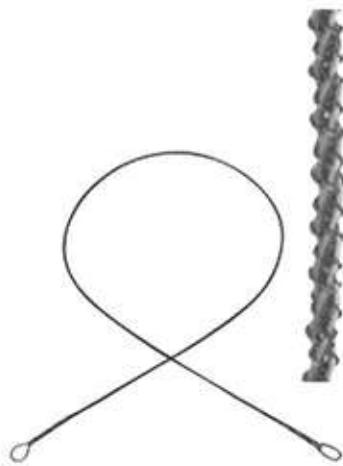

GIGLI
19-138 300 mm
19-139 400 mm
19-140 500 mm
fine, 6 wires twisted
19-141
coarses, 4 wires twisted



19-142
GIGLI
Handle



19-143
LEBSCHE
Conductor for
wire saws, malleable
250 mm

Amputation Saws

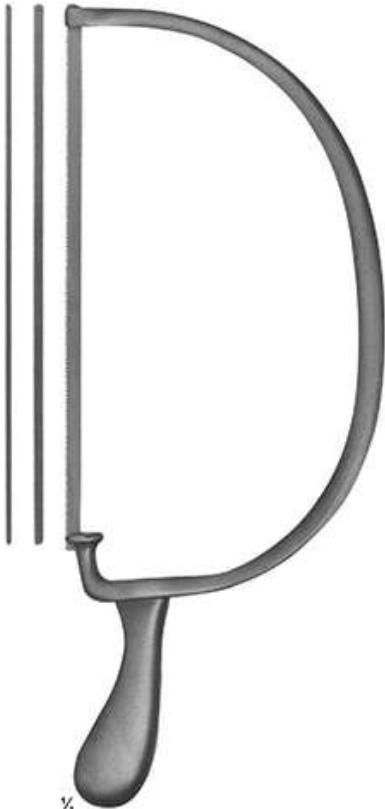

1/2
19-126
BIER
 Length of blade
 270 mm
 complete with one saw
 blade each
 420 mm
 Spare saw blades, carbon steel
19-127 4 mm
19-128 6 mm
19-129 8 mm



1/2
19-130
CHARRIERE
 Length of blade
 180 mm
 Spare saw blades,
 carbon steel
 270 mm

19-131
CHARRIERE
 Length of blade
 240 mm
 Spare saw blades,
 carbon steel
 340 mm



1/2
19-132
SATTERLEE
 Length of blade
 200 mm
 Spare saw blades,
 carbon steel
 290 mm



1/2
19-133
LANGENBACK
 Length of blade
 115 mm
 Metacarpal saw
 235 mm

Amputation Saws



1/2
19-117
CHARRIEER
Length of blade
215 mm
complete with one saw
blade each
350 mm
Spare saw blades, carbon steel
19-118 12 mm
19-119 20 mm



1/2
19-120
RUST
Length of blade
235 mm
complete with one saw
blade each
390 mm
19-121 Bow only
Spare saw blades, carbon steel
19-122 6 mm
19-123 8 mm
19-124 12 mm
19-125 20 mm

Amputation Retractors

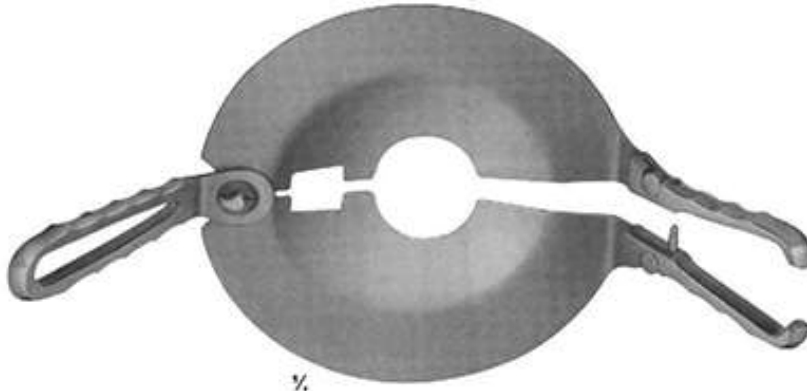

1/2

19-115
PERCY
removeable handles

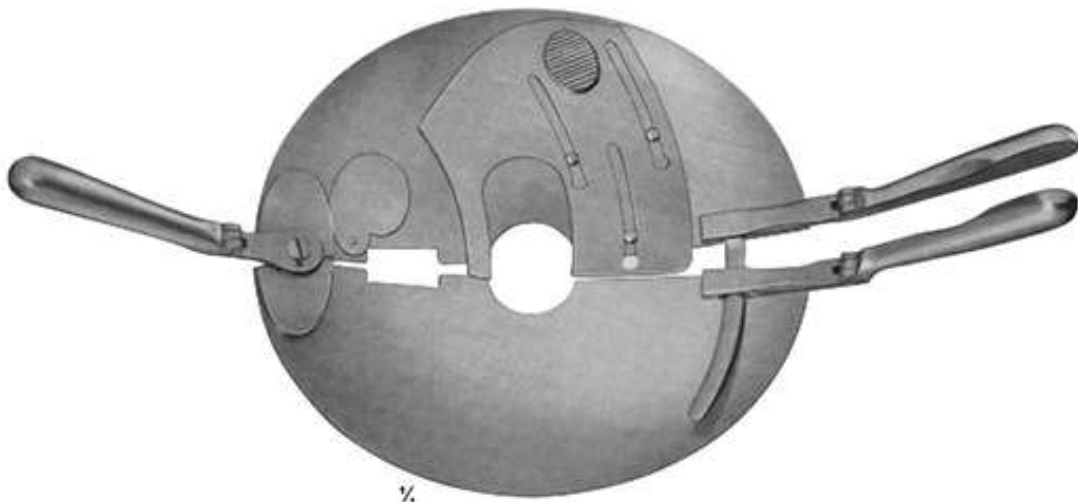

1/2

19-116
PERCY
reversible handles

Amputations and Resection Knives



19-110
Length of blades
Phalangeal knife
105 mm



19-111
Length of blades
Interosseous knife
110 mm



19-112
Length of blades
Periosteum knife
with raspatory
65 mm



19-113 - 114
LANGENBECK
Length of blades
Resection knives
55 mm



19-113



19-114

Amputation



19-101
Comprimeter. Compression apparatus for producing exsanguination in the extremities. Manometer registers up to 600 mm Hg. Complete, consisting of :
19-101 2 Pump with manometer
19-102 3 Cuff for the leg
19-103 14 Cuff for the upper arm

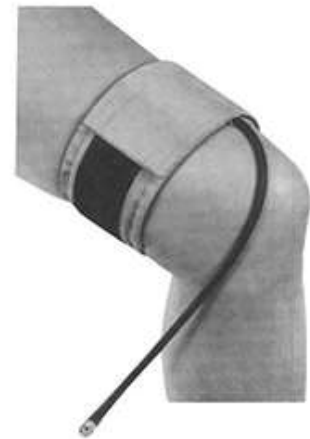

19-104 3 Cuff for the leg
19-105 4 Cuff for the lower arm
19-106 5 Cuff for children
19-107 14 Cuff for the upper arm



19-108
ESMARCH
Staubinde
Compression bandage
5 m lang/long
6 cm breit/wide



19-109
ESMARCH
Stauschlauch
Compression tube
1 m lang/long

Rongeurs

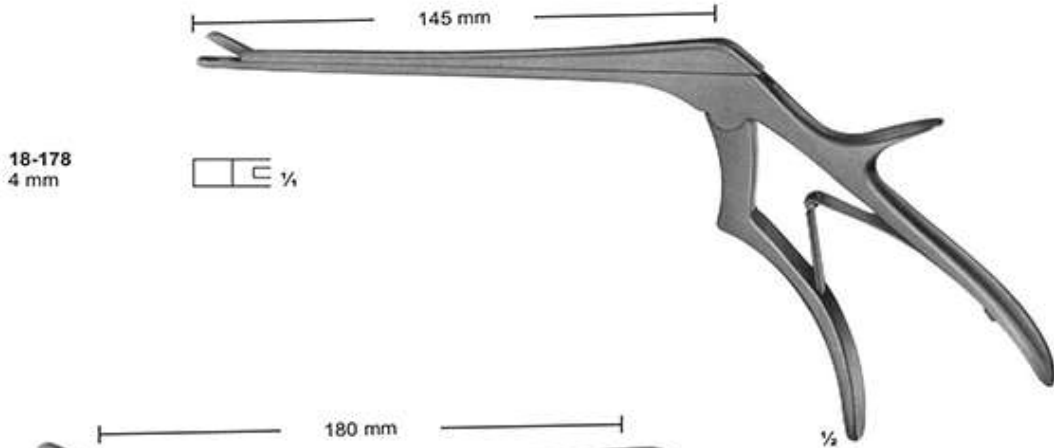

18-178
CASPAR

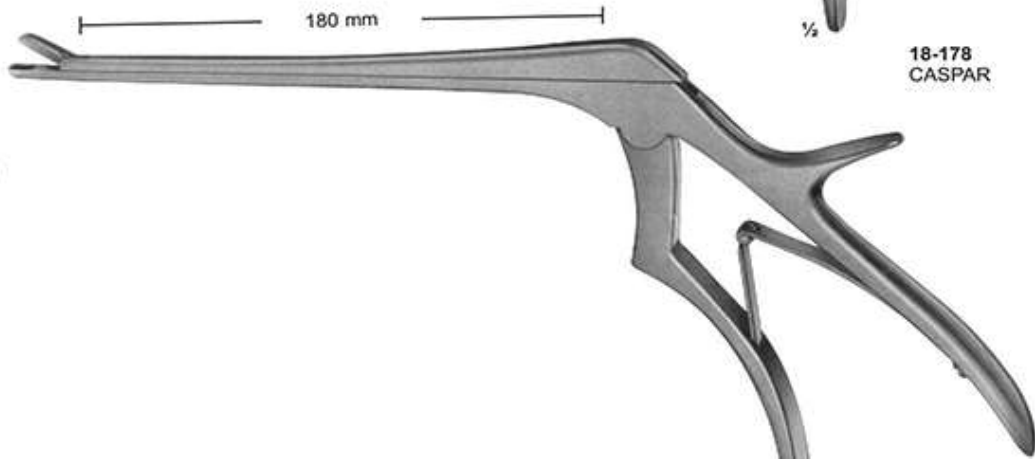

18-179
CASPAR

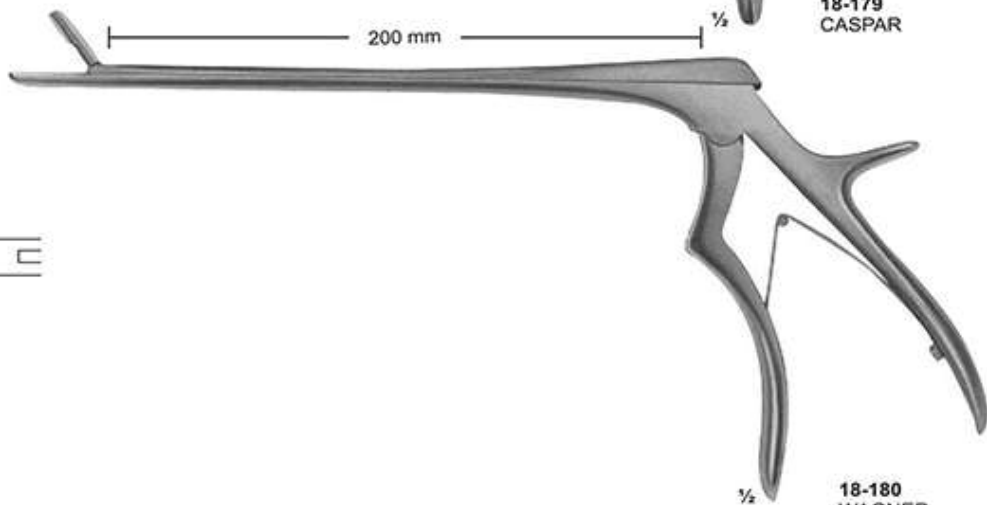

Rongeurs

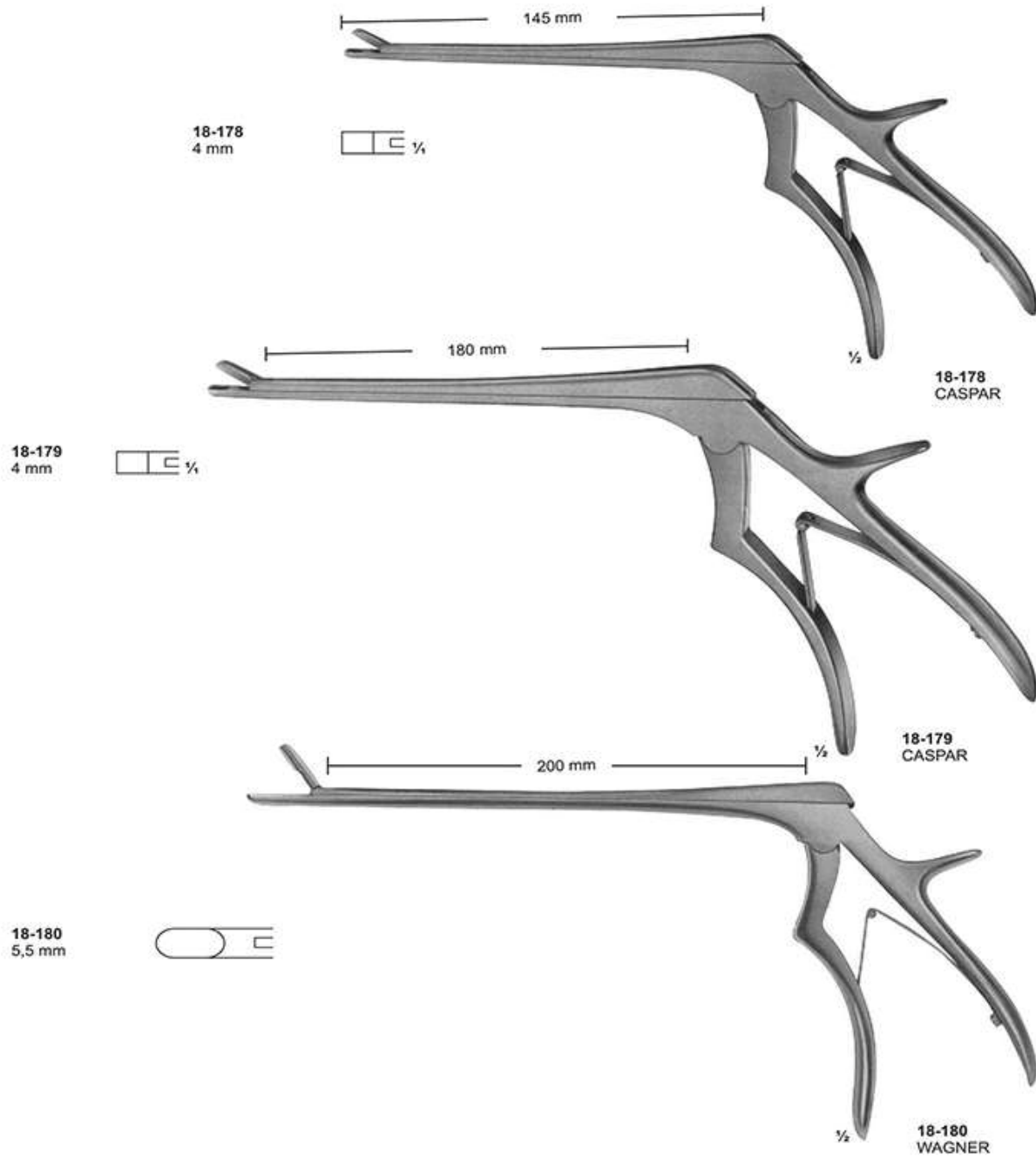

Rongeurs

18-173
3 X 10 mm
LOVE-GRUENWALD



18-174
4 X 10 mm
SPURLING

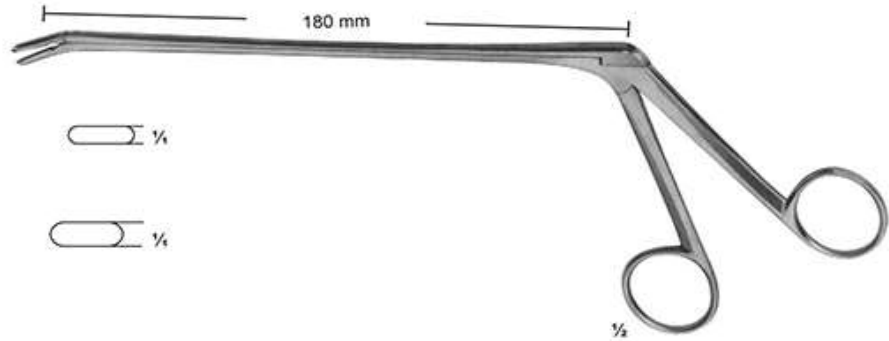

18-173 - 174
LOVE-GRUENWALD

18-175
7 mm

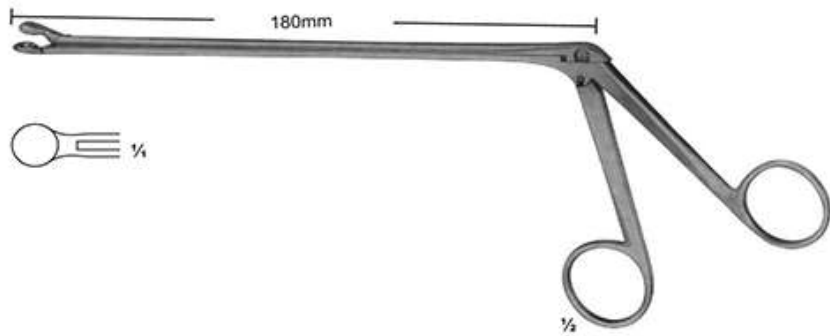

18-175
OLDBERG

18-176
YASARGIL
2,2 mm



18-177
YASARGIL
3,5 mm

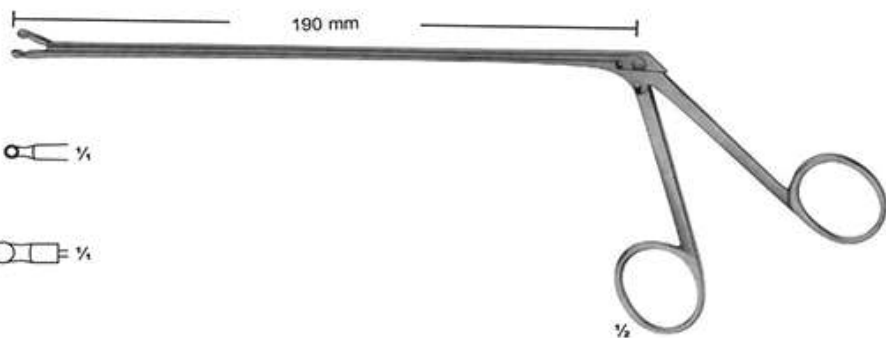

18-176 - 177

Rongeurs

Length of shaft 140 mm	Length of shaft 160 mm	Length of shaft 185 mm	size of jaws
18-162	18-164	185-166	3 X12 mm
18-163	18-165	18-167	4 X14 mm

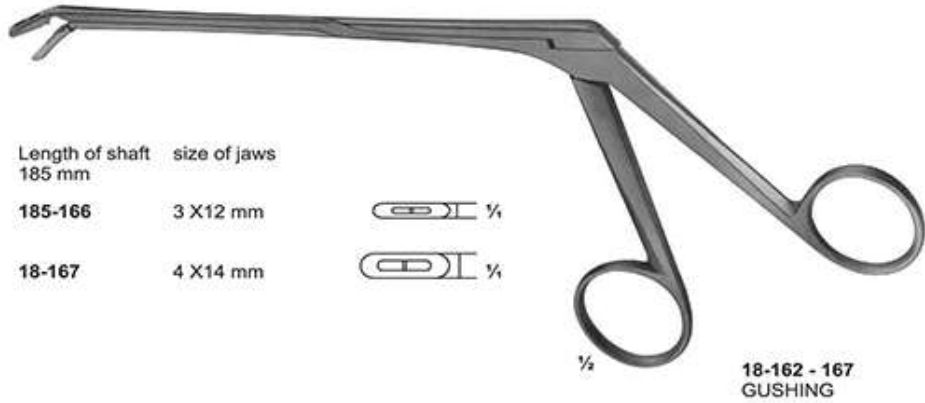
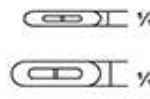

- 18-168**
2 X 10 mm
GUSHING
- 18-169**
3 X 10 mm
LOVE-GRUENWALD
- 18-170**
4 X 10 mm
SPURLING

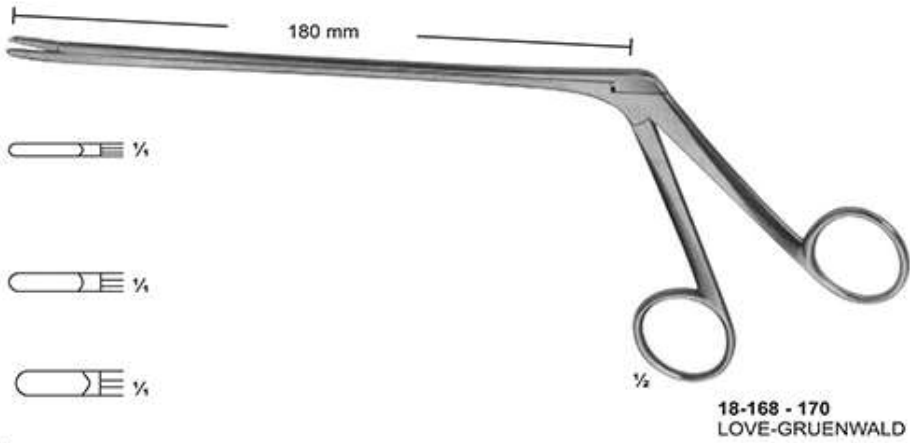

- 18-171**
3 X 10 mm
LOVE-GRUENWALD
- 18-172**
4 X 10 mm
SPURLING

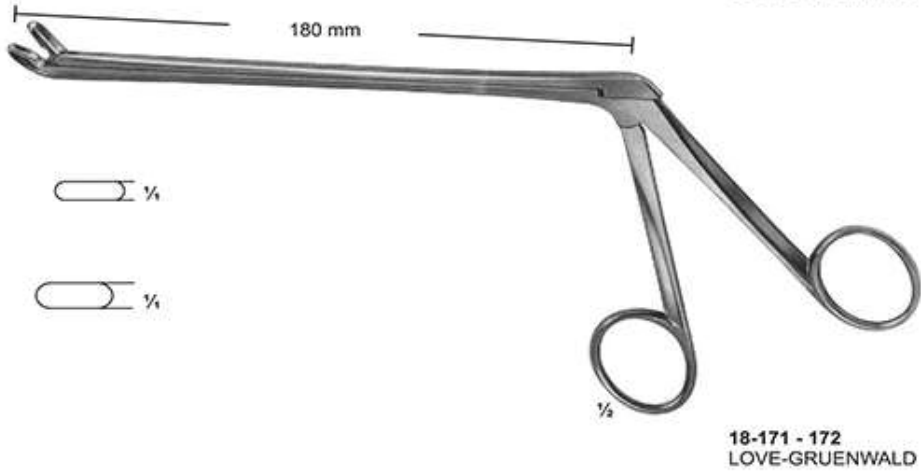

Rongeurs

155 mm

18-135
2 mm

18-136
3 mm

18-137
4 mm

1/2

18-135 - 137
CASPAR

Length of shaft 140 mm	Length of shaft 160 mm	Length of shaft 185 mm	size of jaws
18-138	18-143	18-148	2 X12 mm
18-139	18-144	18-149	3 X12 mm
18-140	18-145	18-150	4 X14 mm
18-141	18-146	18-151	5 X14 mm
18-142	18-147	18-152	6 X16 mm

1/2

18-138 - 152
CASPAR

Length of shaft 140 mm	Length of shaft 160 mm	Length of shaft 185 mm	size of jaws
18-153	18-156	18-159	3 X12 mm
18-154	18-157	18-160	4 X14 mm
18-155	18-158	18-161	5 X14 mm

1/2

18-153 - 161
CASPAR

Rongeurs

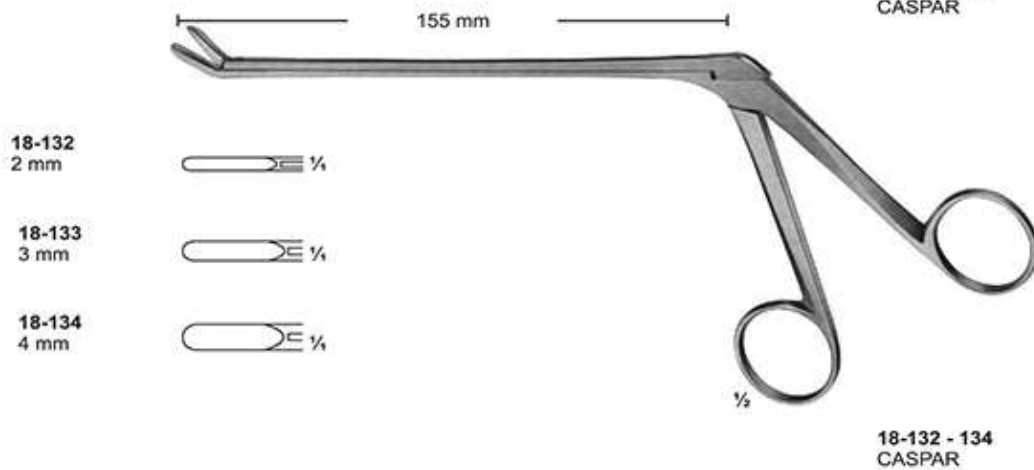
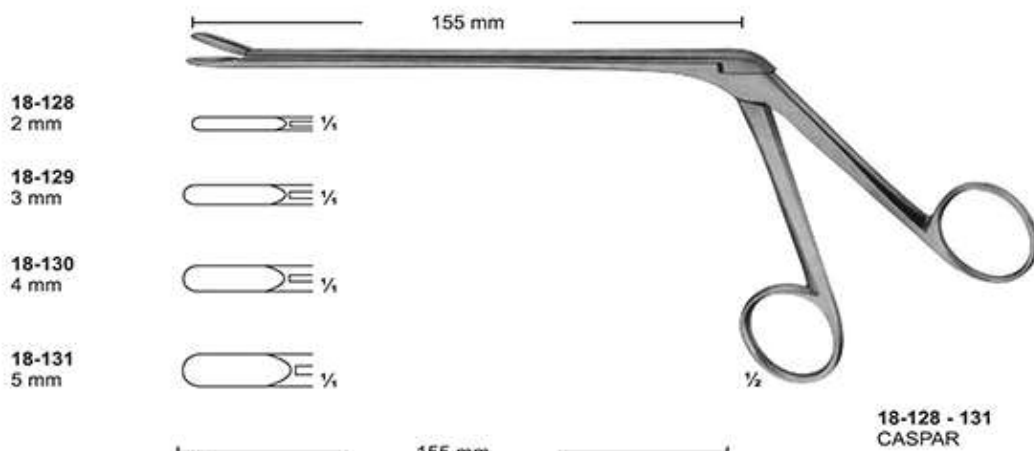
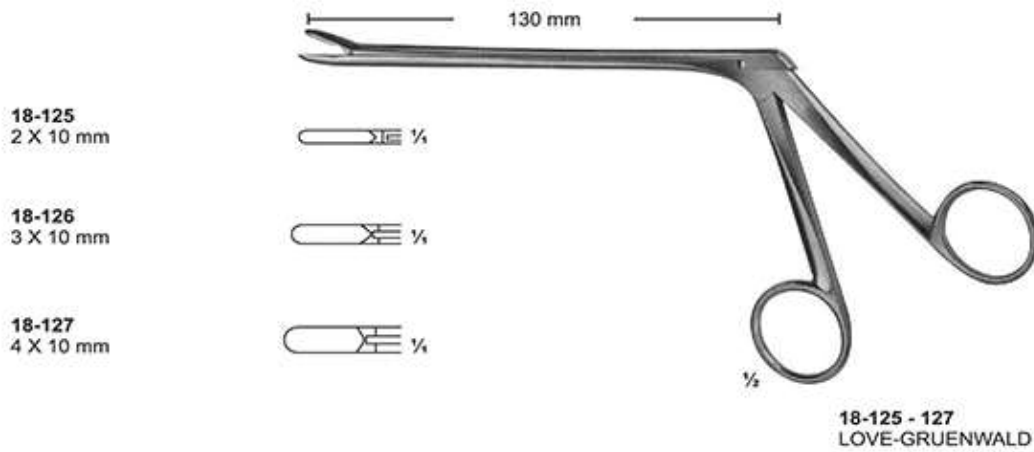

Rongeurs

Angled positions for rongeurs

- 18-118
3,0 mm
- 18-119
3,6 mm
- 18-120
4,2 mm
- 18-121
4,8 mm
- 18-122
5,8 mm

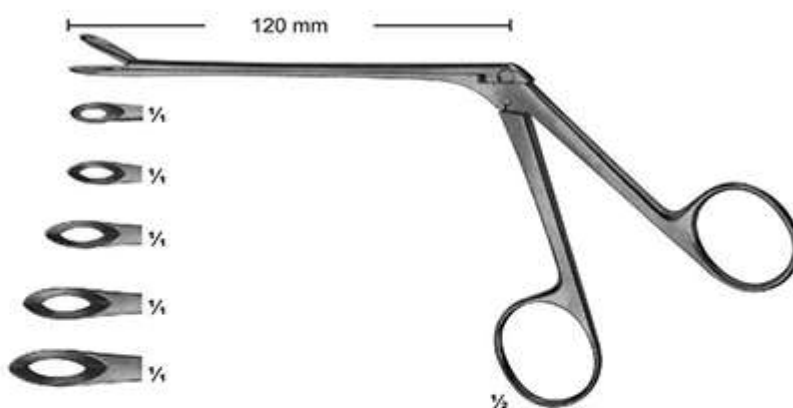

18-118 - 122
WEIL-BLAKESLEY

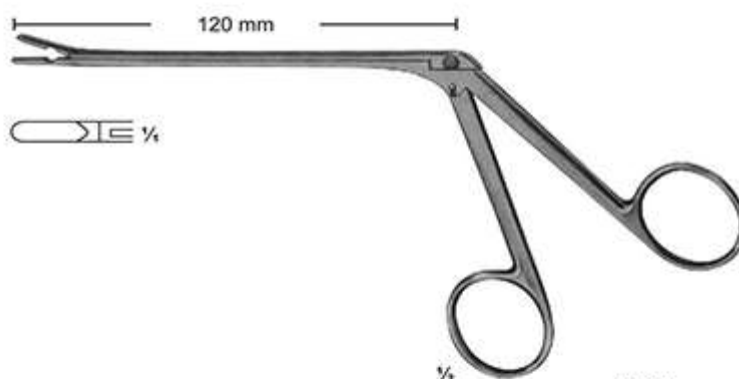

18-123
TAKAHASHI
3 mm

130°

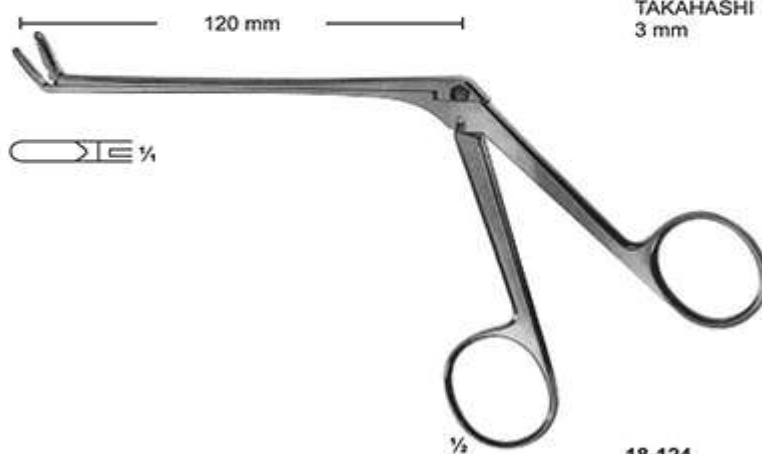

18-124
TAKAHASHI
3 mm

Punches

130° upwards cutting

- 18-108
1 mm 
- 18-109
2 mm 
- 18-110
3 mm 
- 18-111
4 mm 
- 18-112
5 mm 

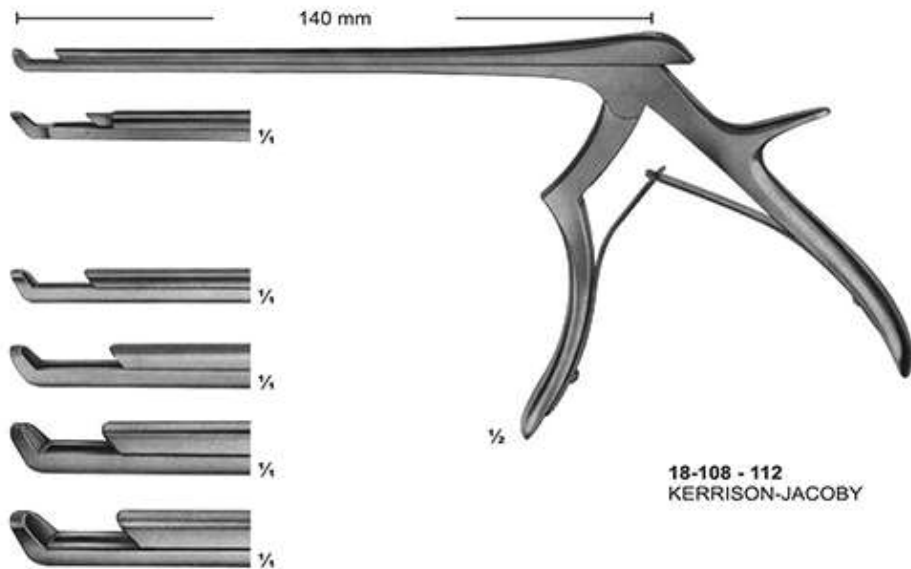

18-108 - 112
KERRISON-JACOBY

90° upwards cutting

- 18-113
1 mm 
- 18-114
2 mm 
- FERRIS-SMITH-KERRISON
- 18-115
3 mm 
- 18-116
4 mm 
- 18-117
5 mm 

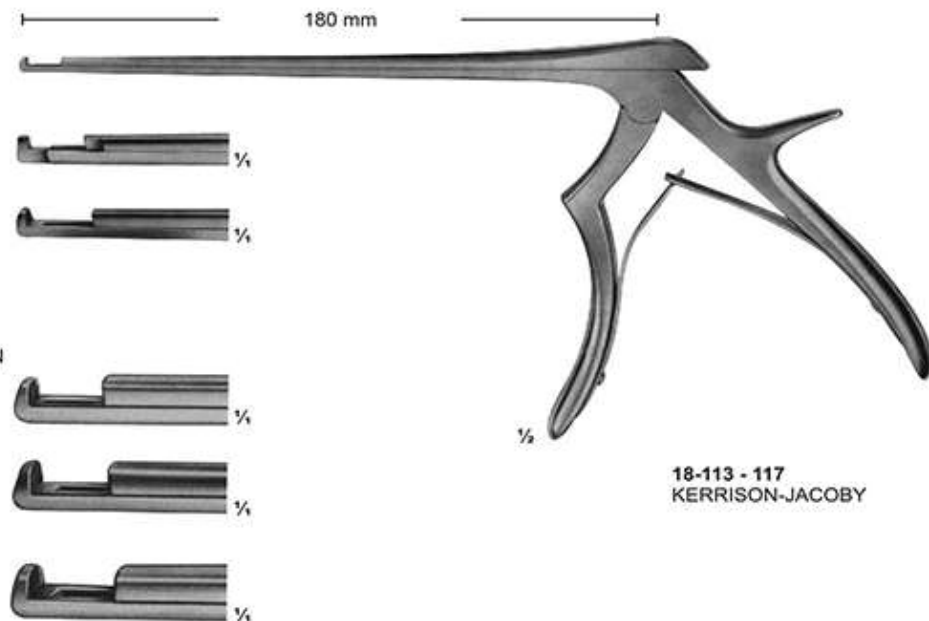

18-113 - 117
KERRISON-JACOBY

Punches

90° upwards cutting

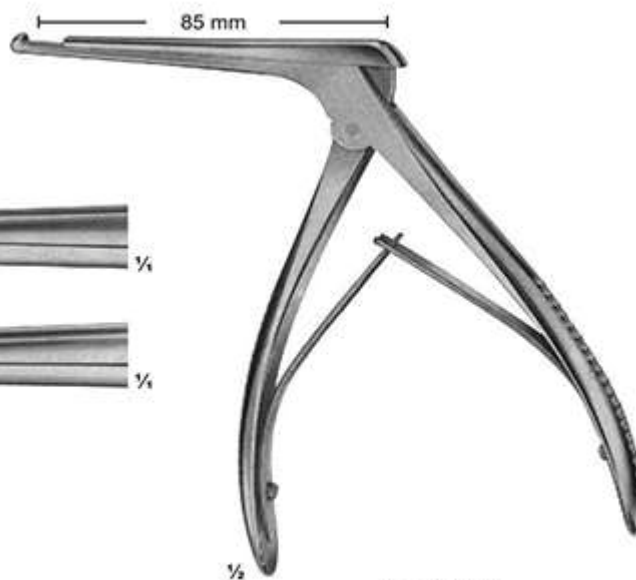

18-104
4 mm



1/4

18-105
5 mm



1/4

18-104 - 105
KERRISON

90° upwards cutting

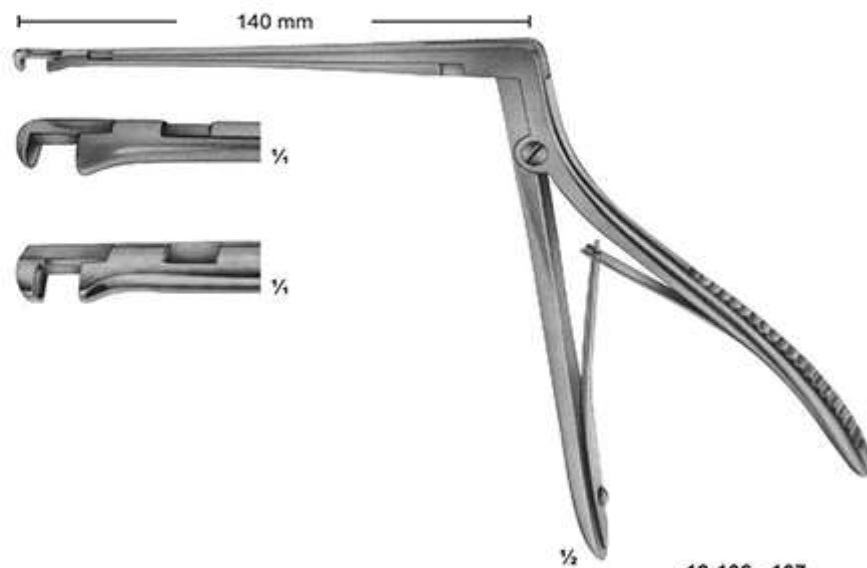

18-106
3,3 mm



1/4

18-107
4,0 mm



1/4

18-106 - 107
HAJEK-KOFLER

Punches

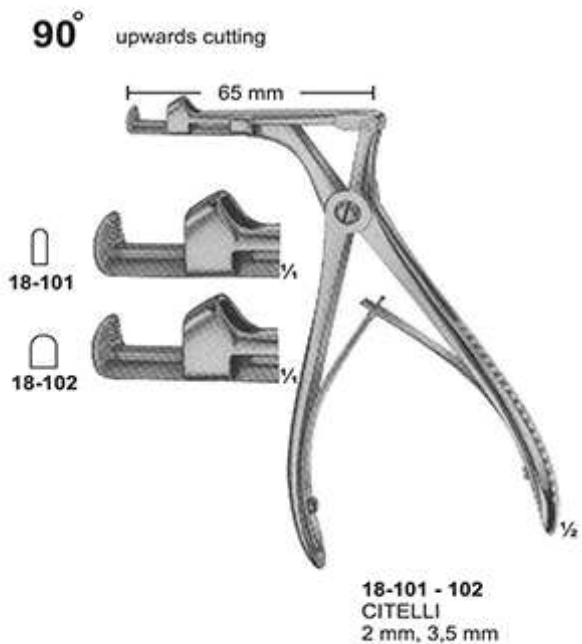
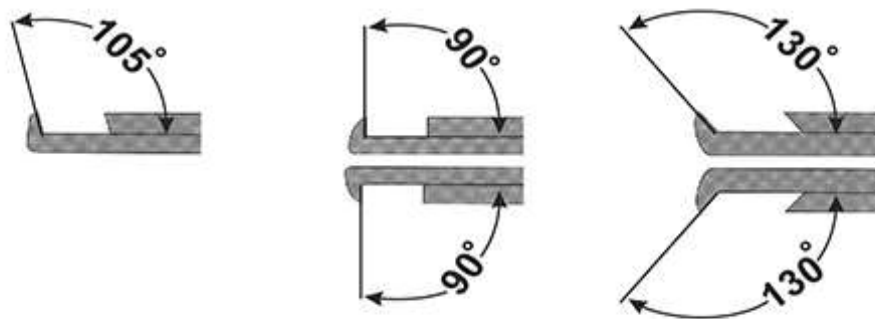

Rib Spreaders-and Contractors



17-422
ALLISON
255 mm



17-423
ALLISON
320 mm



ϕ 6-10 mm
1/4

17-424
DE BAKKEY
With central bore,
3.0mm diam.
with lateral slots
275 mm



ϕ 7-9 mm
1/2

17-425
YANKAUER
With central bore,
2.0mm diam.
285 mm

Rib Spreaders-and Contractors

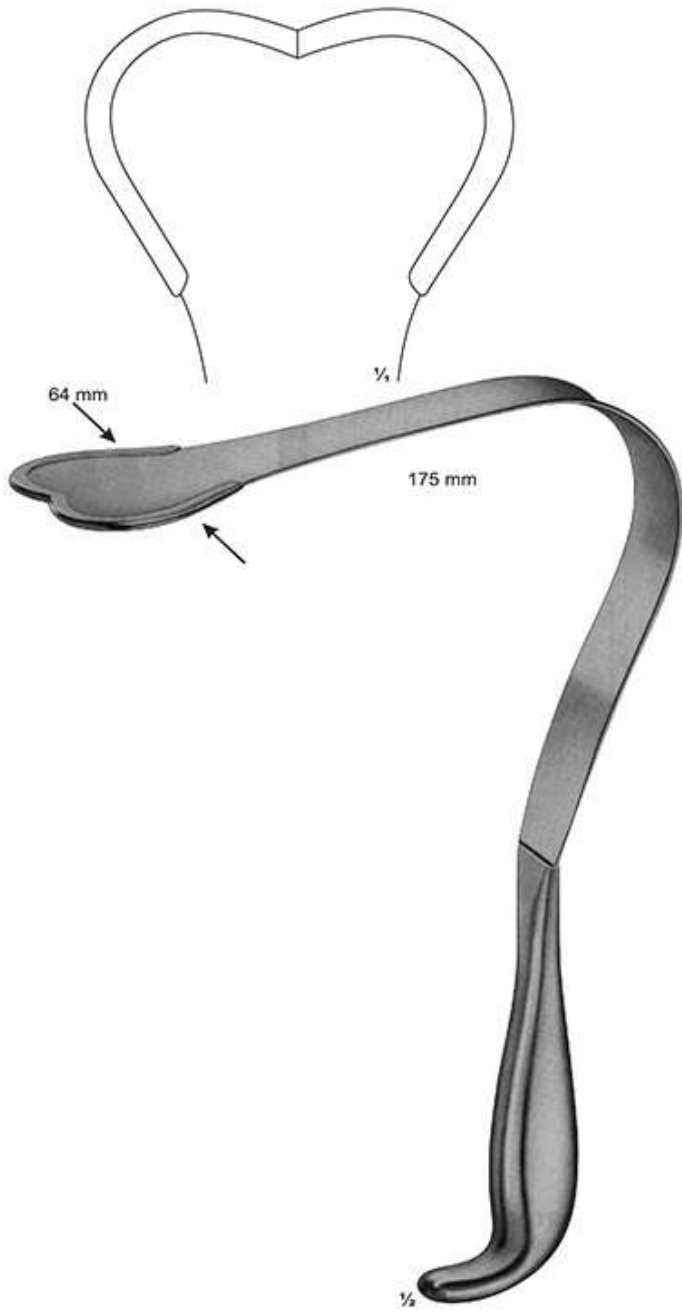

17-420
HARRINGTON-PEMBERTON
federnd/flexible
295 mm



17-421
DAVIDSON
Scalpel haken

Rib Spreaders-and Contractors



17-416
SELLORS
Rib spreader-and contractor
with swivel blades
200 mm



17-417
BAILEY
150 mm



17-418
for children

17-419
for children

17-418 - 419
BAILEY
200 mm

Thoracic Retractors



17-414
Blades
75x75 mm



17-415
Blades
42x65 mm

Blades with Ball Snap System
Delivery: in Pairs

- 17-413 - 415**
Thoraxsperrer (Mercedes-Sperrer)
complete consisting of:
17-413 Retractor only
17-414 1 Pair of blades 42x65 mm
17-415 1 Pair of blades 75x75 mm

Sternotomy-Spreaders

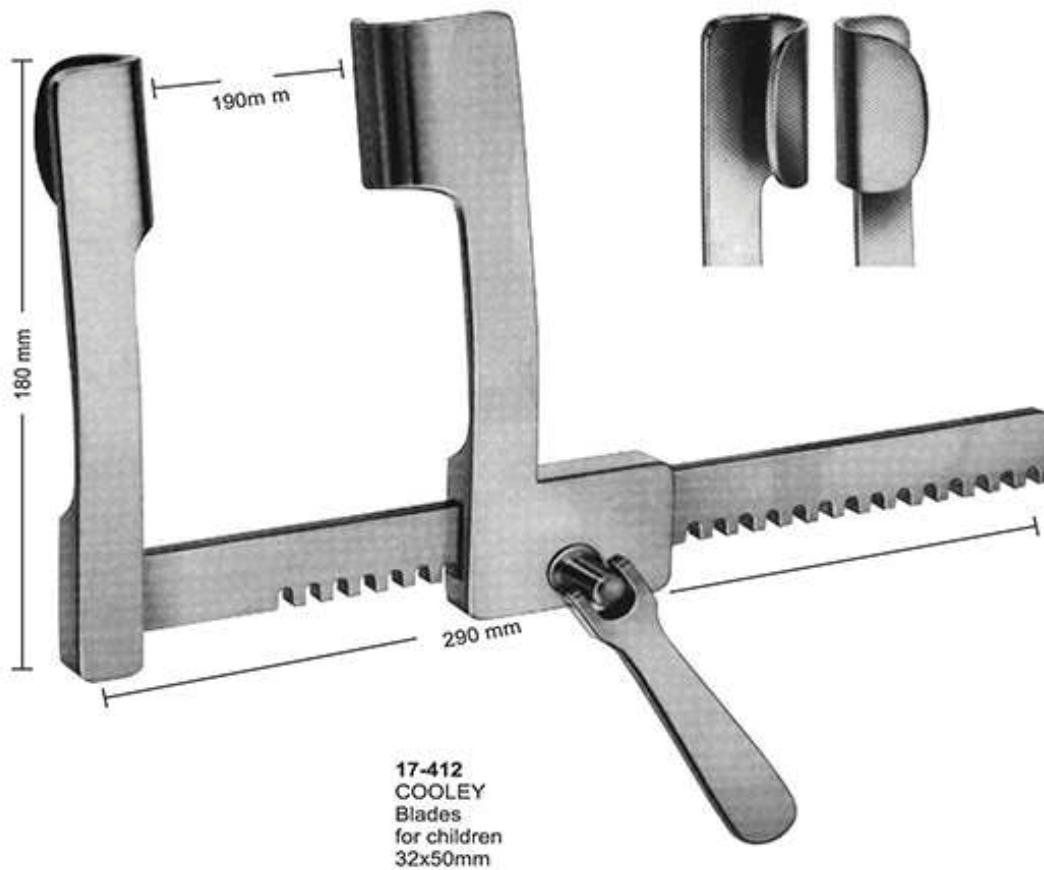
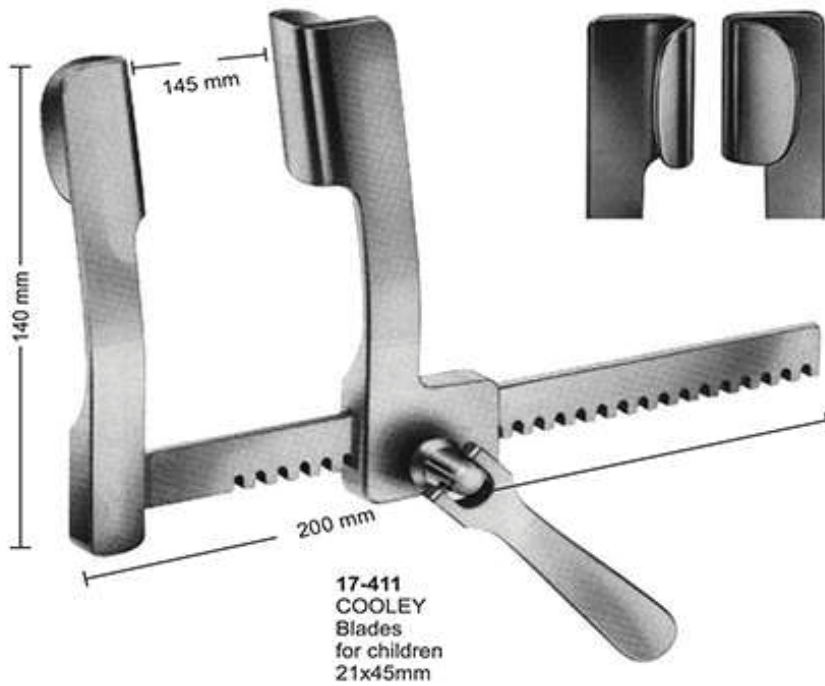

Sternotomy-Spreaders

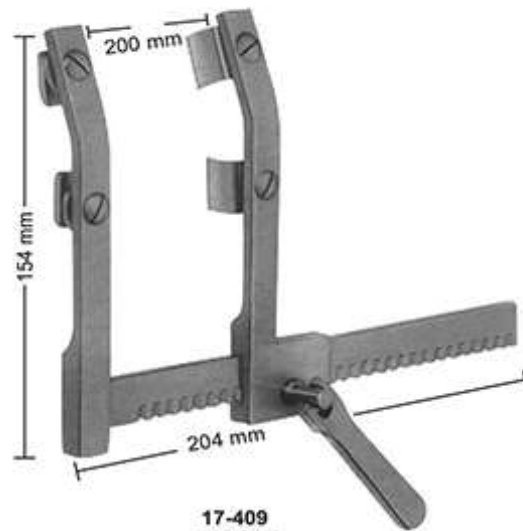

17-409
MORSE
Sternotomy spreader
for children, with moveable
double, each blade
12x20 mm

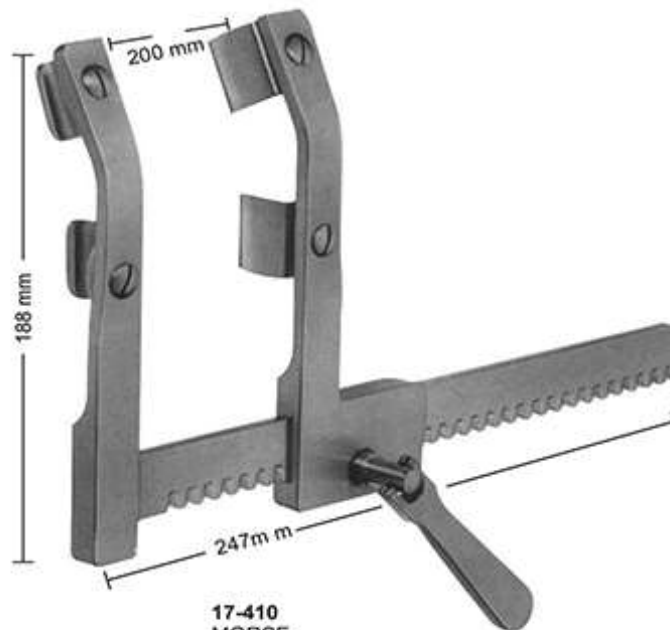

17-410
MORSE
Sternotomy spreader
for adults, with moveable
double, each blade
19x19 mm

Rib Spreaders

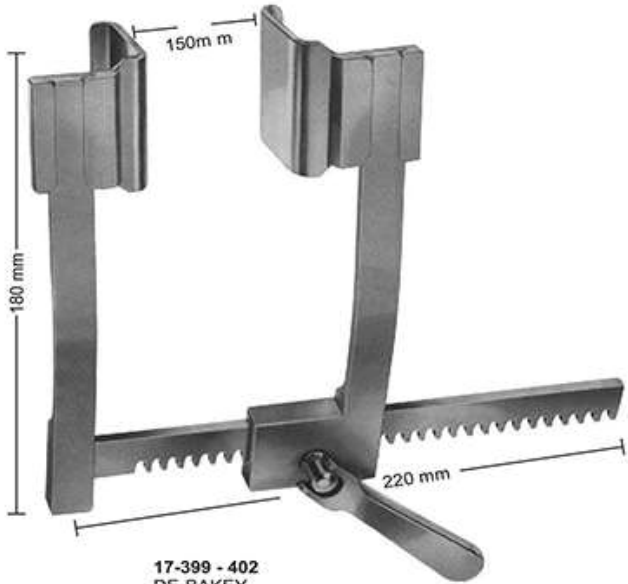

17-399 - 402
DE-BAKEY
with 3 pairs of blades



17-400
Blades
30x30 mm



17-401
Blades
40x40 mm



17-402
Blades
50x50 mm

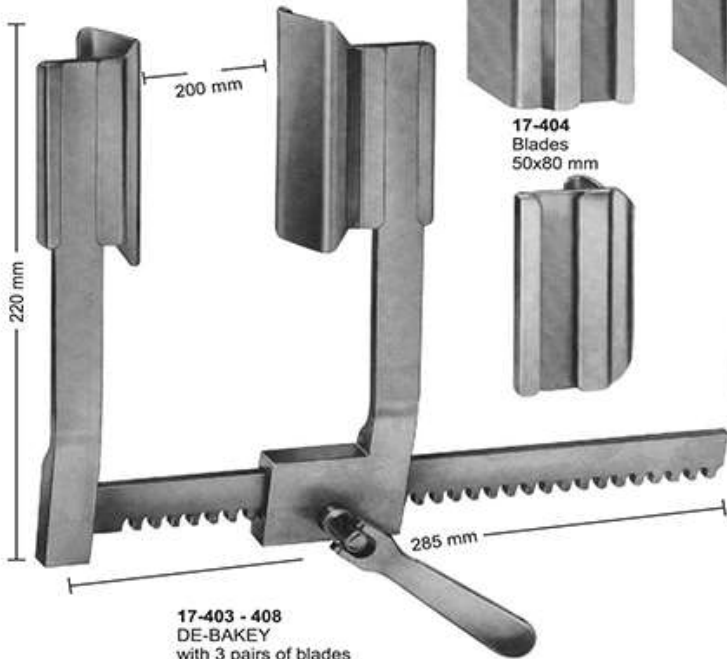

17-403 - 408
DE-BAKEY
with 3 pairs of blades



17-404
Blades
50x80 mm



17-405
Blades
80x60 mm



17-406
Blades
50x80 mm



17-407
Blades
40x100 mm

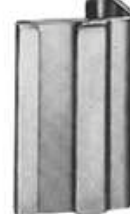
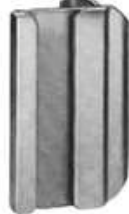

17-408
Sternotomy Blades
50x660 mm



Rib Spreaders

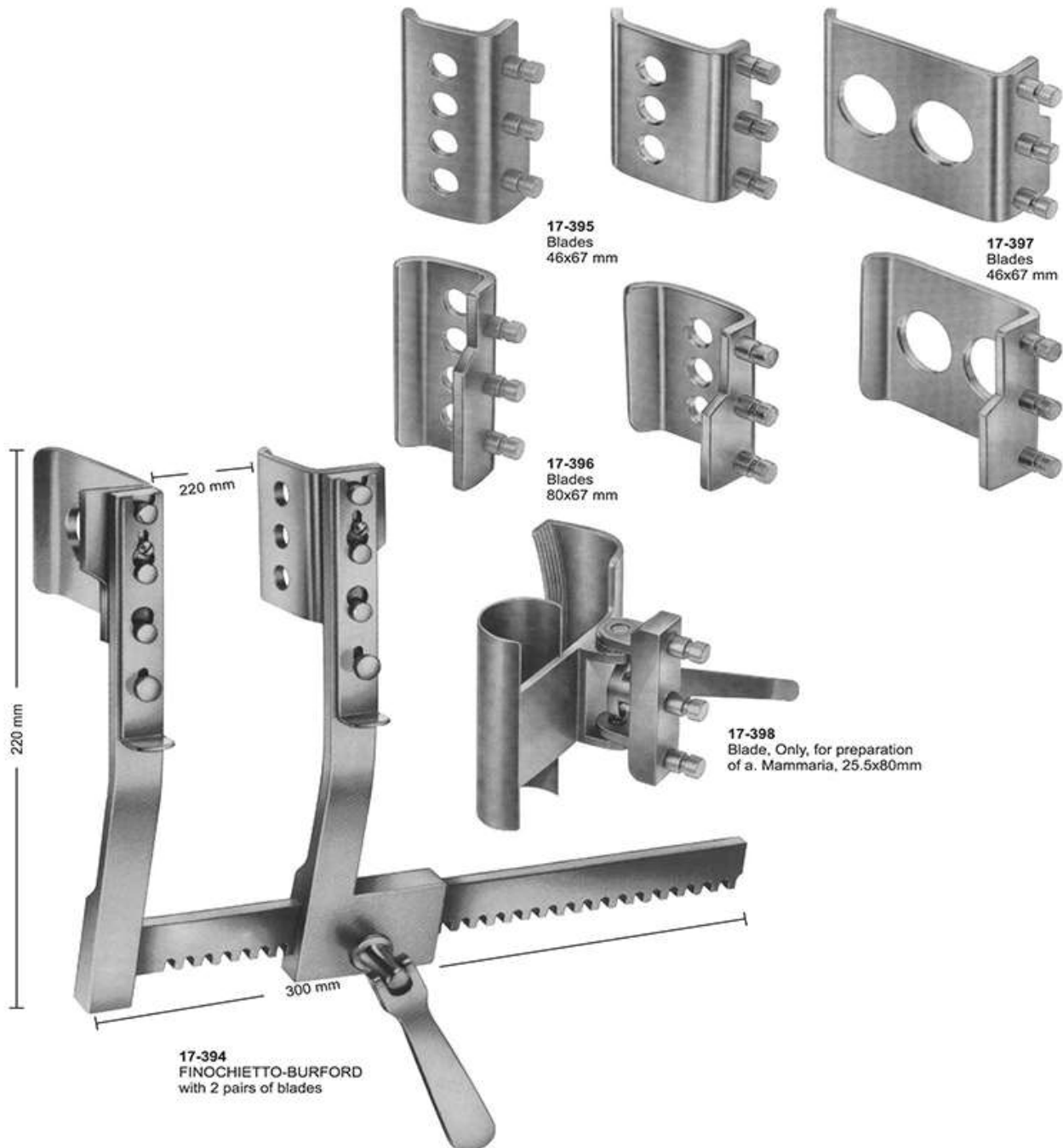

Rib Spreaders

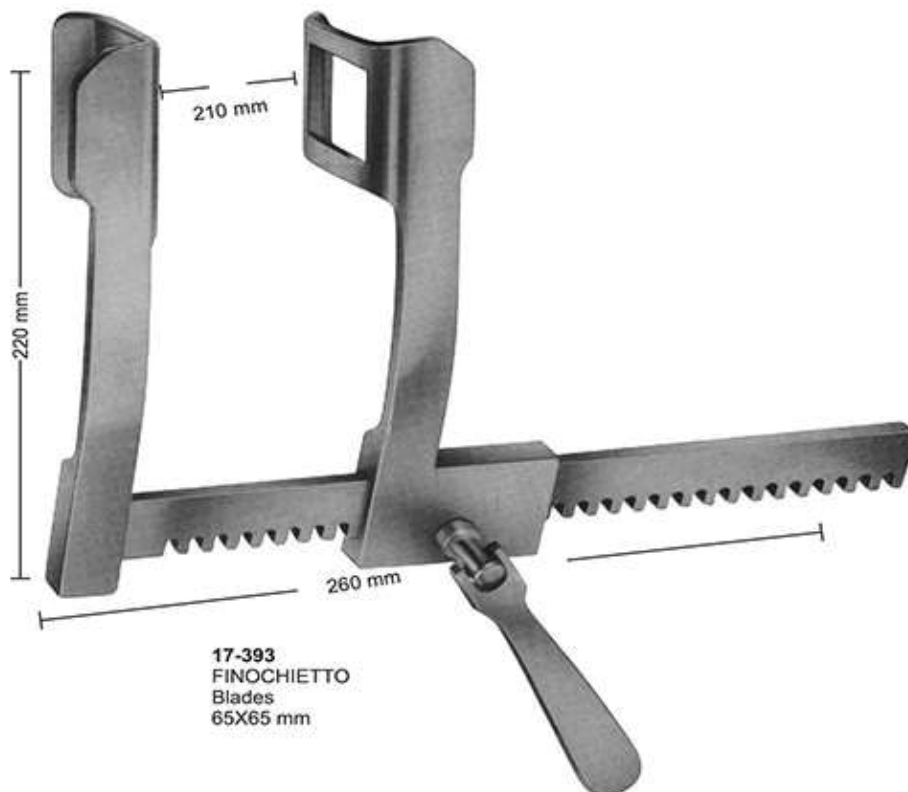
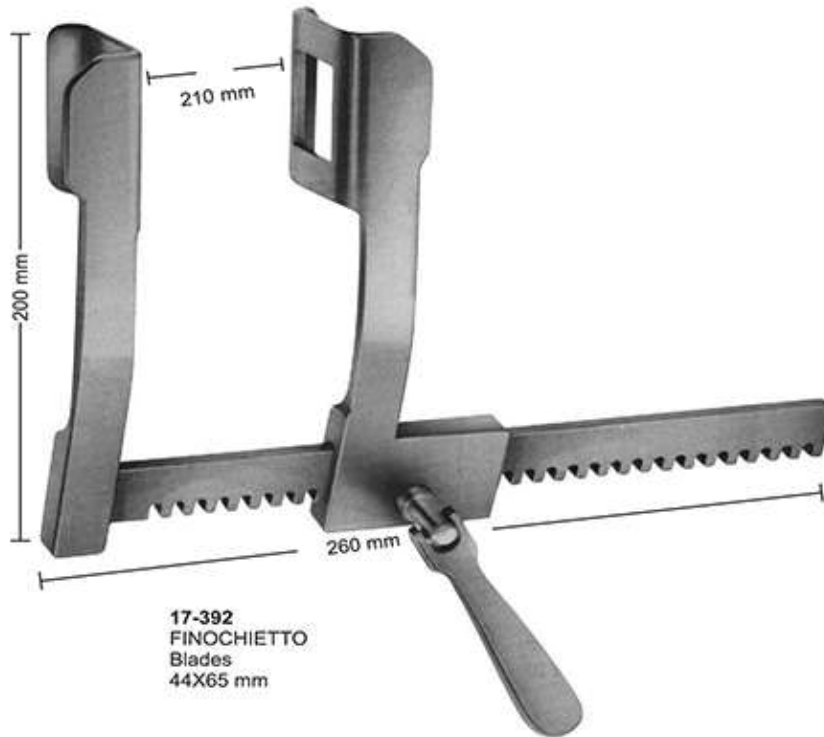

Rib Spreaders

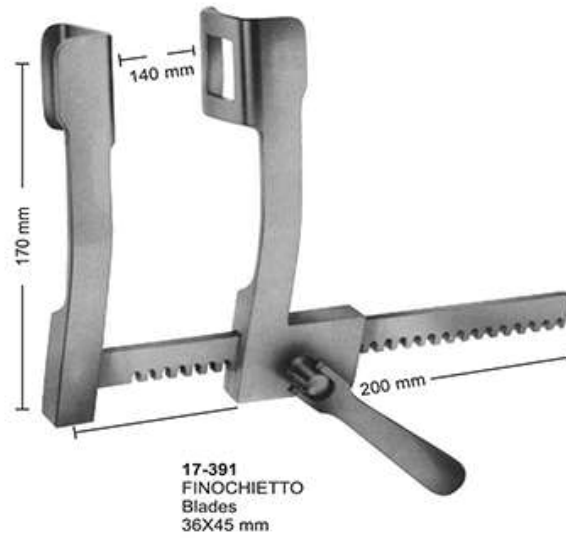
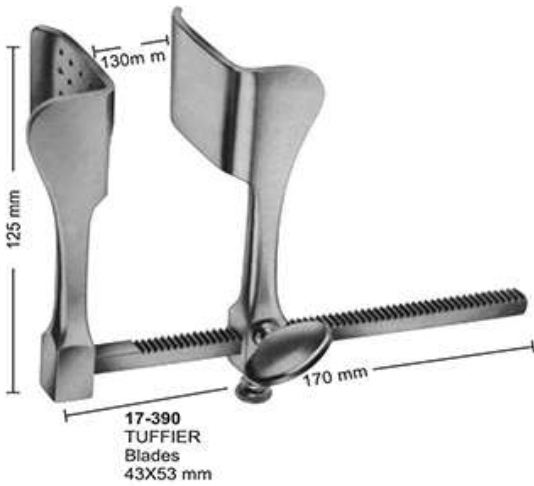
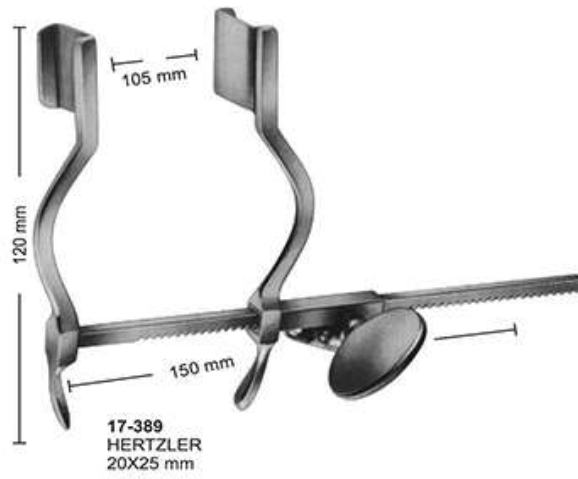
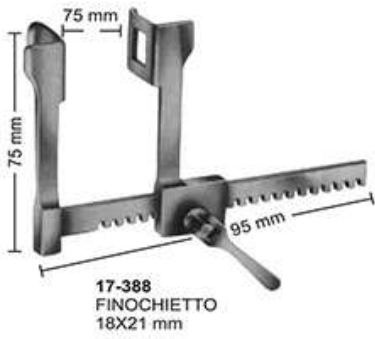

Rib Raspatories



17-376
190 mm

17-377

17-378

17-379

17-380

1/2
17-376 - 380
SEMB
230 mm

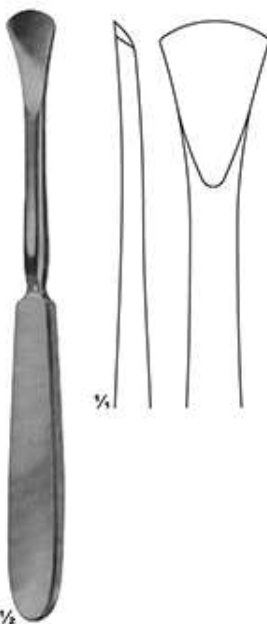

17-381
LANGENBECK
190 mm

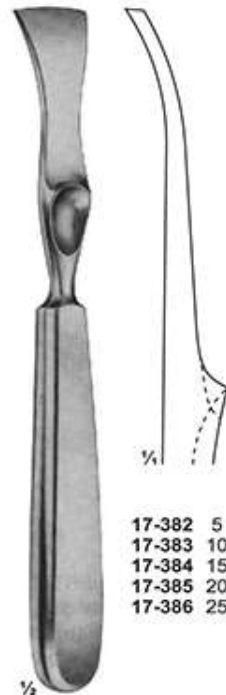

17-382 - 386
LAMBOTTE
215 mm

- 17-382 5 mm
- 17-383 10 mm
- 17-384 15 mm
- 17-385 20 mm
- 17-386 25 mm

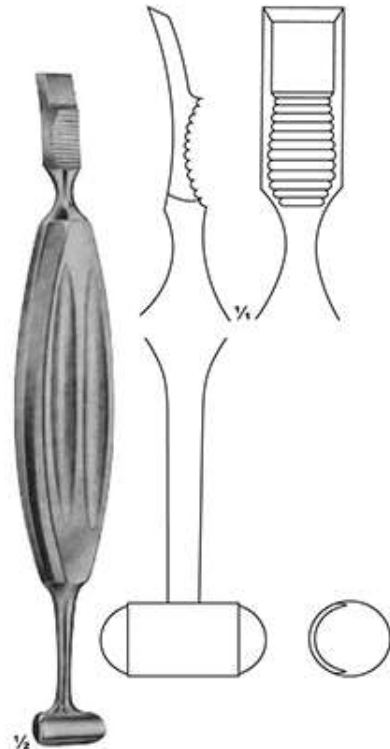

17-387
ALEXANDER
210 mm

Rib Raspatories

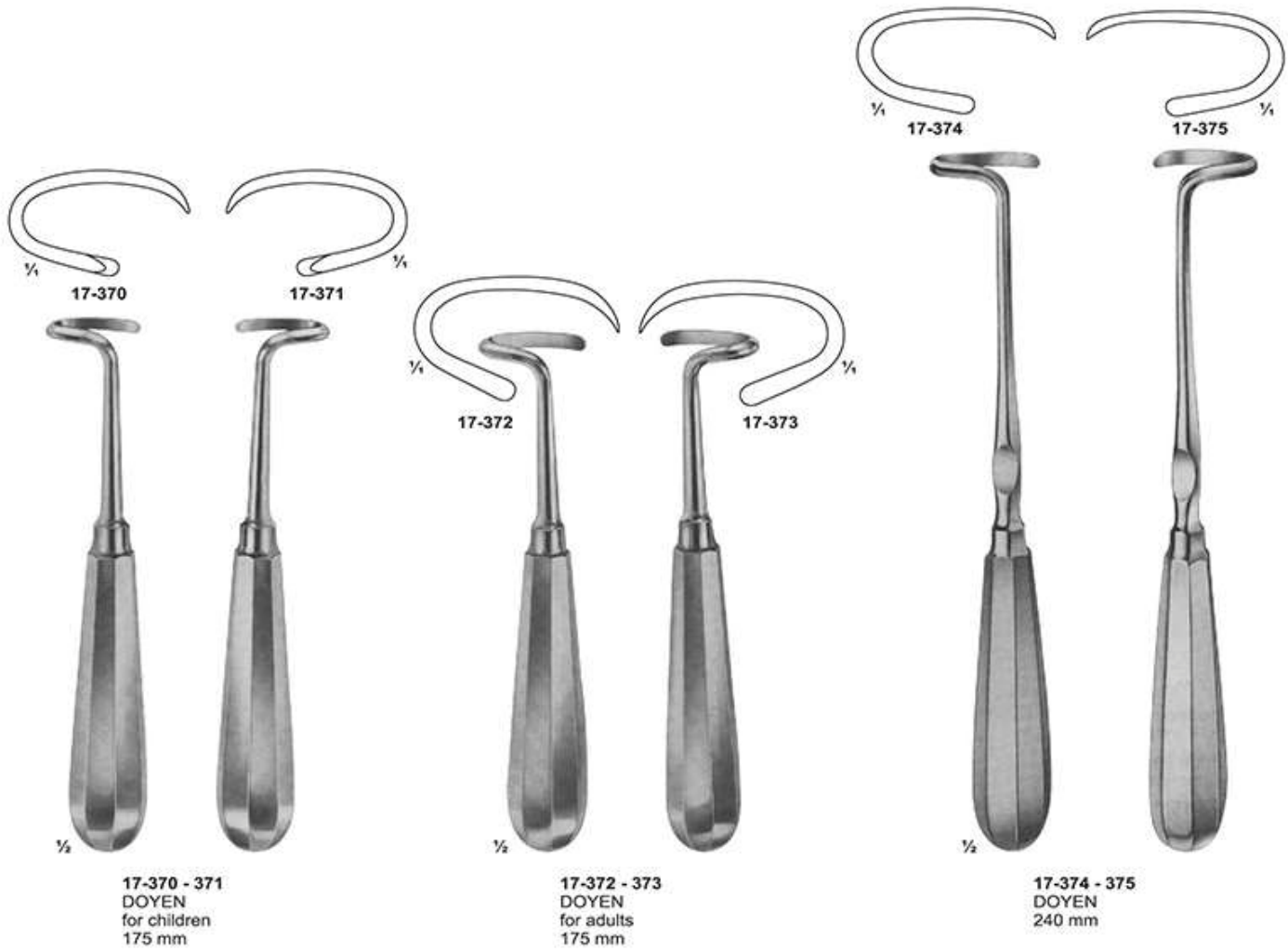

Rib Holding Forceps, Bone Cutting Forceps



17-362
SEMB
Rib-and Bone
Holding forceps
190 mm



17-363
SEMB
Rib-and Bone
Holding forceps
190 mm

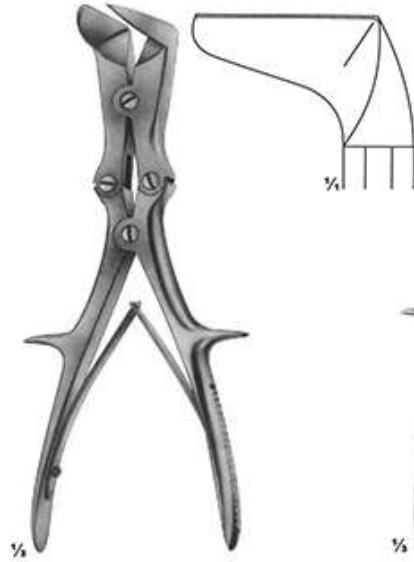

17-364
LISTON-STILLE
265 mm

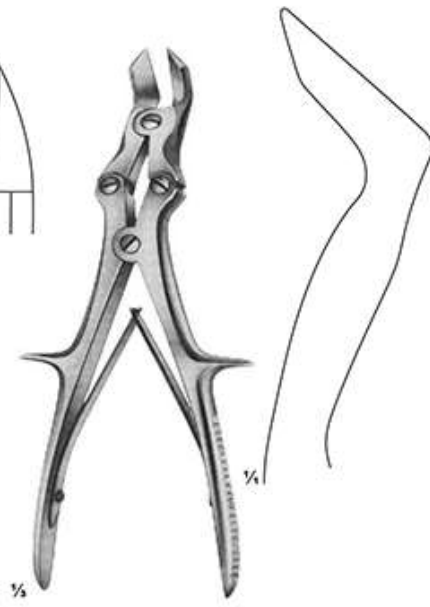

17-365
LISTON-KEY-HORSLEY
255 mm



17-367

17-368

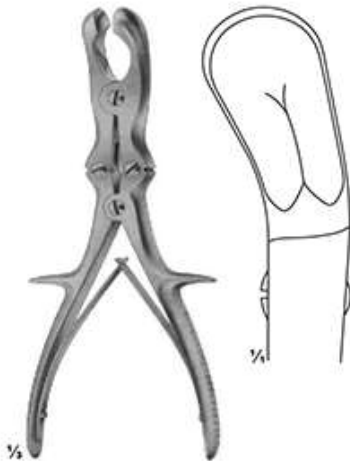

17-366
SEME
Rib Rongeur to shorten
the rib stumps
240 mm



17-367-368
SAUERDRUCH-CORYLLOS
Rib rongeurs to shortn
the rib stumbers
310 mm

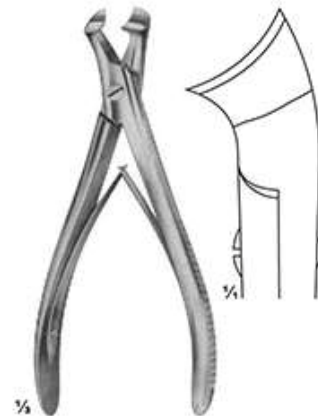

17-369
MARKWALDER
Rib Rongeur to Round
the rib stumps
190 mm

Multi-Purpose Clamps



17-351
PRICE THOMAS
225 mm



17-352
jaws with pins

17-353
jaws with pins

17-352 - 353
PRICE THOMAS
225 mm

Multi-Purpose Clamps



17-347
PERTUISET
Carotid Clamp
90 mm



17-348
CRAFOORD-SELLORS
240 mm

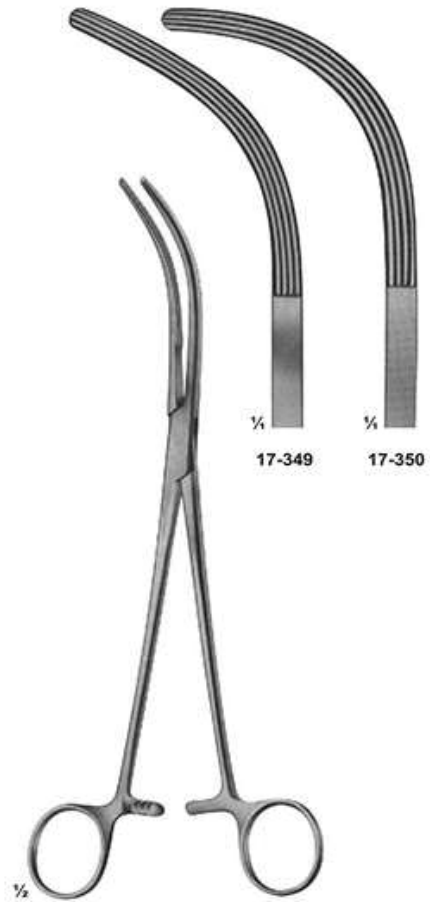

17-349 - 350
CRAFOORD
240 mm

Multi-Purpose Clamps

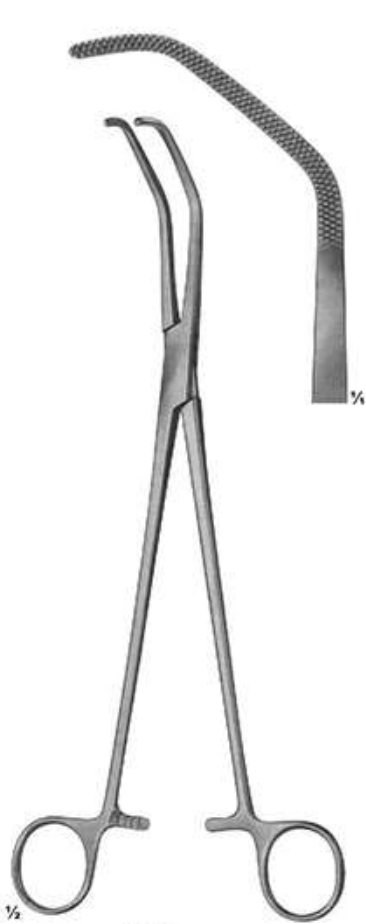

17-344
SATINSKY
265 mm



17-345
SATINSKY
265 mm



17-346
HARKEN
240 mm

Multi-Purpose Clamps



17-340
MIXTER
230 mm

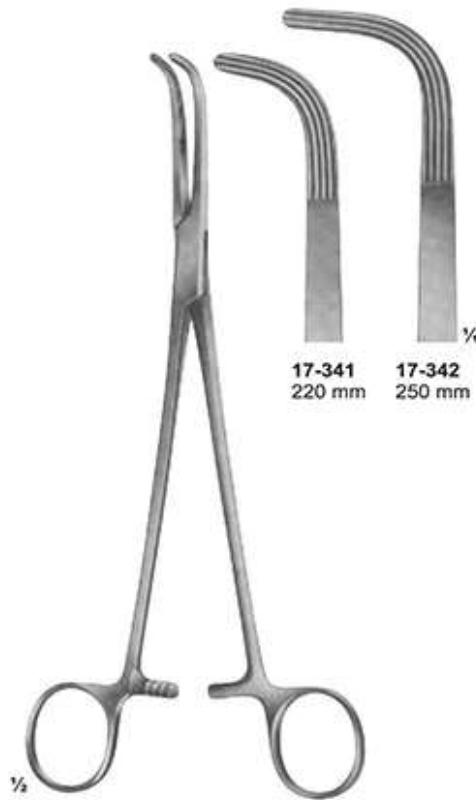

17-341 **17-342**
220 mm 250 mm

17-341 - 342
MIXTER



17-343
HOPFNER
160 mm

Multi-Purpose Clamps

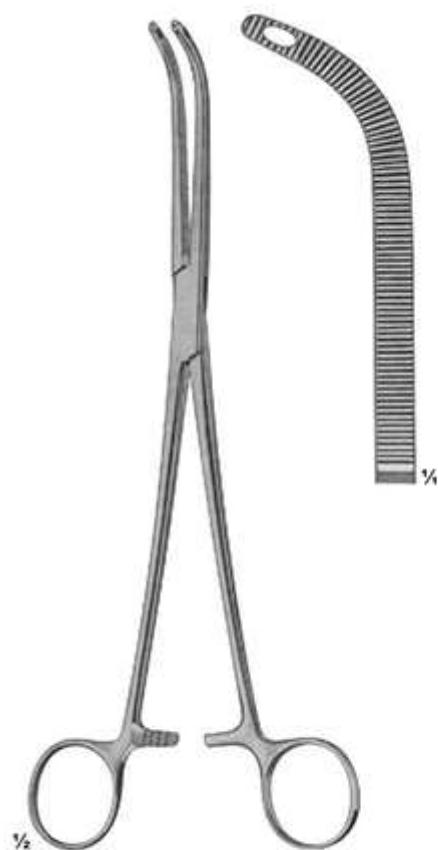

17-336
FINOCHIETTO
245 mm

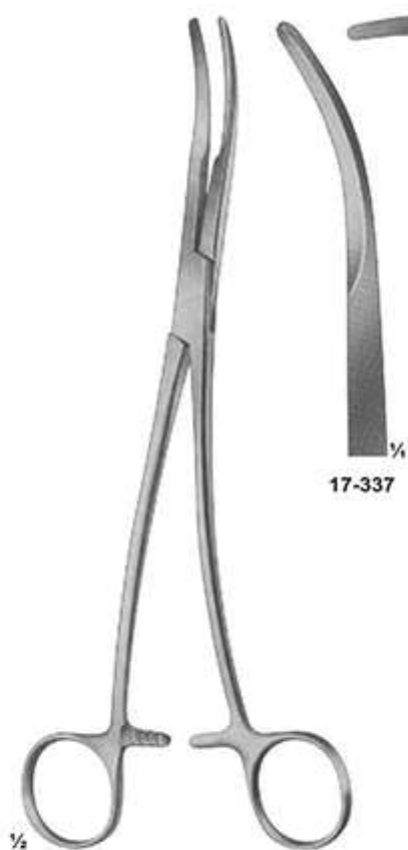

17-337 - 338
SEMB
244 mm



17-338

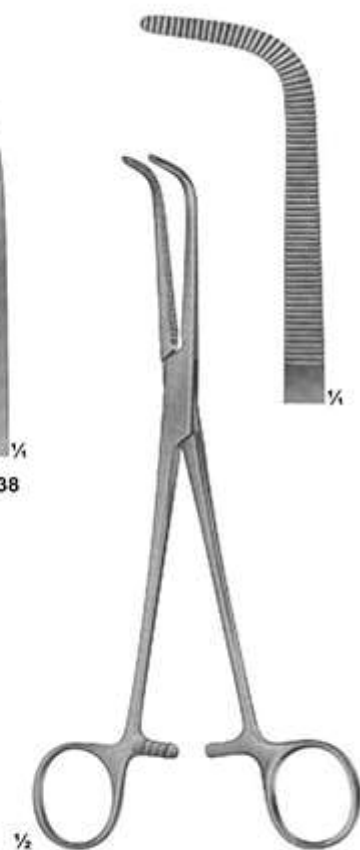

17-339
WIKSTROEM
205 mm

Multi-Purpose Clamps



17-328
WILLIAMS
160 mm



17-329
TUTTLE
230 mm



17-330
NELSON
230 mm

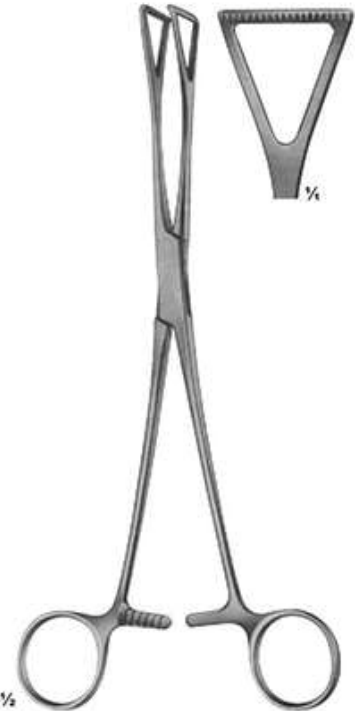

17-331
DUVAL
230 mm



BABCOCK
17-332 170 mm
17-333 215 mm
17-334 220 mm



17-335
ALLIS
220 mm

Multi-Purpose Clamps



DARDIK

17-318	150 mm	17-323	170 mm
17-319	150 mm	17-324	170 mm
17-320	150 mm	17-325	170 mm
17-321	145 mm	17-326	160 mm
17-322	130 mm	17-327	135 mm

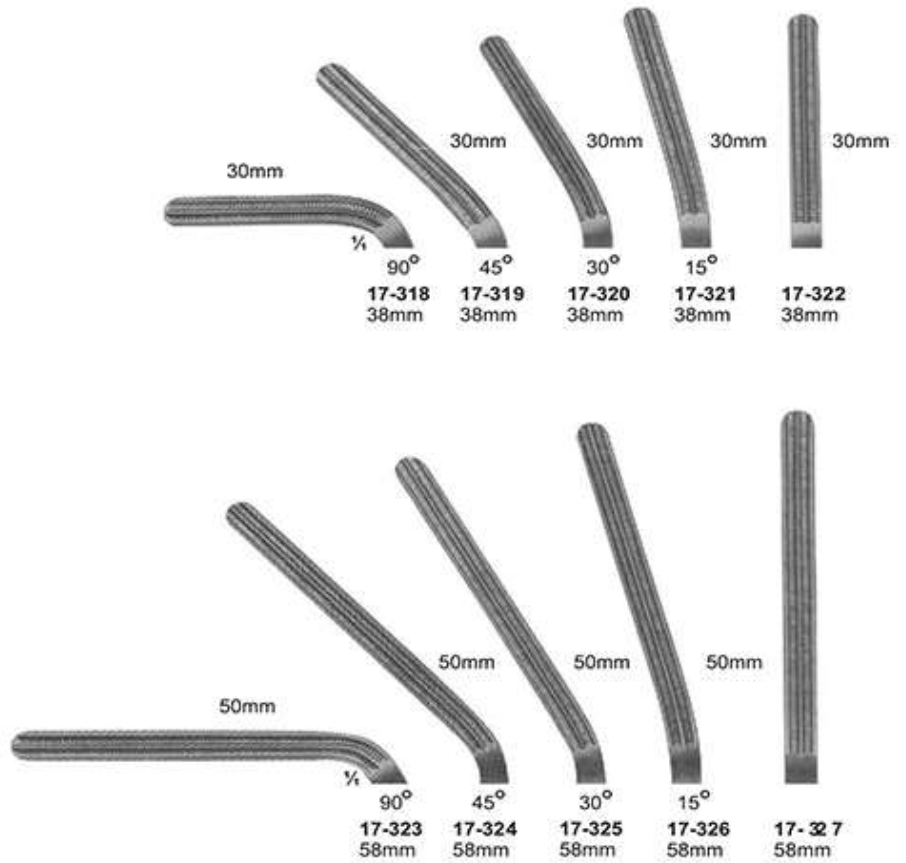

Aorta-Anastomosis Clamps

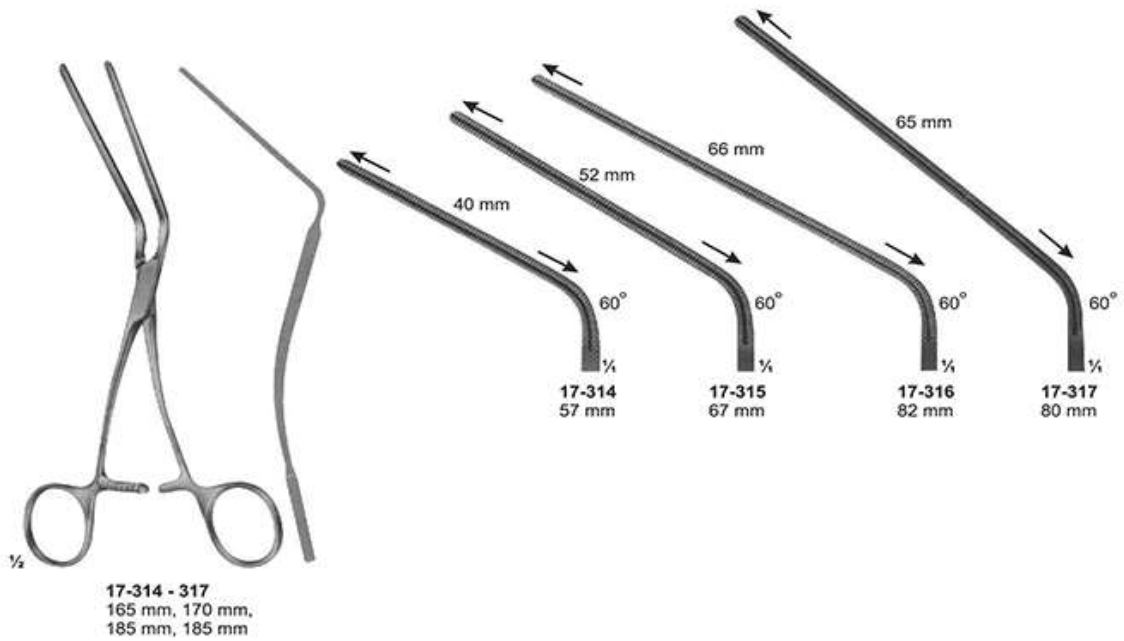
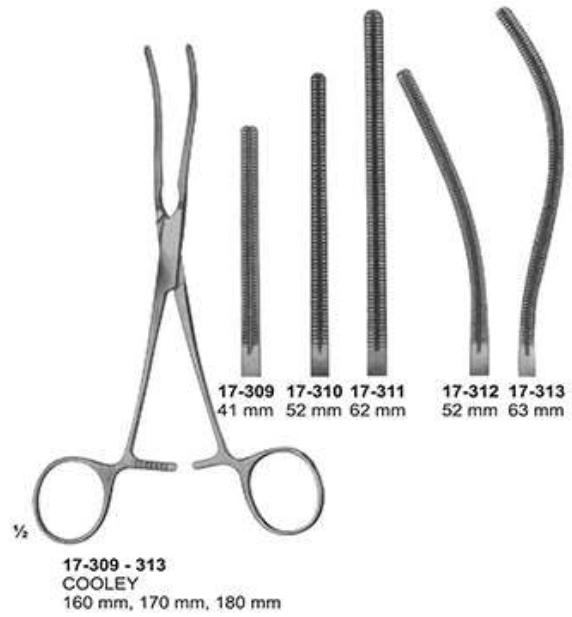
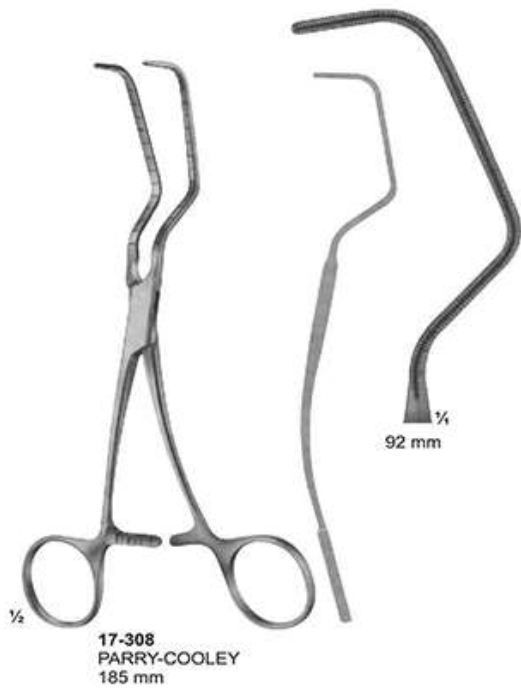

Aorta-Anastomosis Clamps

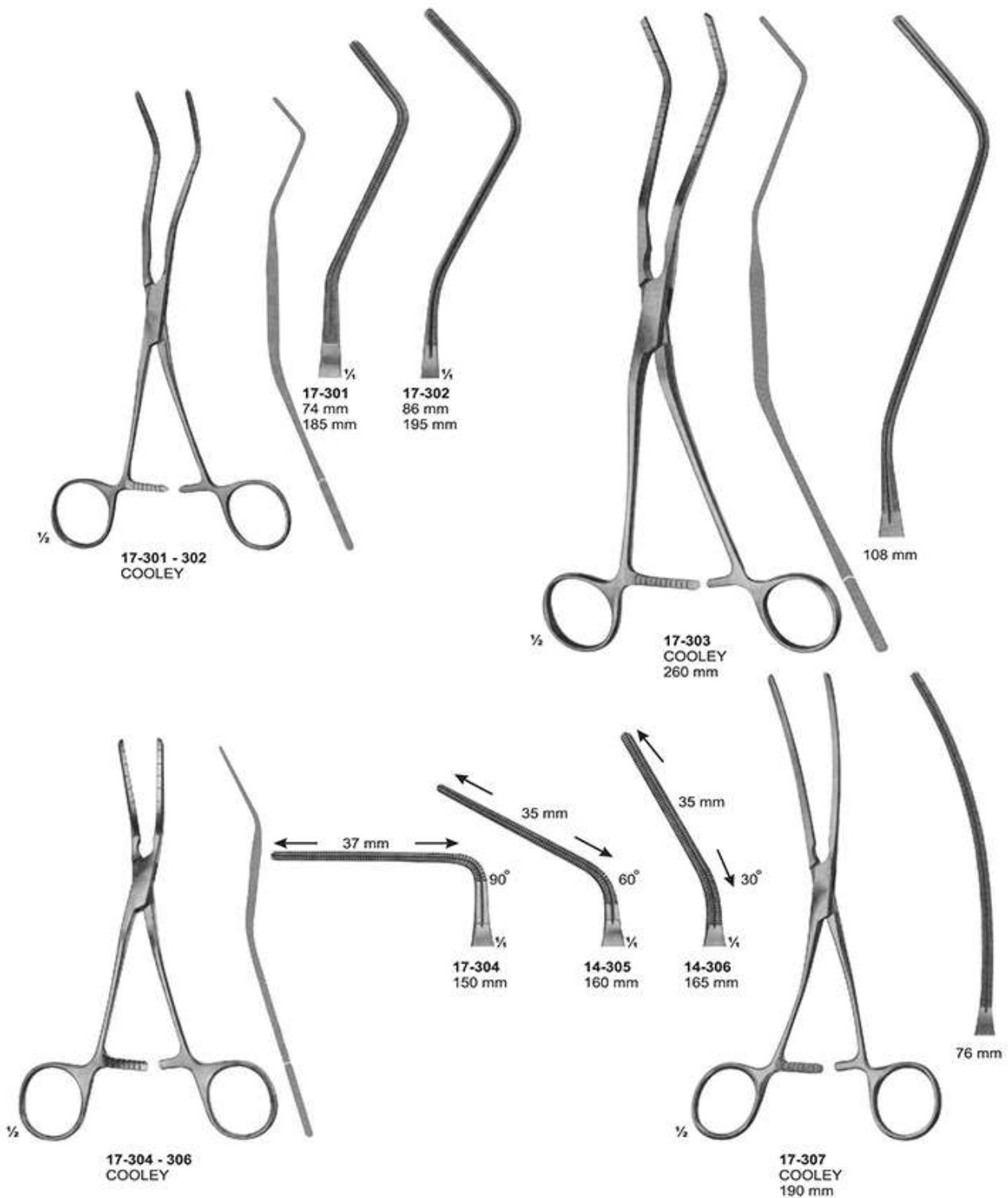

Aorta-Anastomosis Clamps

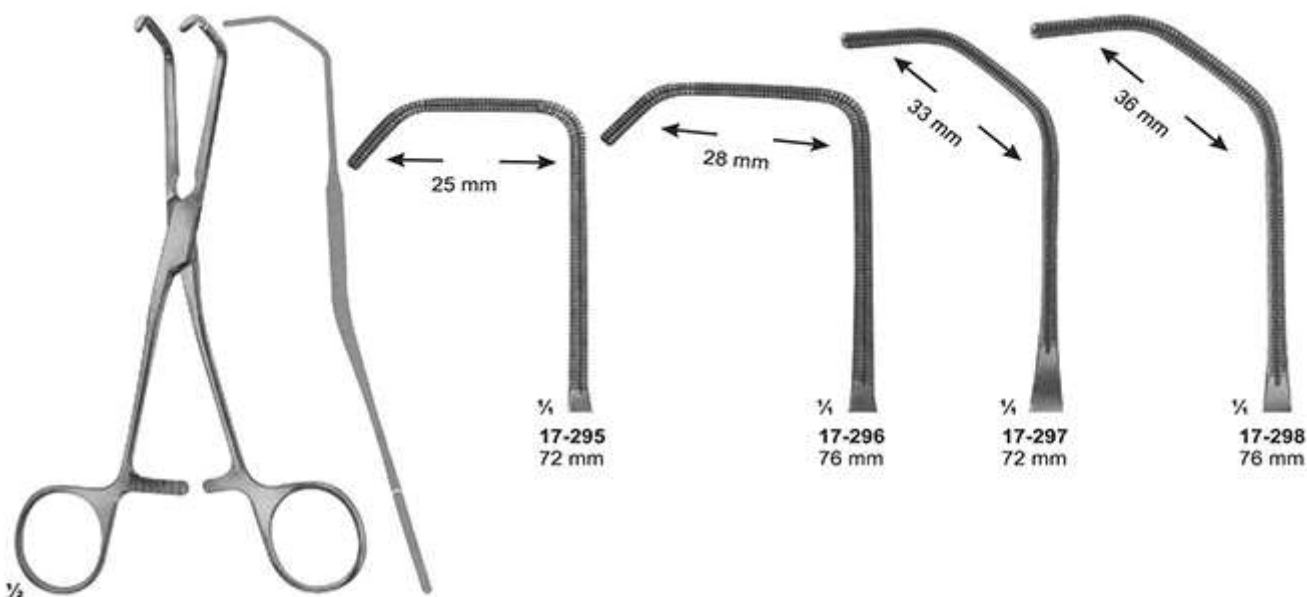

17-295 - 298
COOLEY
165 mm, 165 mm
175 mm, 180 mm

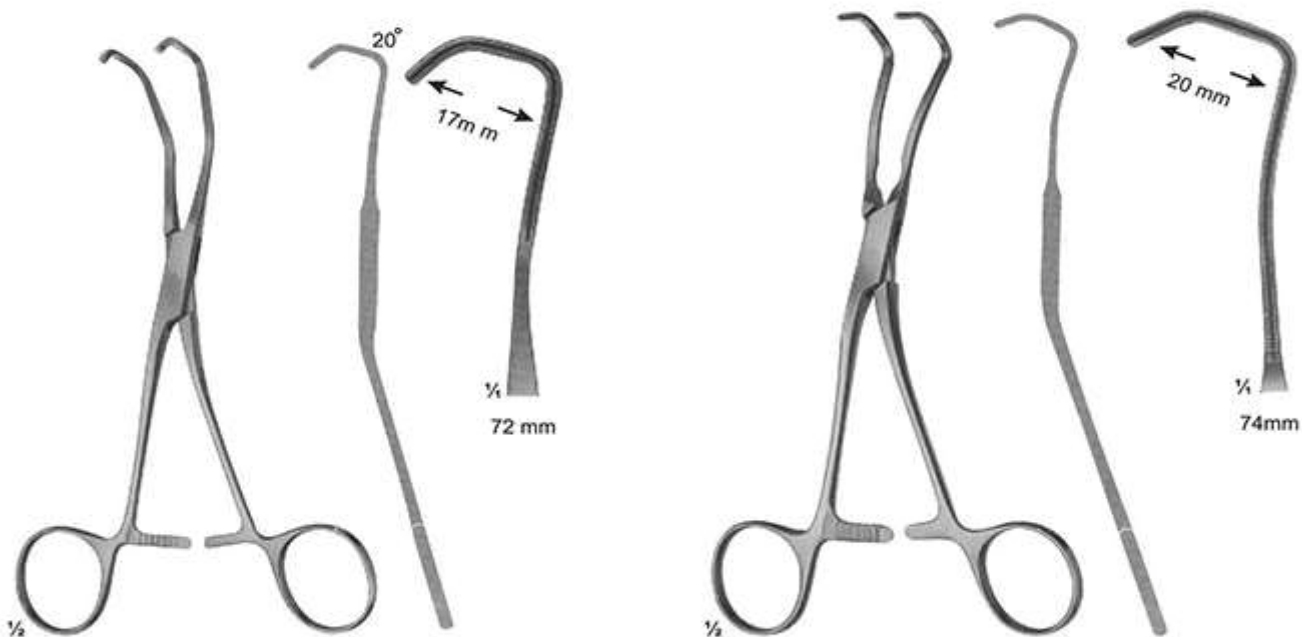

17-299
COOLEY
170 mm

17-300
COOLEY
175 mm

Aorta-Anastomosis Clamps

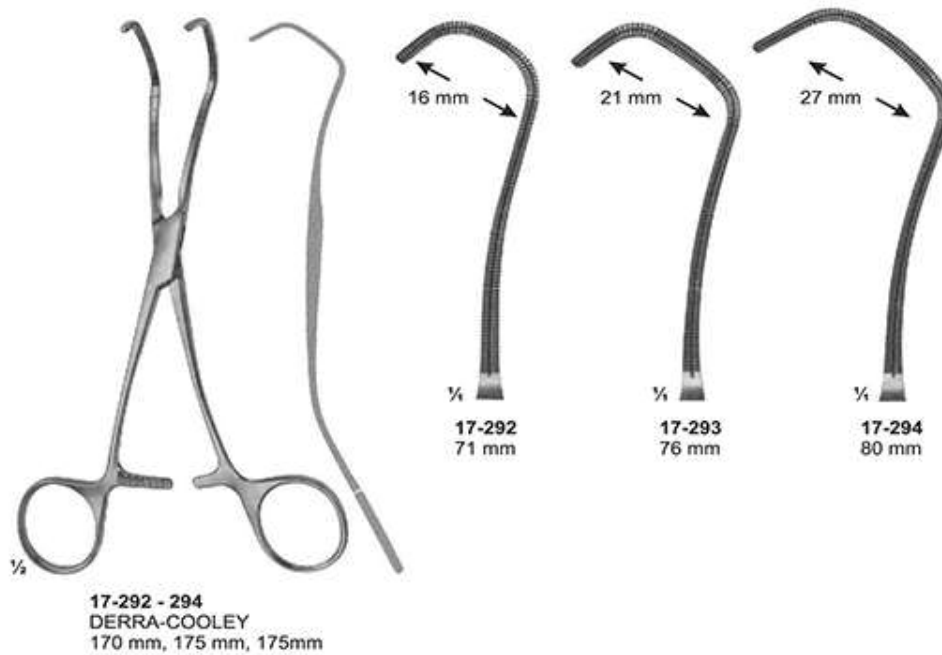
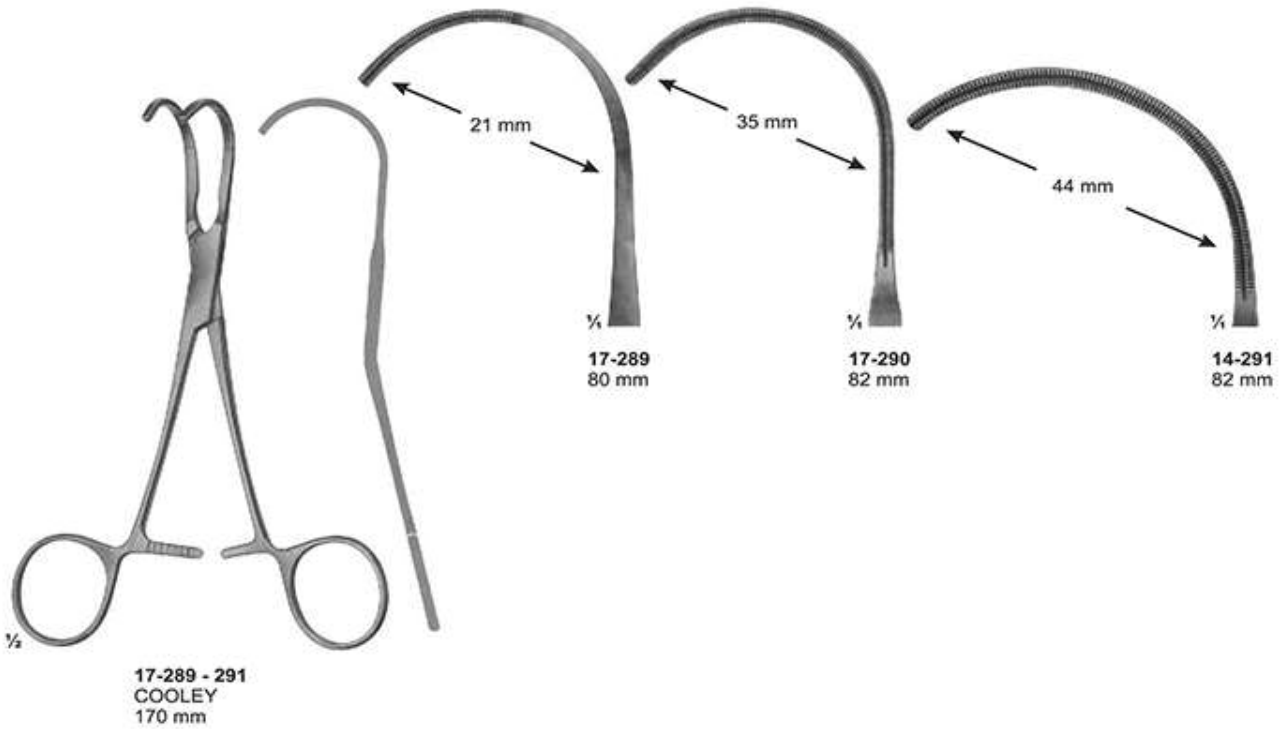

Aorta-Anastomosis Clamps

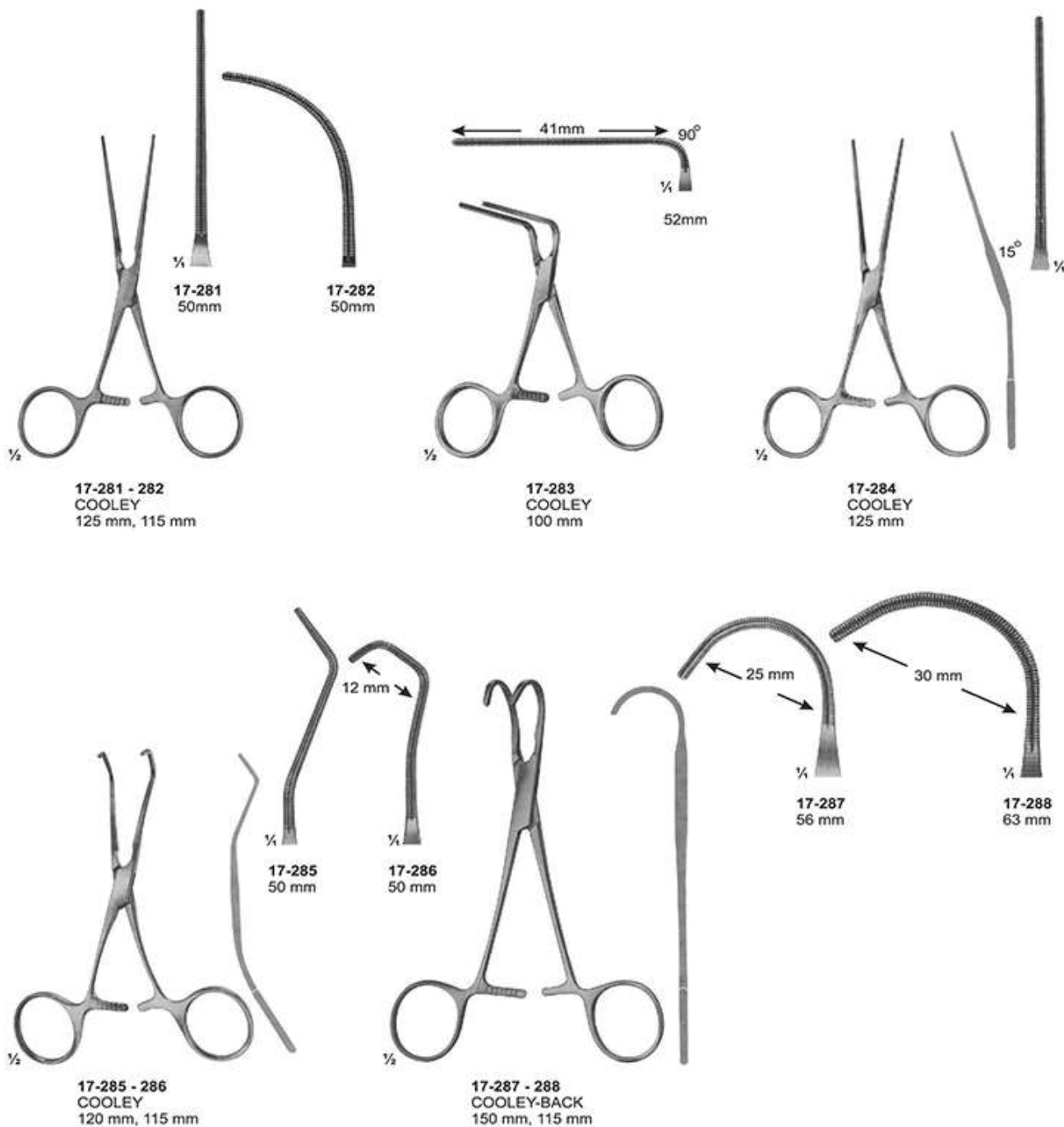

Aorta-Anastomosis Clamps

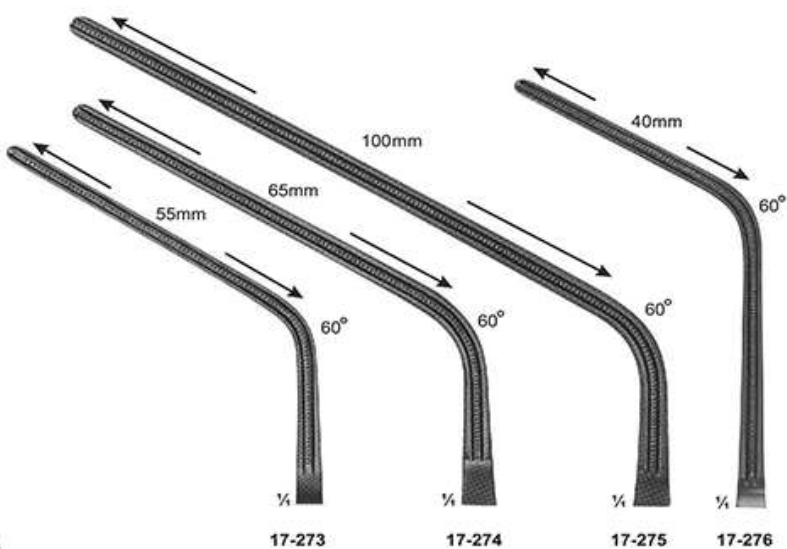

Total Length: 230 mm 280 mm 305 mm 240 mm
 Length of jaws: 85 mm 100 mm 135 mm 93 mm

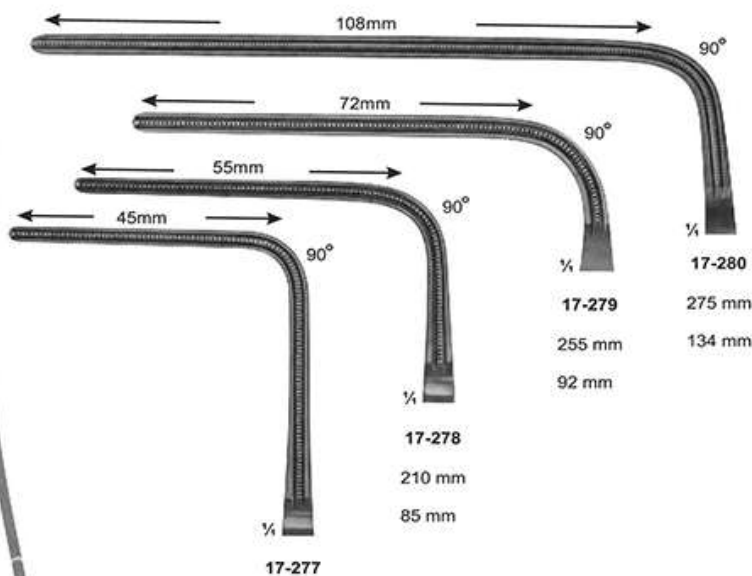

Total Length: 225 mm
 Length of jaws: 93 mm

Aorta-Anastomosis Clamps

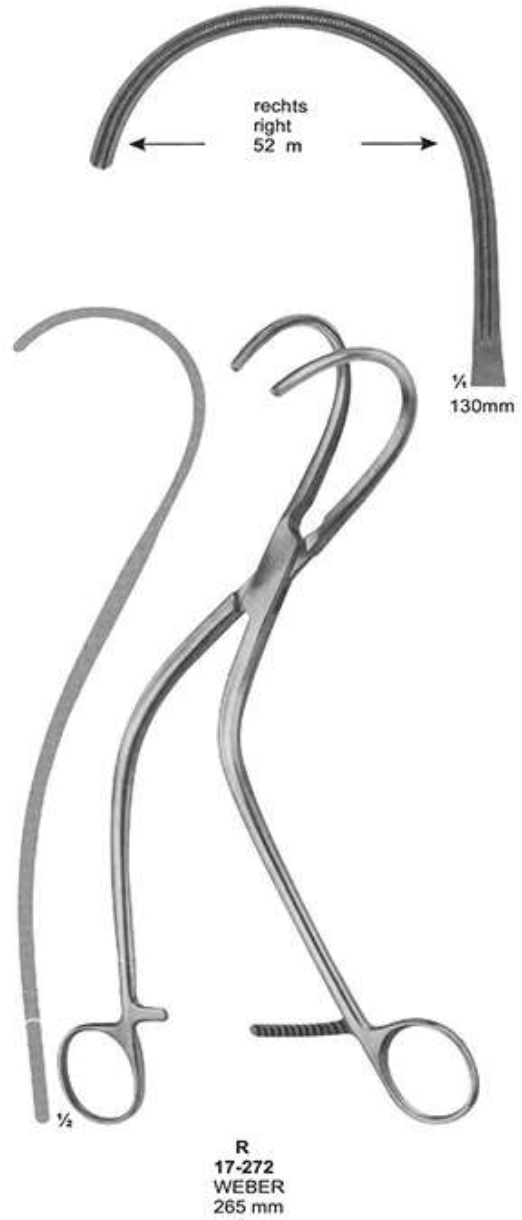
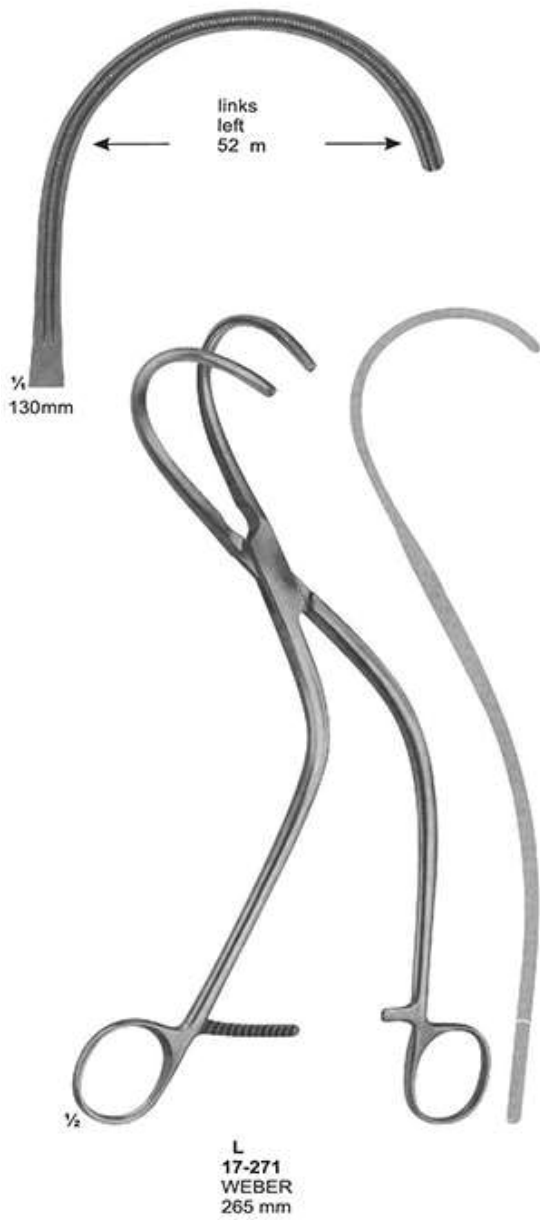

Vena-Cave Clamps

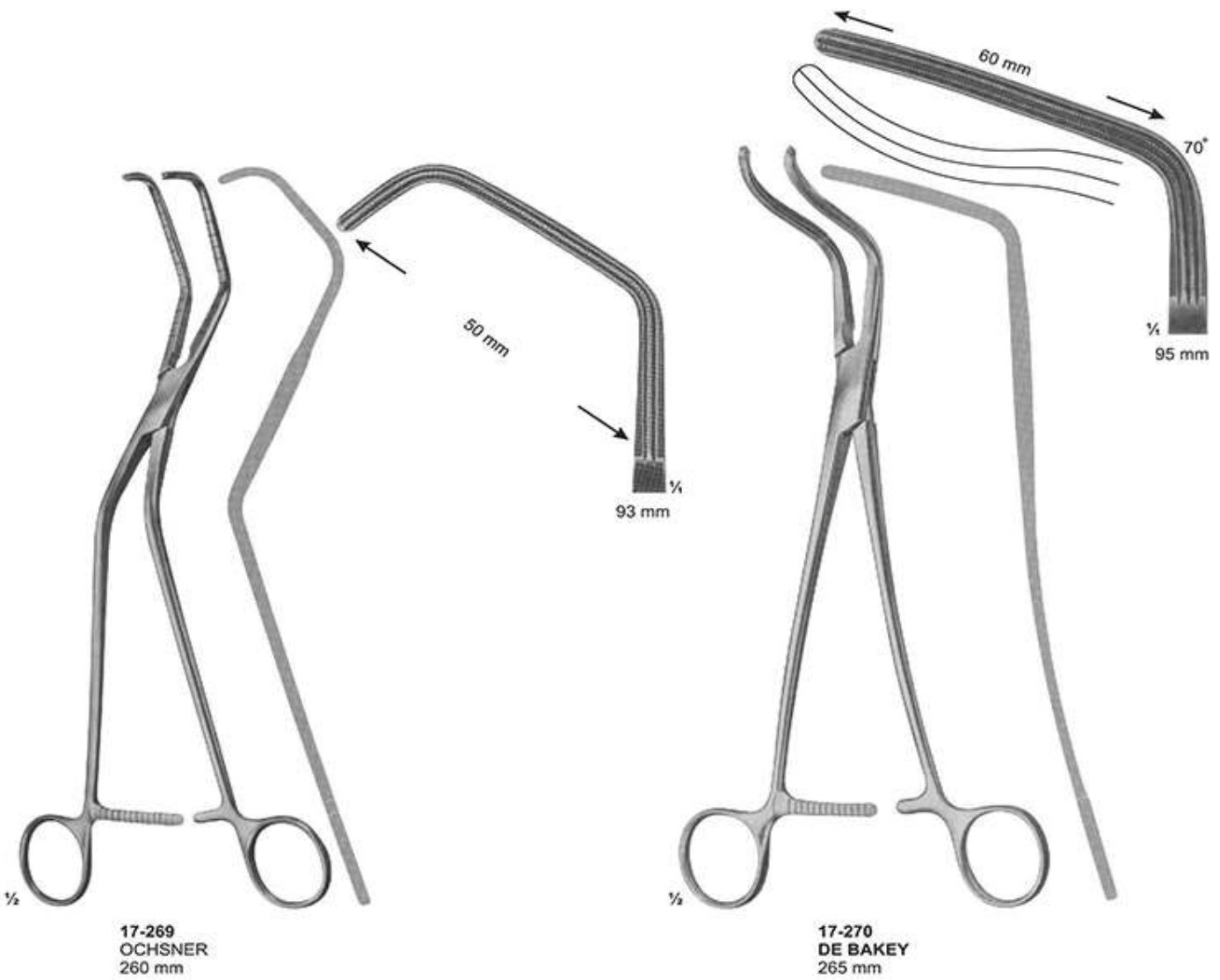

Vena-Cave Clamps

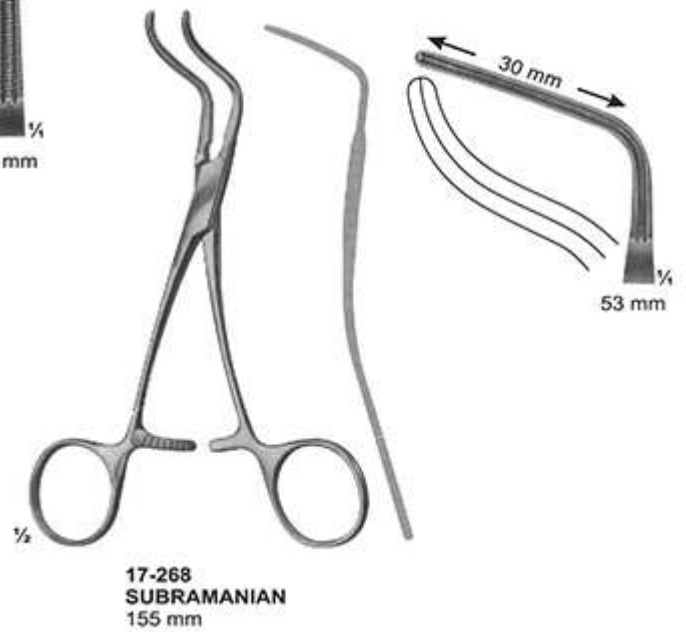
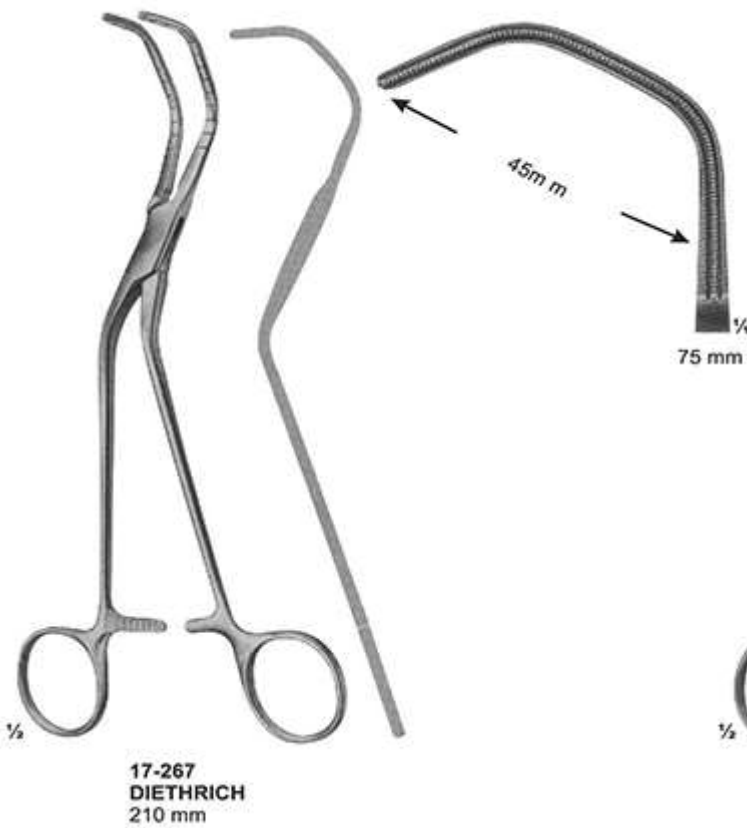

Vena-Cave Clamps

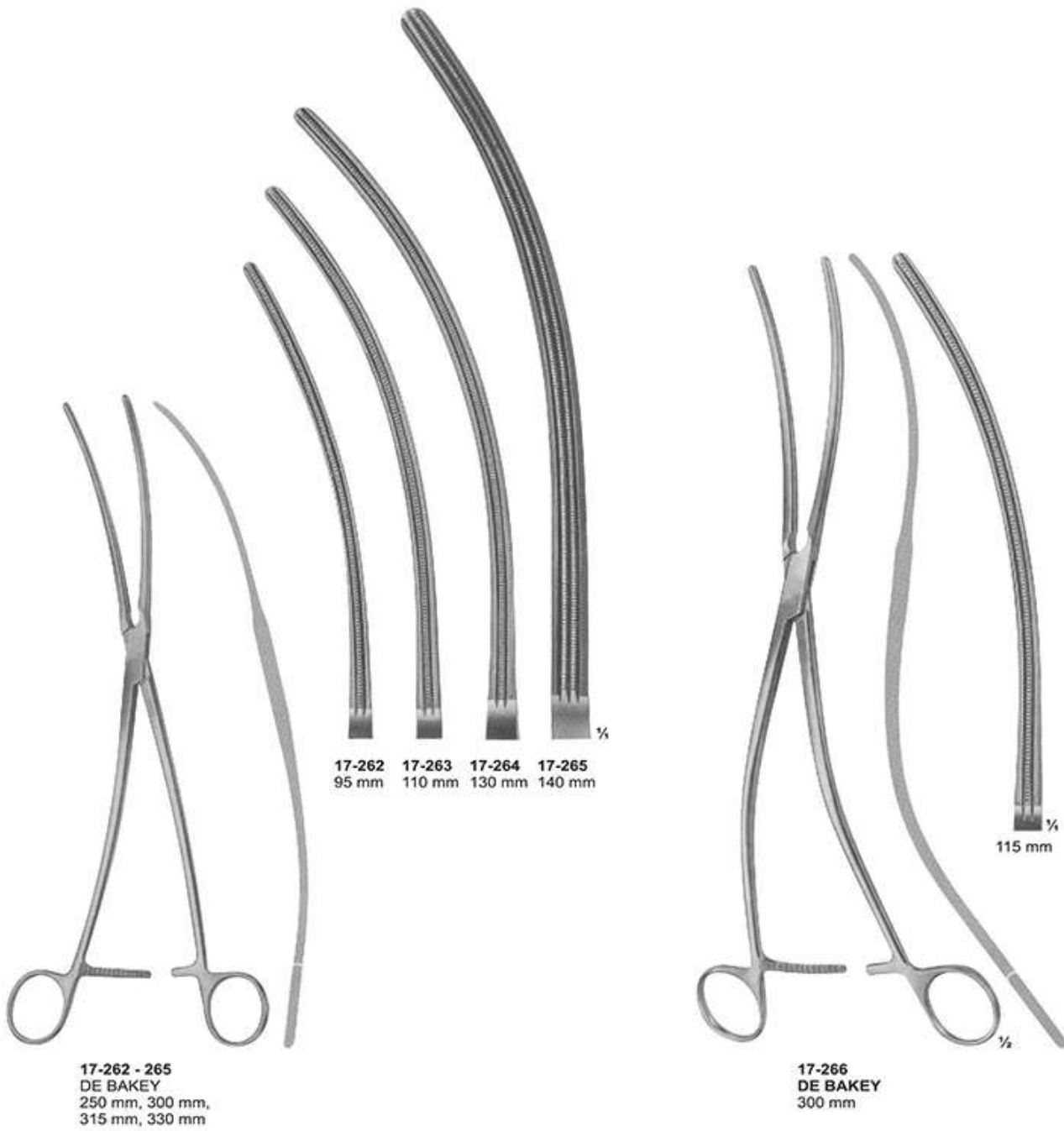

Vena-Cave Clamps

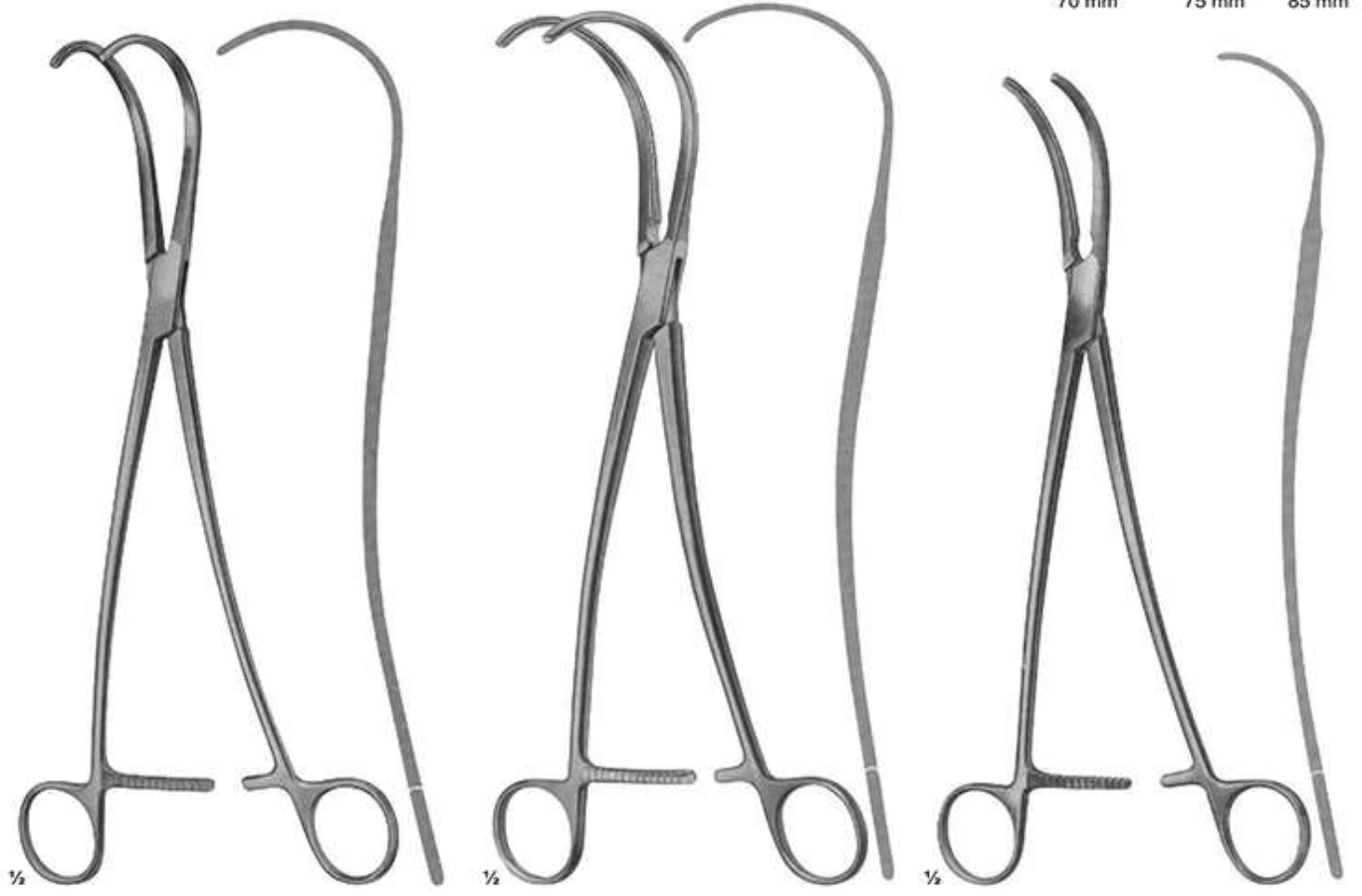
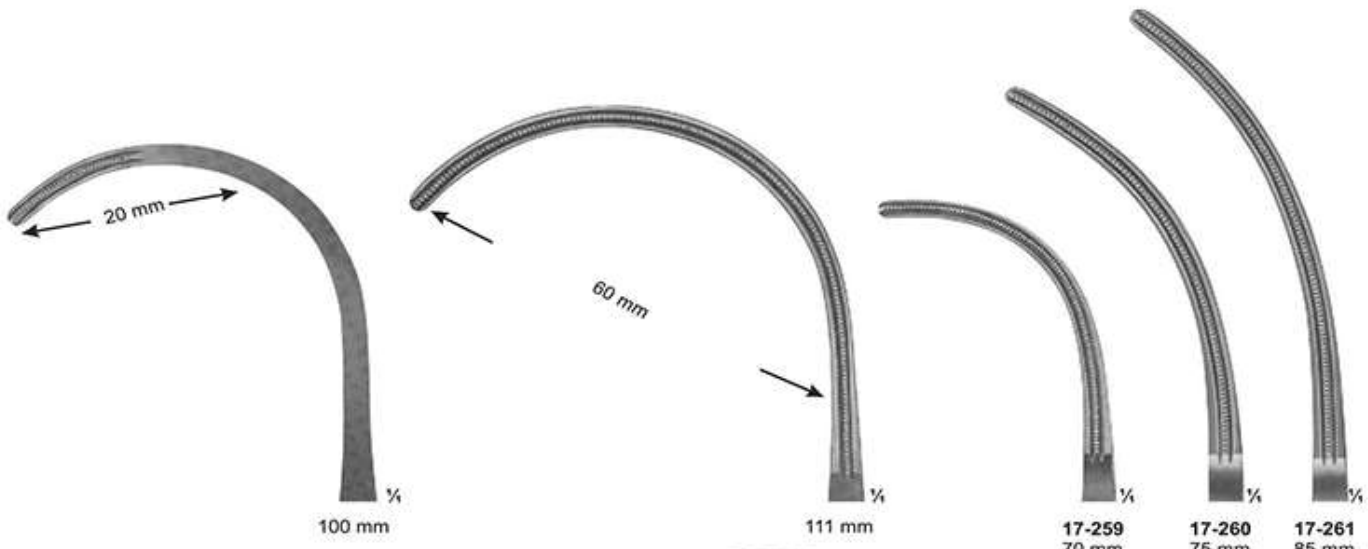

**17-257
DE BAKEY**
265 mm

**17-258
DE BAKEY**
270 mm

**17-259 - 261
DE BAKEY**
255 mm, 265 mm, 280 mm

Vena-Cave Clamps

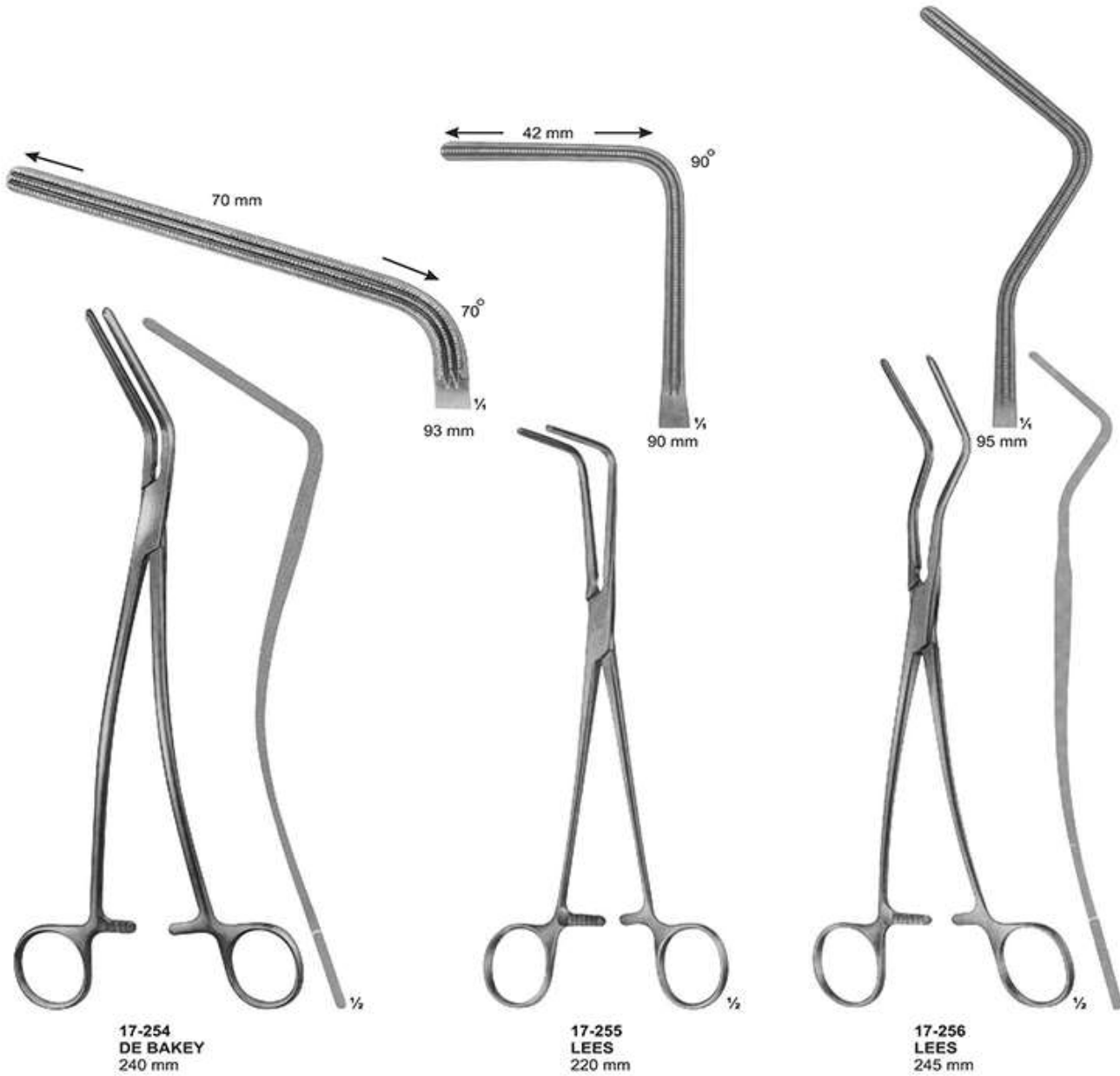

Vena-Cave Clamps

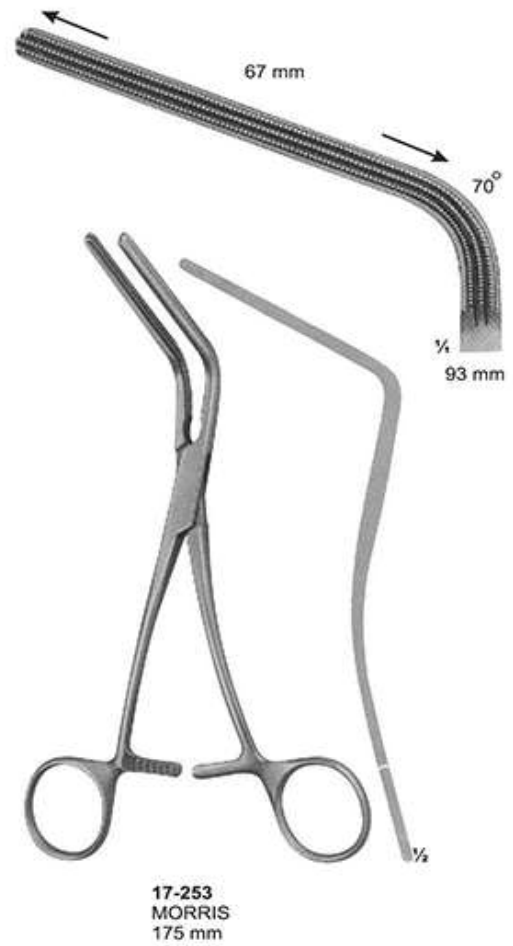
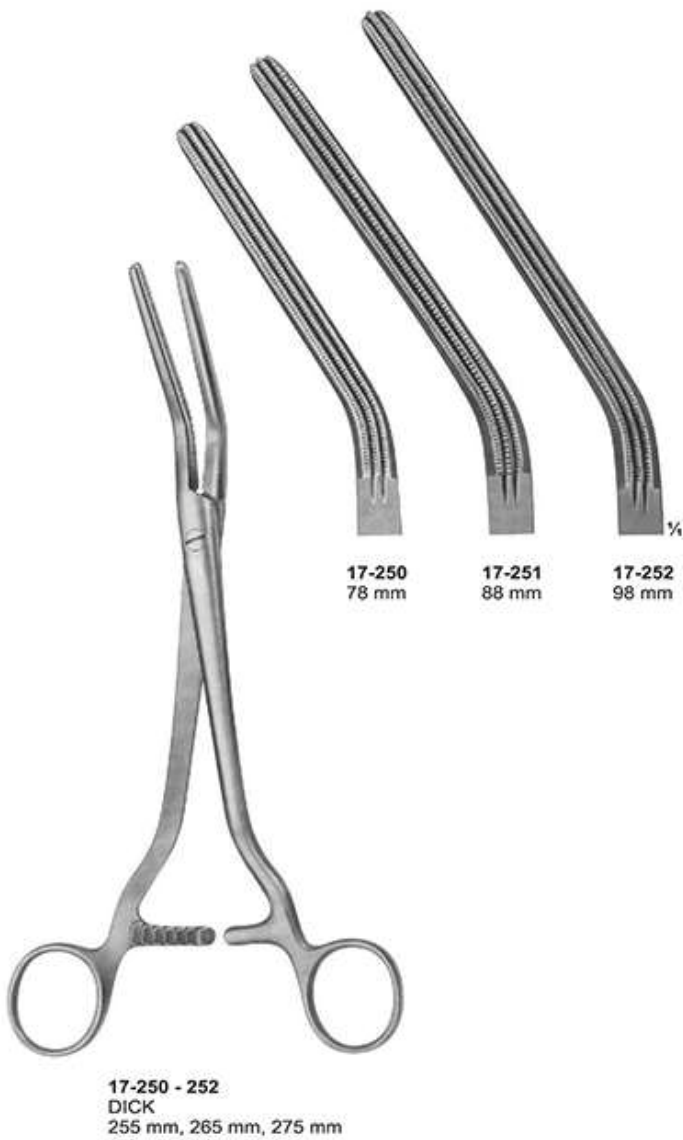

Vena-Cave Clamps



17-247
LELAND-JONES
195 mm



17-248
DE BAKAY
200 mm

Iliac clamp

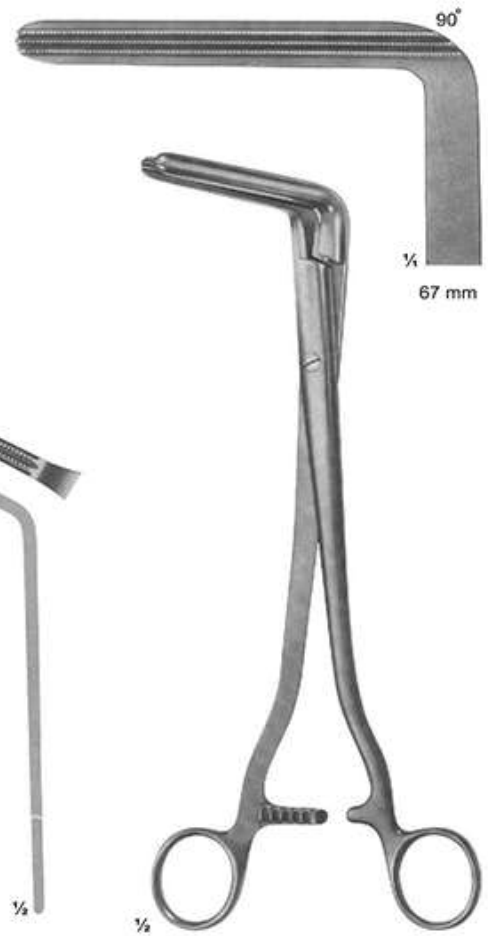

17-249
WERTHEIM
250 mm

Vena-Cave Clamps

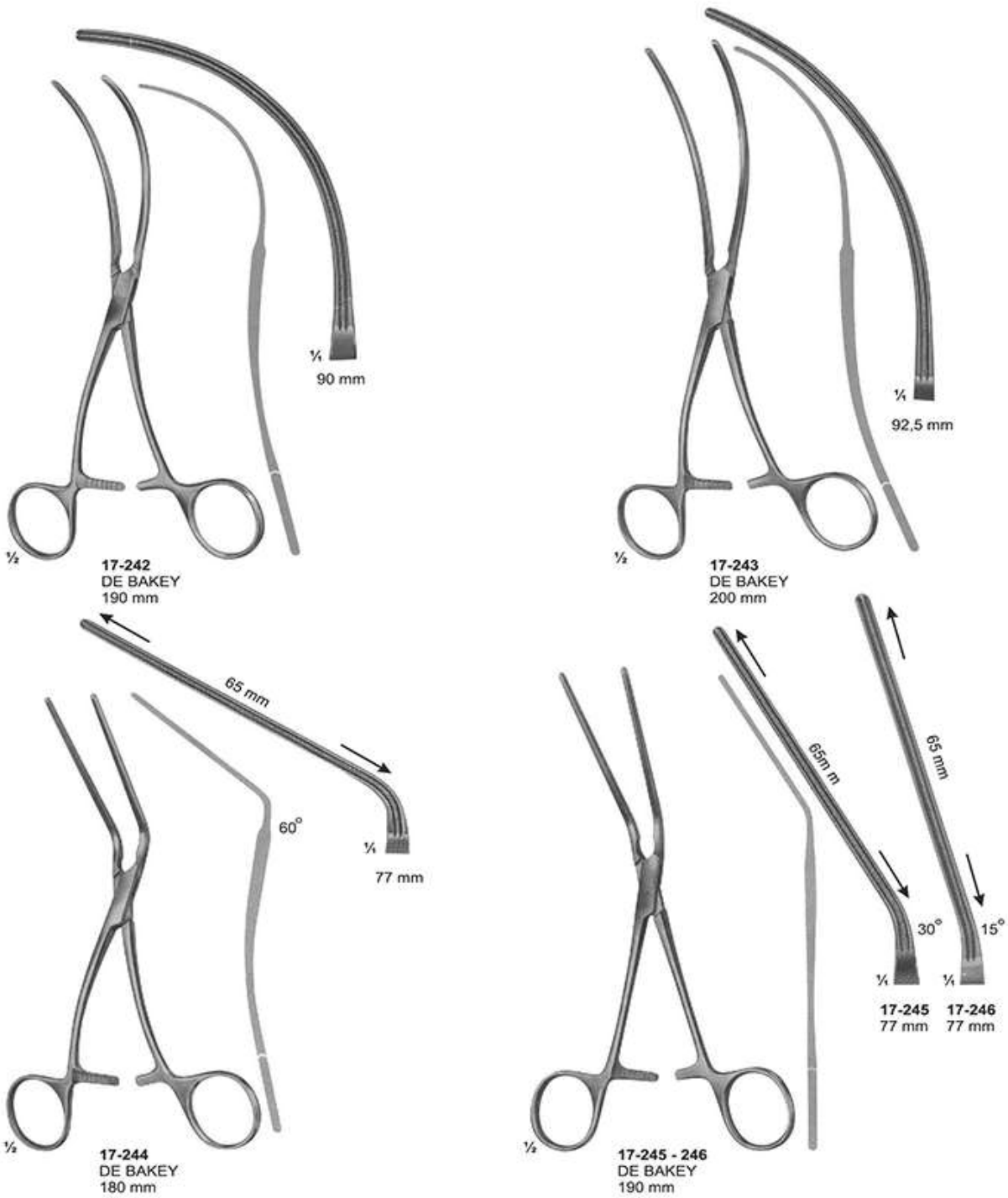

Vena-Cave Clamps

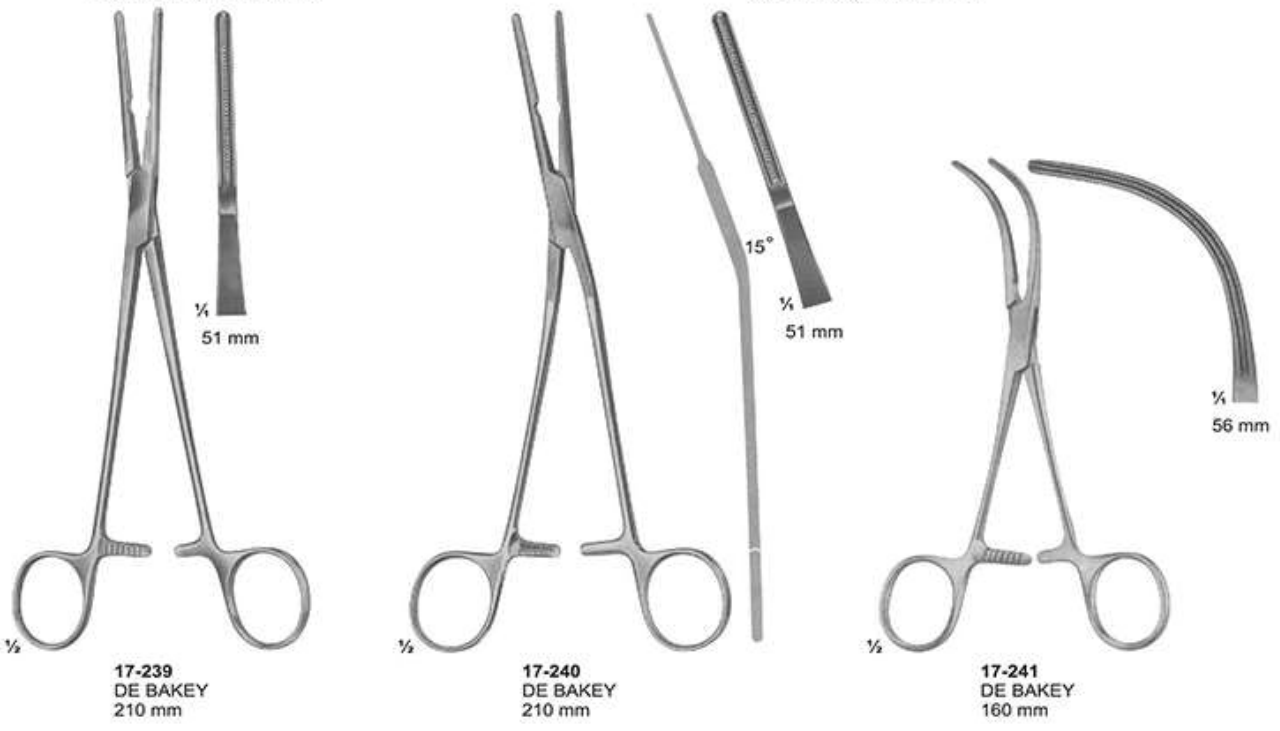
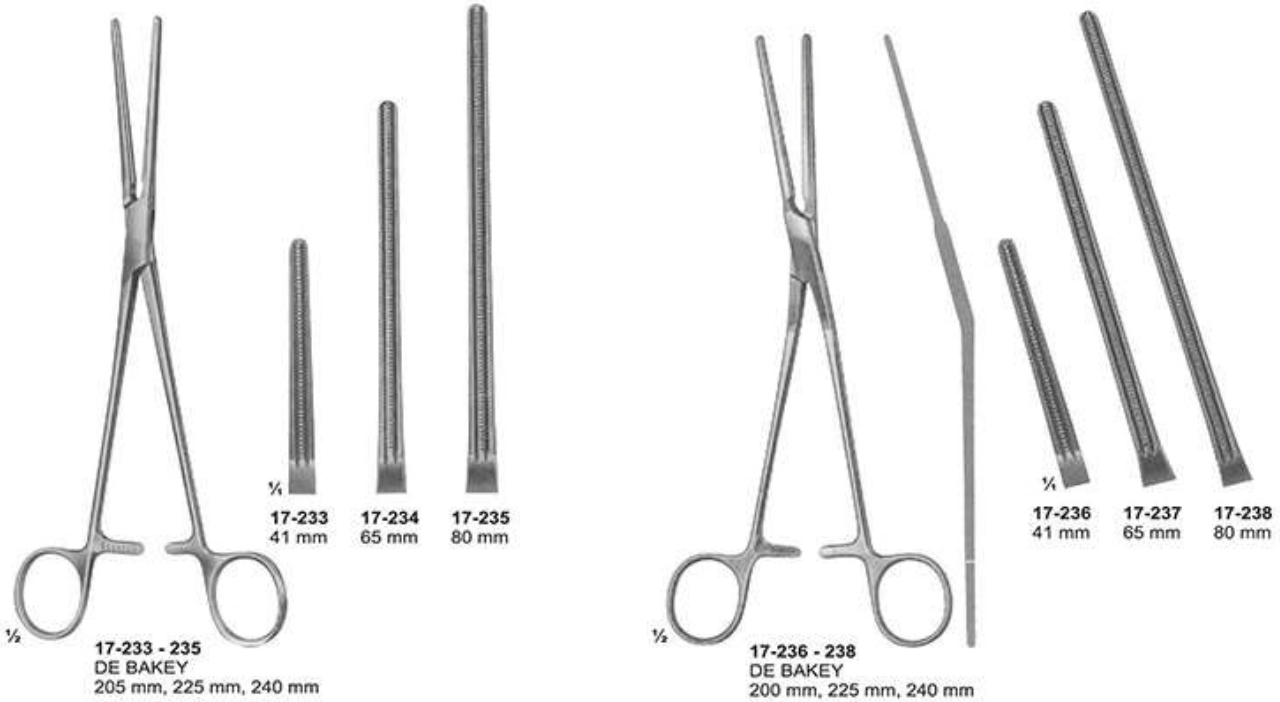

Vena-Cave Clamps

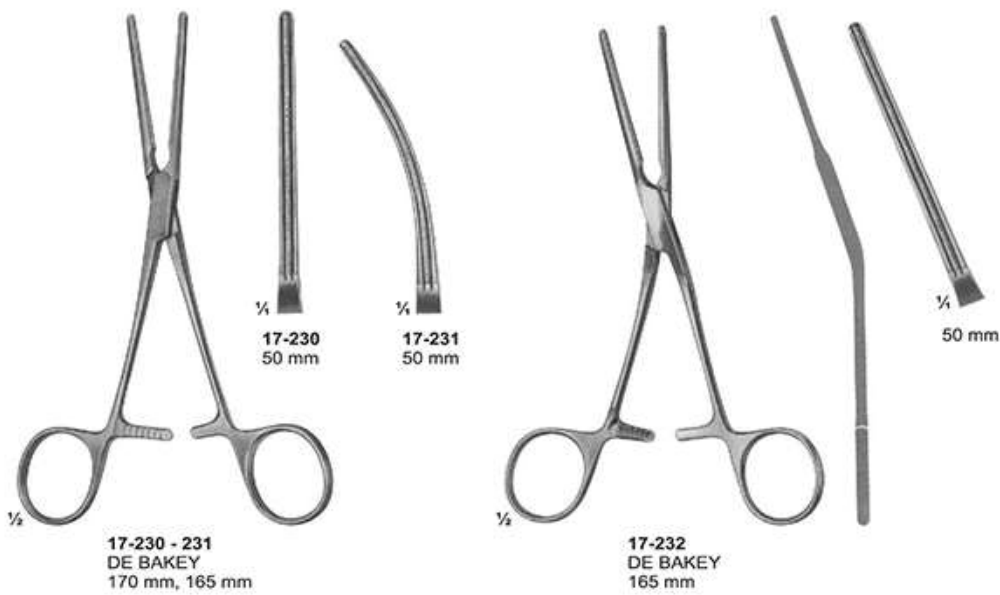
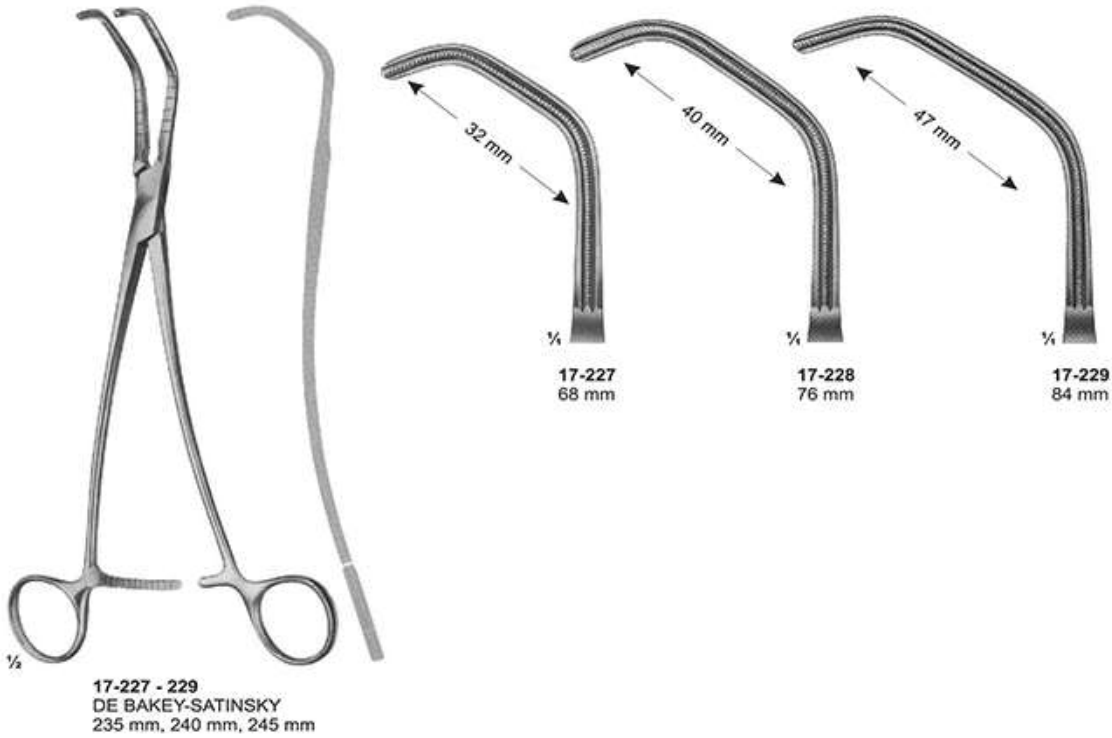

Vena-Cave Clamps

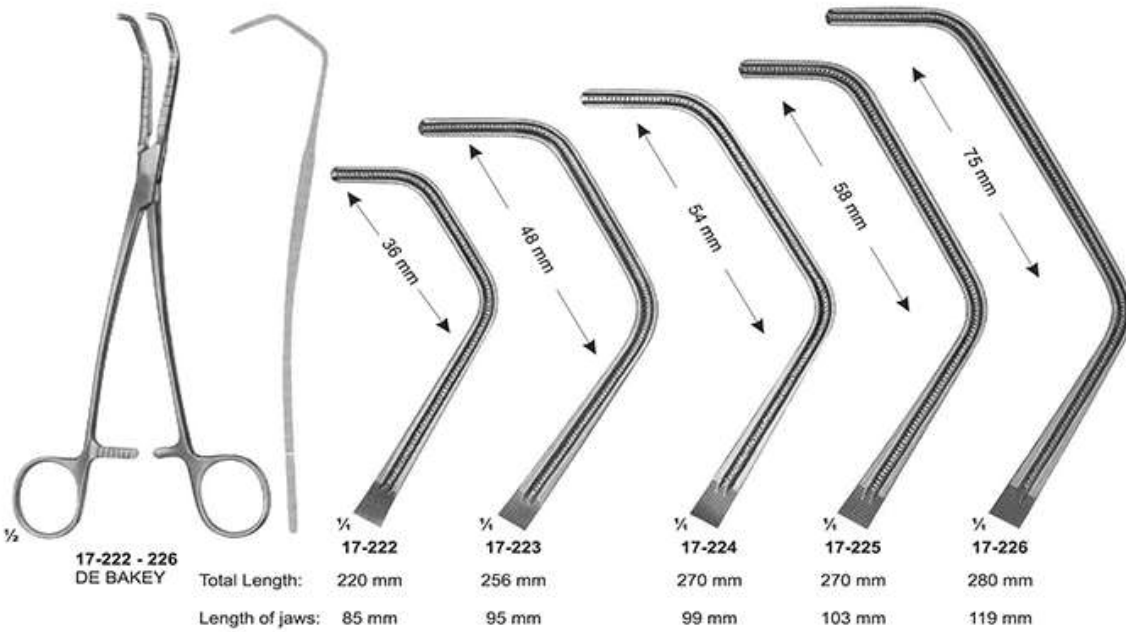
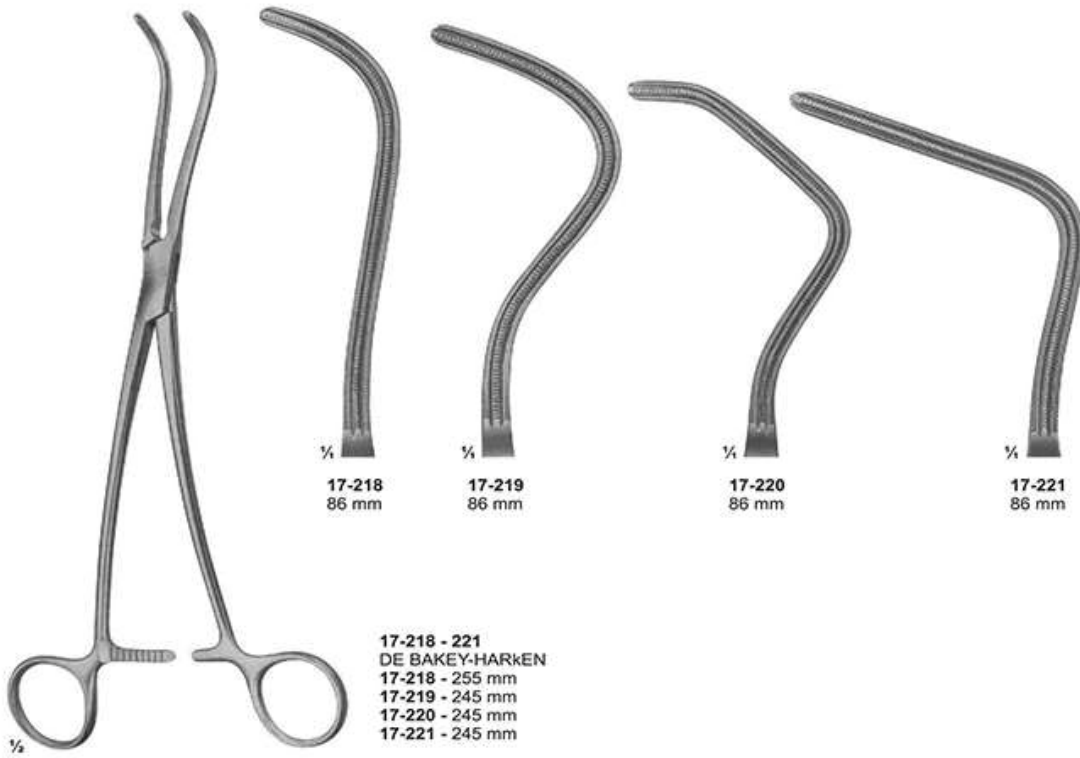

Vena-Cave Clamps

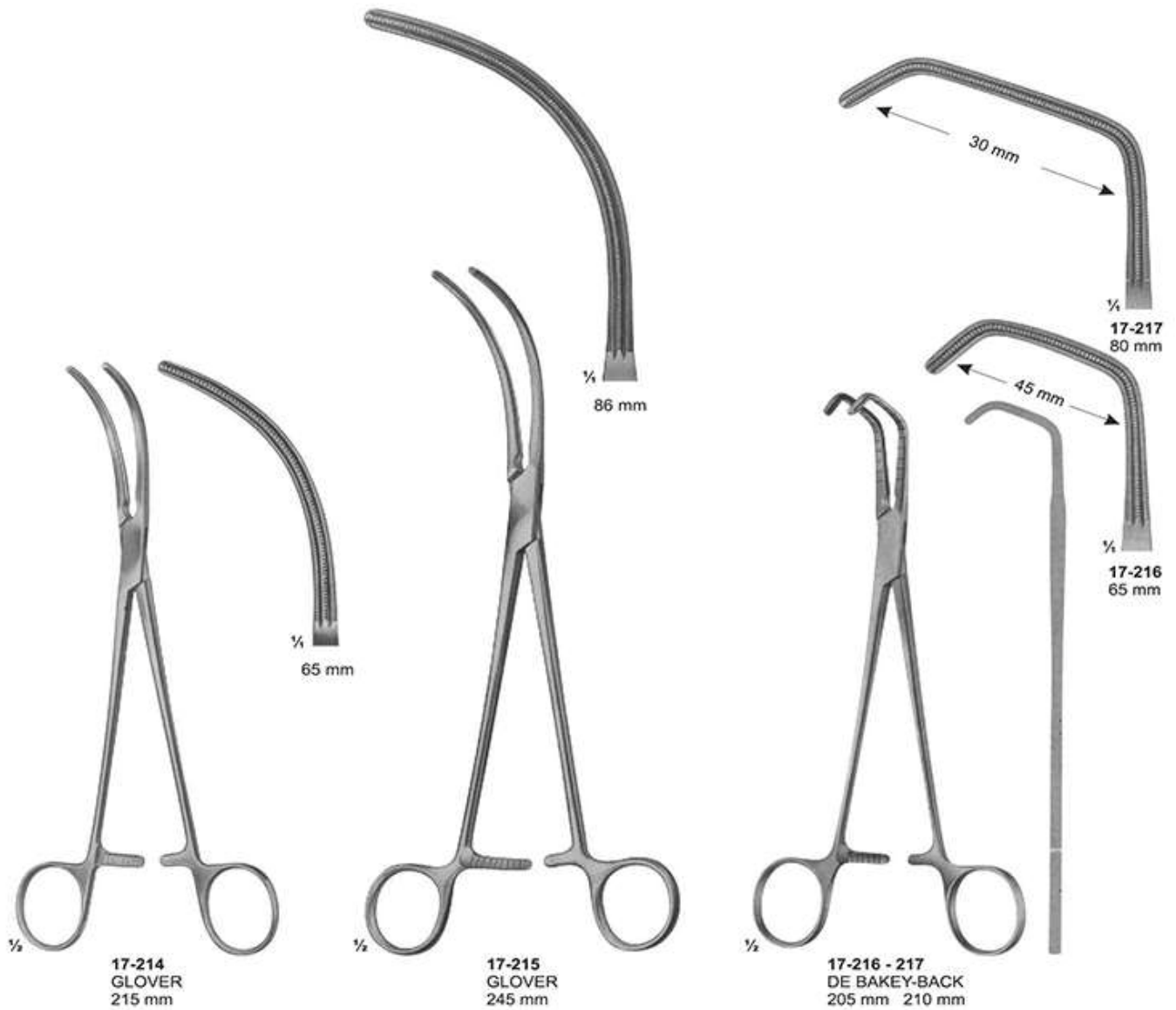

Anastomosis Clamps



17-210
DE-BAKEY-MIXTER
285 mm

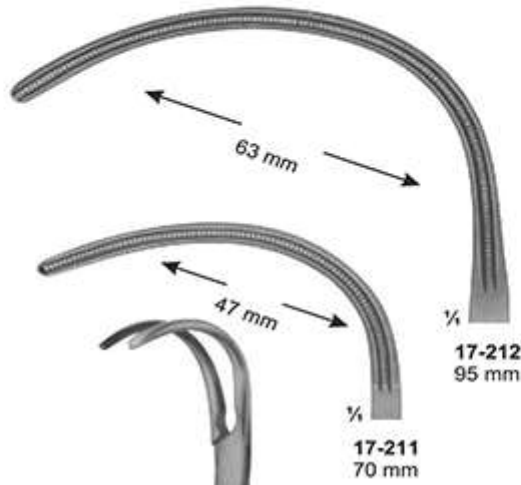

17-211
70 mm

17-212
95 mm

17-211 - 212

17-211 - 212
GLOVER
245 mm

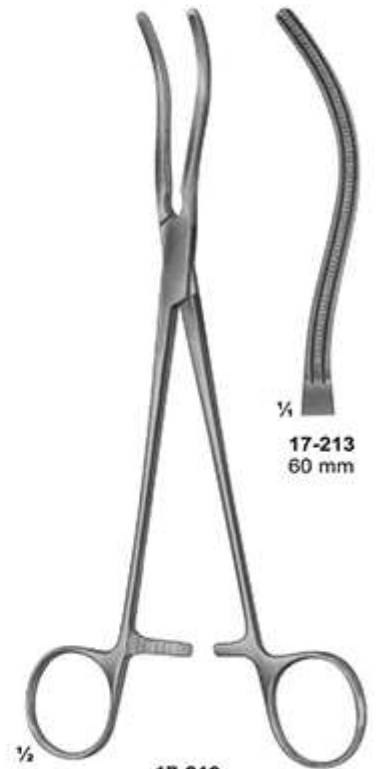

17-213
60 mm

17-213
GLOVER
220 mm

Non-traumatic Haemostatic Forceps



17-200 - 201
DE-BAKEY-KELLY
140 mm



17-202 - 203
PEAN
155 mm

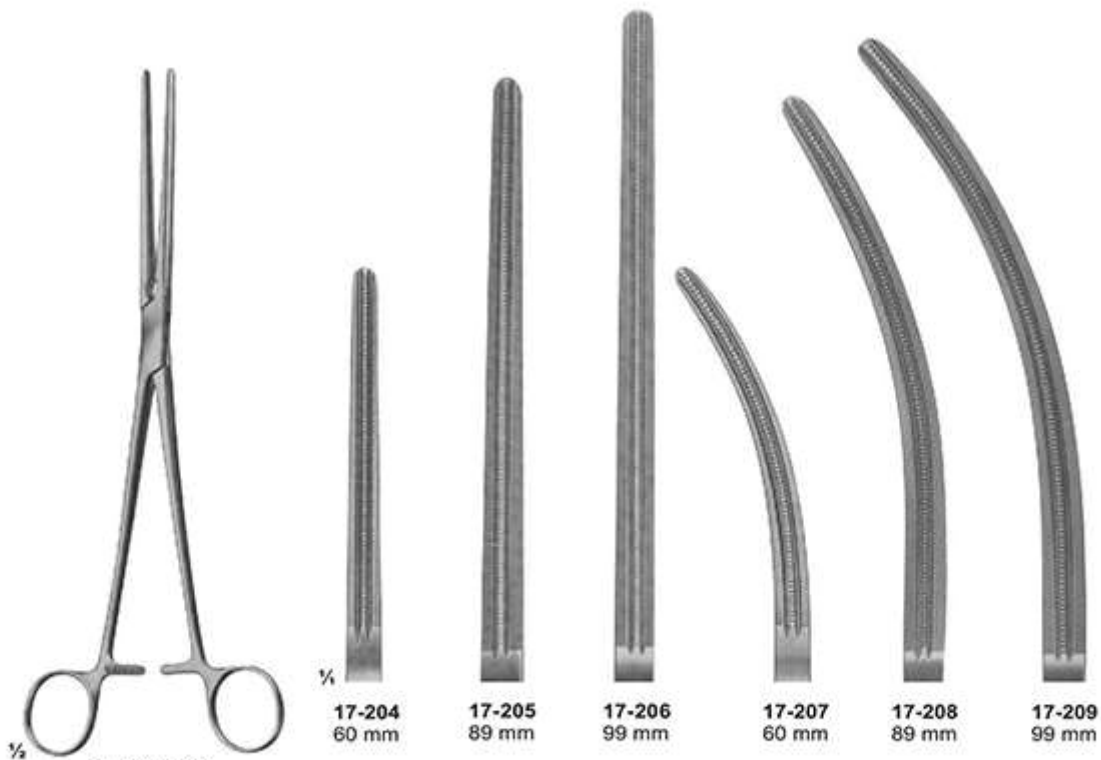

17-204 - 209
DE-BAKEY-PEAN **DE-BAKEY-PEAN**
17-204 200 mm 17-207 200 mm
17-205 265 mm 17-208 260 mm
17-206 280 mm 17-209 275 mm

Non-traumatic Haemostatic Forceps



17-192 - 193
125 mm



17-194 - 195
165 mm

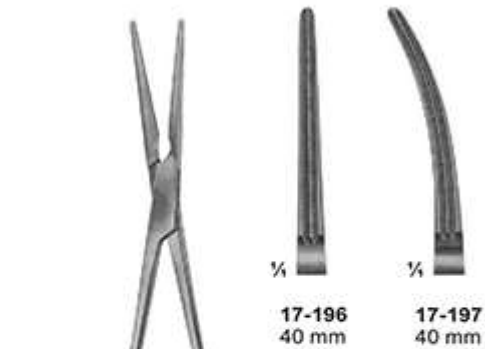

17-196 - 197
DE BAKEY-BAINRIDGE
155 mm

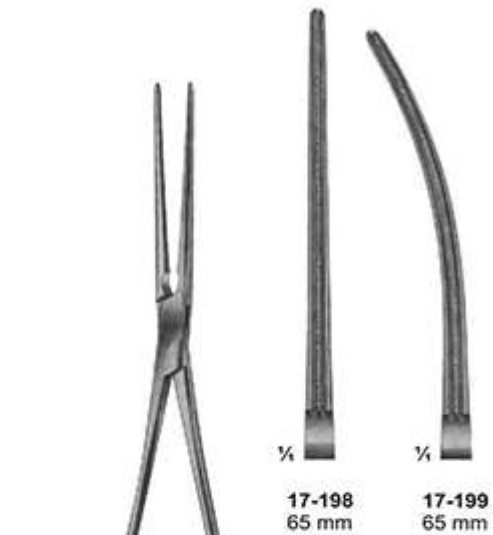

17-198 - 199
DE BAKEY-BAINRIDGE
180 mm

Anastomosis-and Multi-Purpose-Clamps-Pediatric types

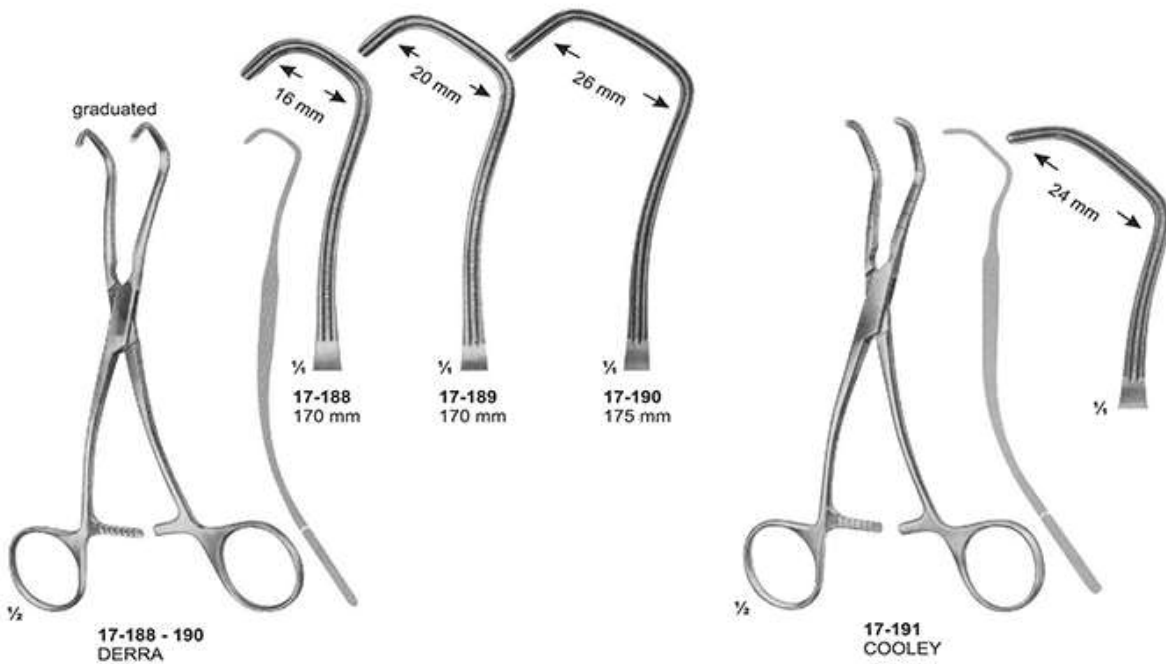
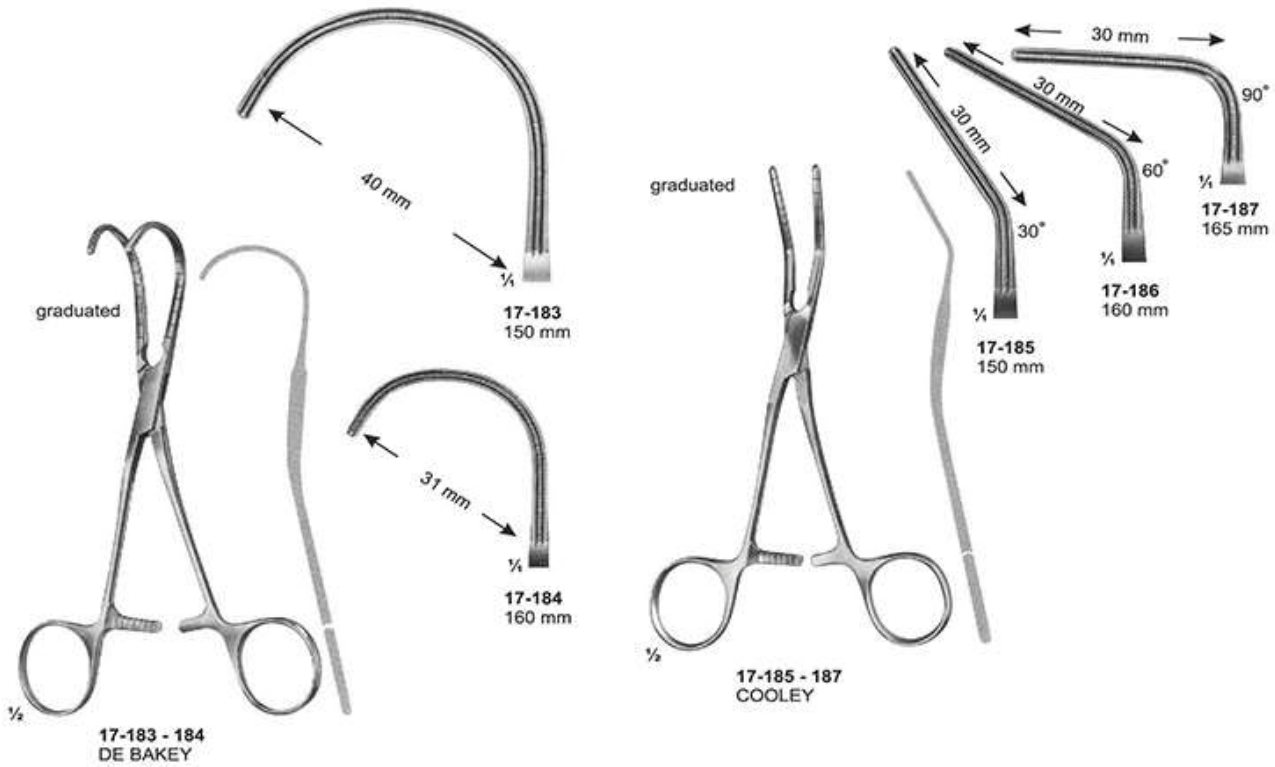

Anastomosis-and Multi-Purpose-Clamps for Neonatales

graduated



17-175 - 178
CASTANESA

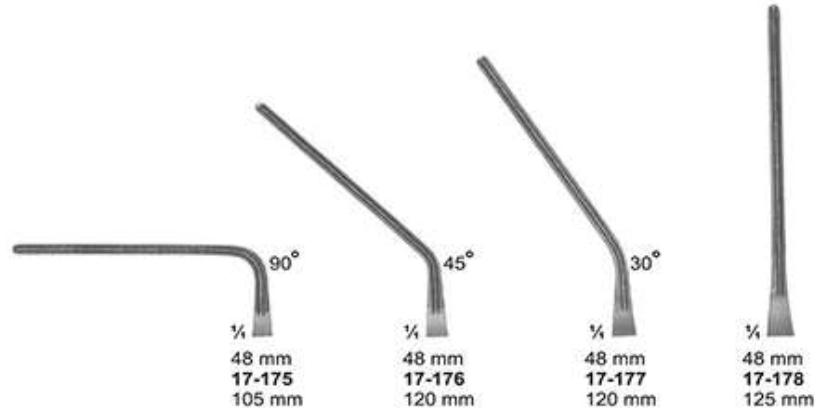

graduated



17-179 - 182
CASTANESA

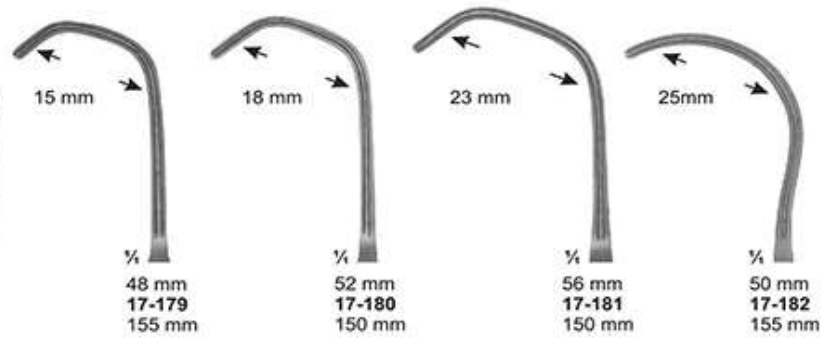

Ring Handle Bulldog Clamps

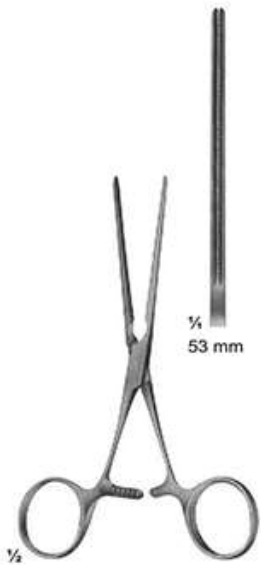

17-170
DE-BAKEY
gerade straight
130 mm

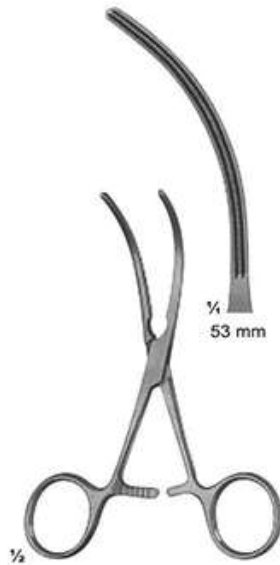

17-171
DE-BAKEY
Maul gebogen
curved jaws
125 mm

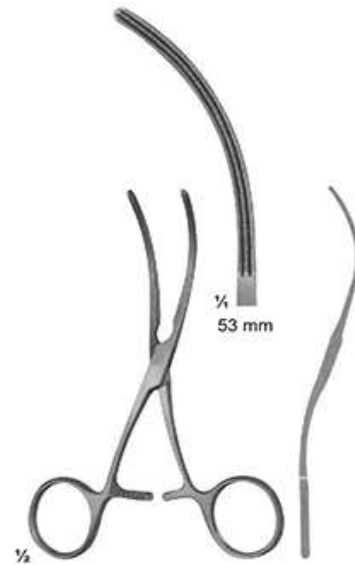

17-172
DE-BAKEY
S-shaped curved
125 mm

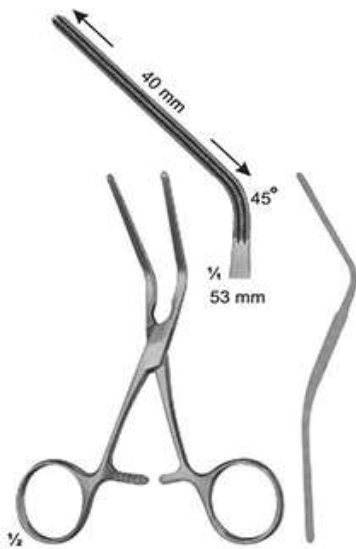

17-173
DE-BAKEY
45° winklig gebogen
angled 45°
125 mm

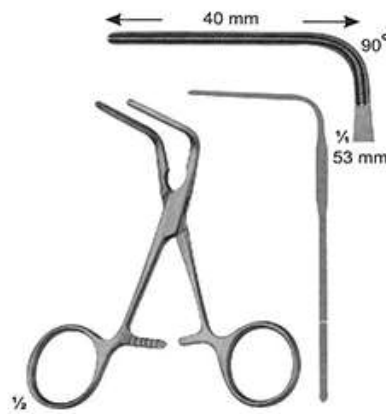

17-174
DE-BAKEY
90° winklig gebogen
angled 90°
105 mm

Ultra-Light-Forceps

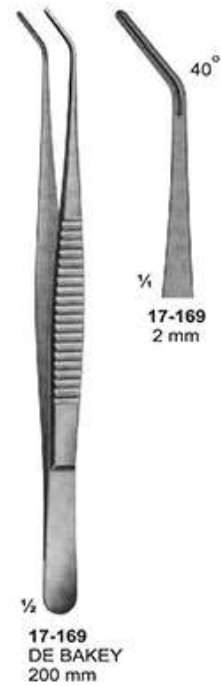
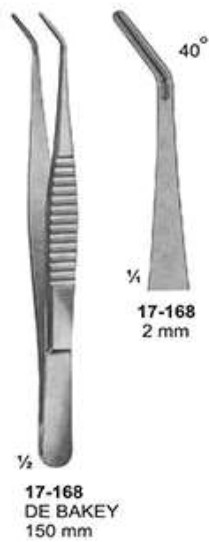
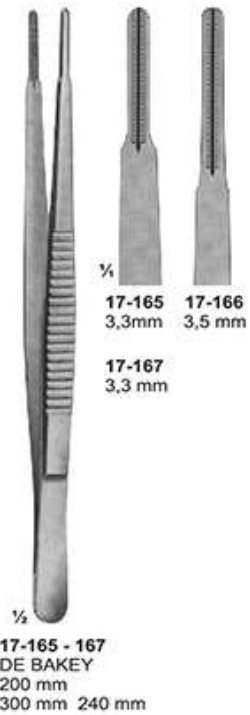
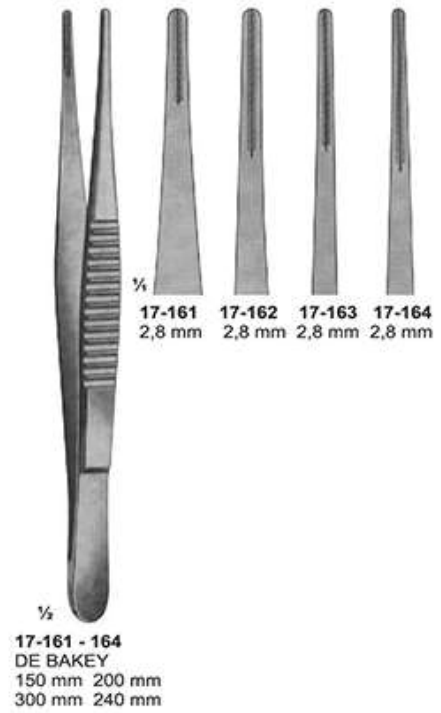
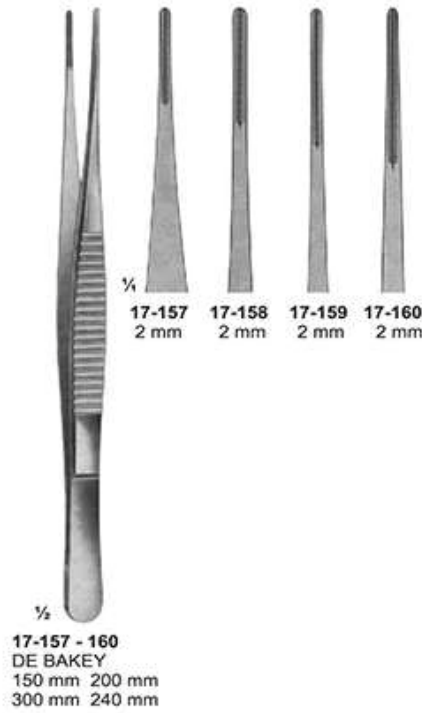
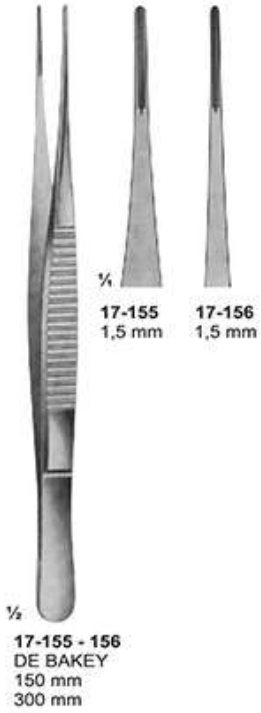

Ultra-Light-Forceps

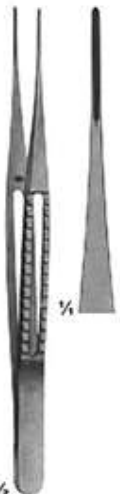

17-151
Width of jaws
1,5 mm
Length
150mm



17-152
1,5 mm
200 mm



17-153
1,5 mm
240 mm



17-154
1,5 mm
300 mm

Biopotome and Aortic Dilators

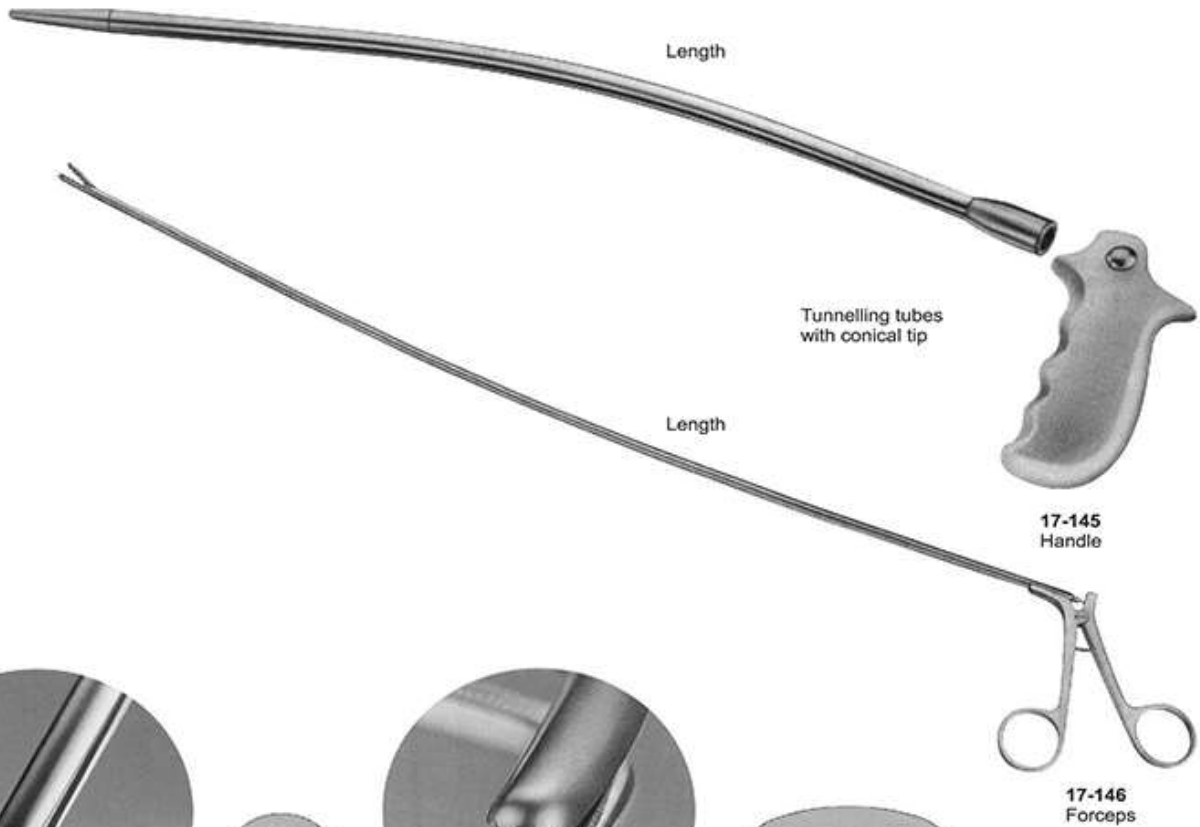

DE BAKKEY
17-147
1 : 2 rows of teeth

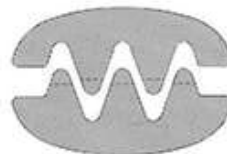

DE BAKKEY
17-148
2 : 3 rows of teeth



COOLEY
17-149
2 : 2 rows of teeth

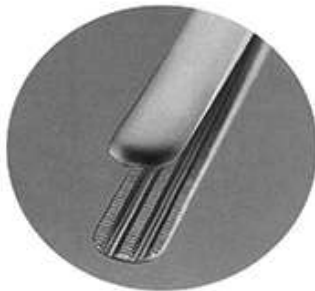

DARDIK
17-150
2 : 3 rows of teeth

Biopotome and Aortic Dilators

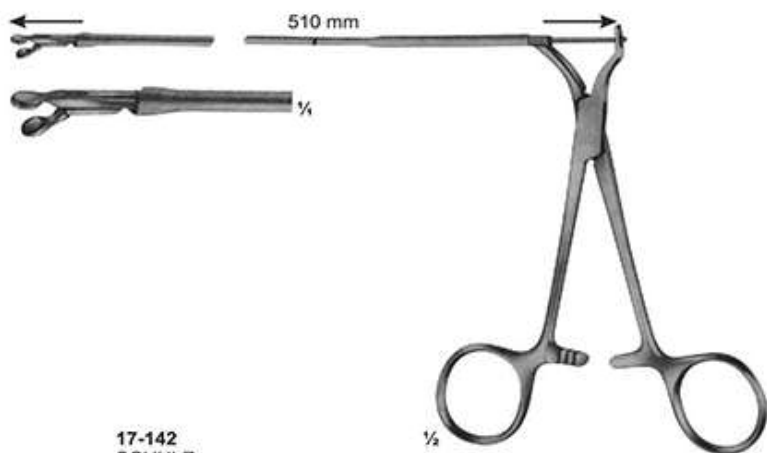

**17-142
SCHULZ**
Biopotome, mit flexiblem Schaft, 510 mm lang,
with round jaws 3 mm diam.

Biopsy forceps, for biopsy from the right atrium
through cava juglaris, prior to heart implantations.

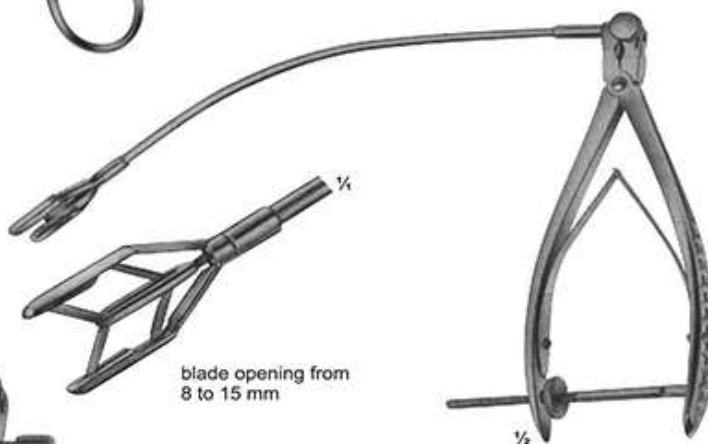

**17-144
COOLEY**
Dilator for
mitral valve
for children

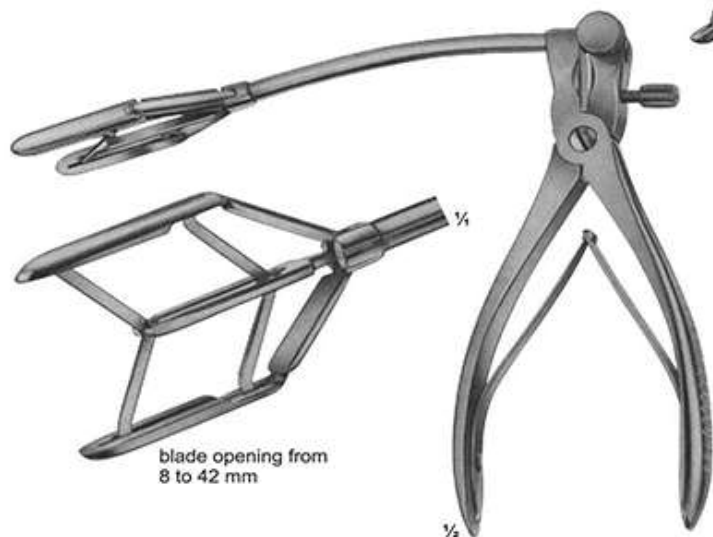

**17-143
TUBBS**
Dilator for
mitral valve

blade opening from
8 to 42 mm

blade opening from
8 to 15 mm

Irrigating Cannulae, Embolus Grasping Forceps, Dilators

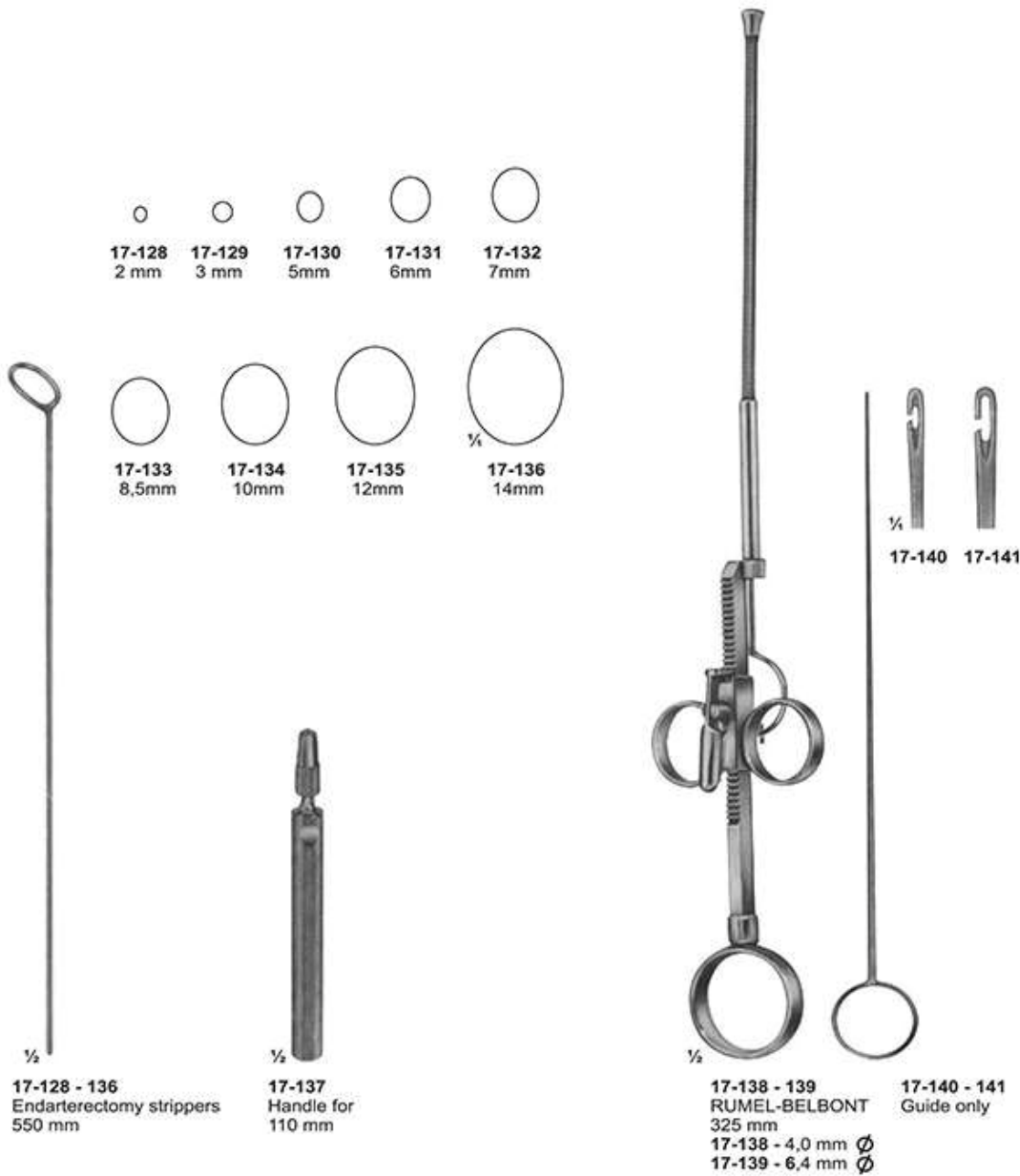

Irrigating Cannulae, Embolus Grasping Forceps, Dilators

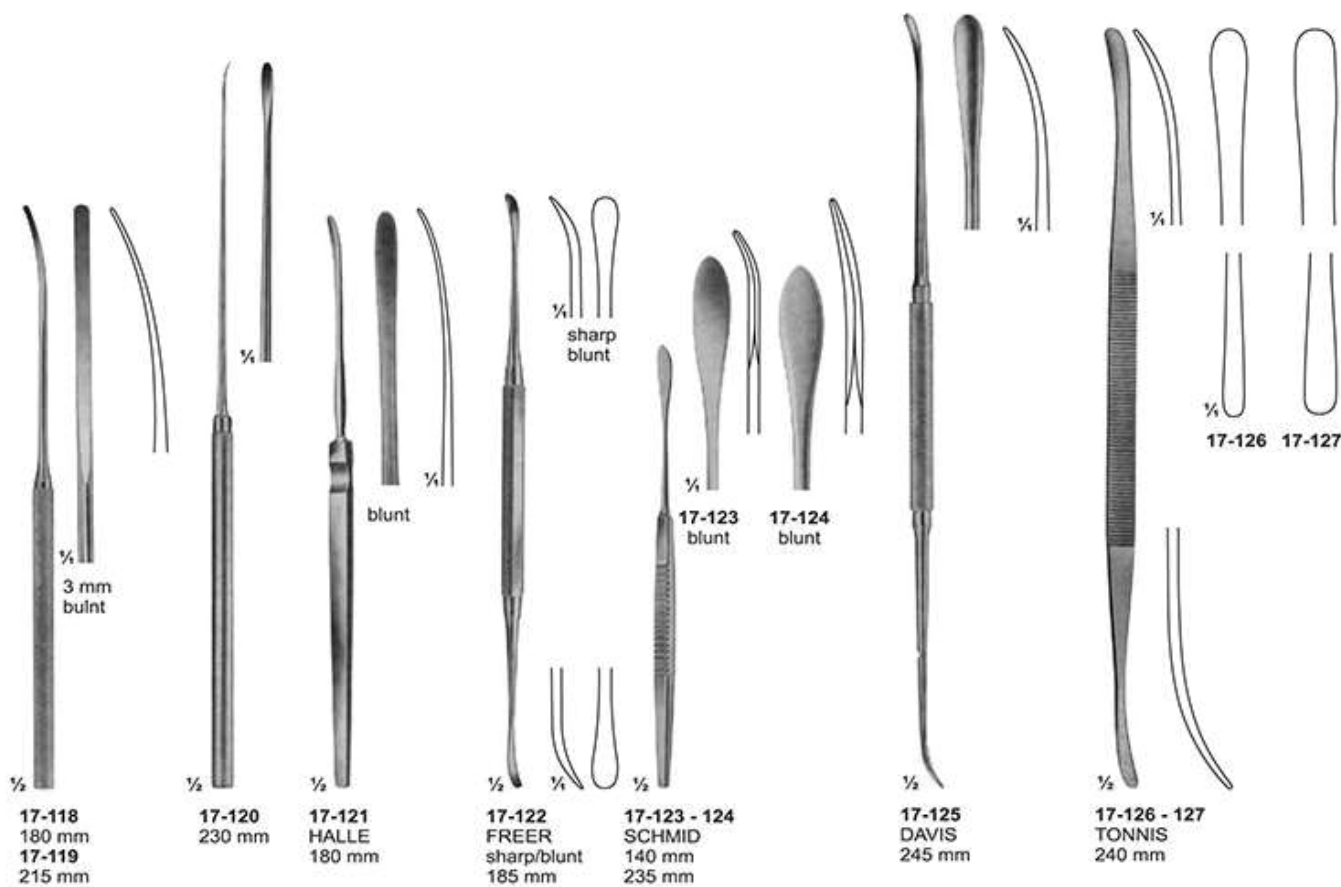

Irrigating Cannulae, Embolus Grasping Forceps, Dilators

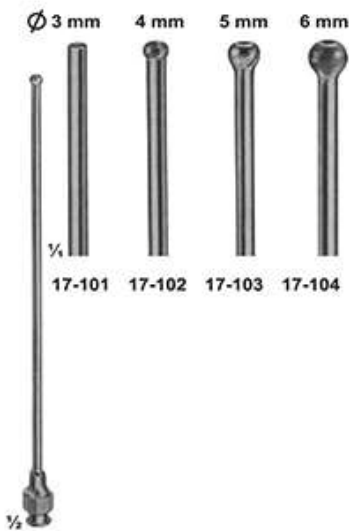

17-101 - 104
SCHMID
Vessel irrigating cannulae,
malleable, silver plated
150 mm



17-105
BLAKE
Embolus grasping
forceps
205 mm

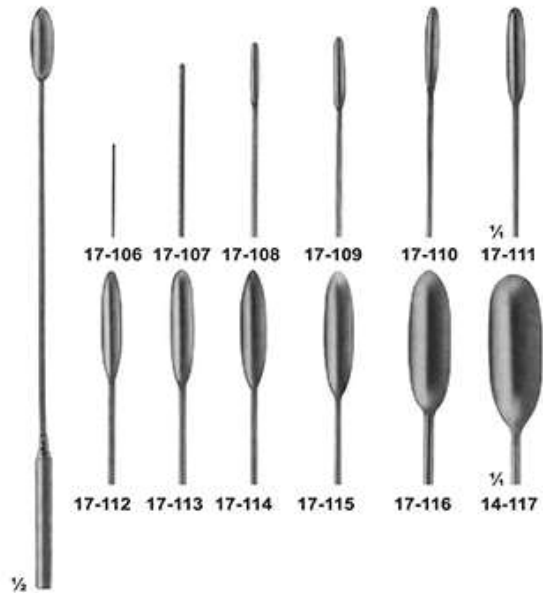

17-106 - 117
DE BAKEY
Vascular dilators,
malleable
190 mm

17-106	0,5 mm Ø	17-112	3,5 mm Ø
17-107	1,0 mm Ø	17-113	4,0 mm Ø
17-108	1,5 mm Ø	17-114	4,5 mm Ø
17-109	2,0 mm Ø	17-115	5,0 mm Ø
17-110	2,5 mm Ø	17-116	7,0 mm Ø
17-111	3,0 mm Ø	17-117	9,0 mm Ø

Tound-and Tracheal Hooks and Dilators



16-169
BOSE
165 mm



16-170
BOSE
165 mm

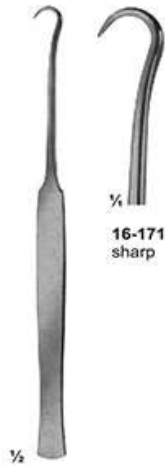

16-171 - 173
180 mm

16-171
sharp



16-172
blunt



16-173
stumpf/blunt



16-174
FINSEN
50 mm



16-175
FINSEN
70 mm



16-176
TROUSSEAU
120 mm



16-177
LABORDE
125 mm



16-178
LABORDE
strong pattern
135 mm



16-179
Cleaning Brush
for tracheal tubes
285 mm

Tound-and Tracheal Hooks and Dilators

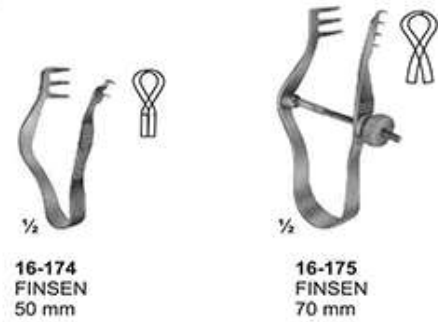
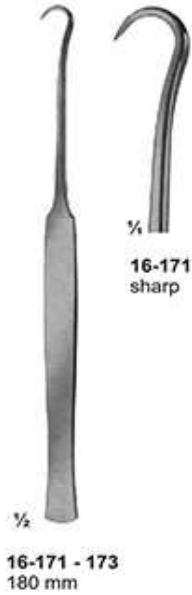

Tracheal Tubes with inner tubes



½

16-137
UECKERMANN-DENKER
Cryothyrotomy trocar
with silver cannula
130mm

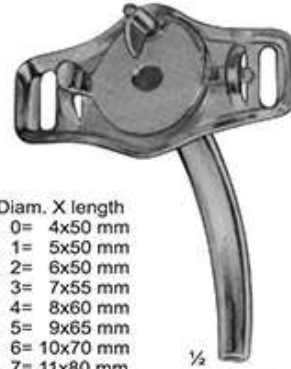

½

16-138 - 148
LUER
German silver

- Diam. X length
- 16-138** Fig. 0= 4x50 mm
 - 16-139** Fig. 1= 5x50 mm
 - 16-140** Fig. 2= 6x50 mm
 - 16-141** Fig. 3= 7x55 mm
 - 16-142** Fig. 4= 8x60 mm
 - 16-143** Fig. 5= 9x65 mm
 - 16-144** Fig. 6= 10x70 mm
 - 16-145** Fig. 7= 11x80 mm
 - 16-146** Fig. 8= 12x85 mm
 - 16-147** Fig. 9= 13x90 mm
 - 16-148** Fig. 10=14x90 mm



½

16-149 - 158
JACKSON
German Silver

- Diam. X length
- 16-149** Fig. 0= 4x50 mm
 - 16-150** Fig. 1= 5x58 mm
 - 16-151** Fig. 2= 6x58 mm
 - 16-152** Fig. 3= 7x70 mm
 - 16-153** Fig. 4= 8x78 mm
 - 16-154** Fig. 5= 9x84 mm
 - 16-155** Fig. 6= 10x84 mm
 - 16-156** Fig. 7= 11x86 mm
 - 16-157** Fig. 8= 12x88 mm
 - 16-158** Fig. 9= 13x90 mm



½

16-159 - 168
JACKSON
German Silver

- Diam. X length
- 16-159** Fig. 1= 5x48 mm
 - 16-160** Fig. 2= 6x58 mm
 - 16-161** Fig. 3= 7x70 mm
 - 16-162** Fig. 4= 8x78 mm
 - 16-163** Fig. 5= 9x84 mm
 - 16-164** Fig. 6= 10x84 mm
 - 16-165** Fig. 7= 11x86 mm
 - 16-166** Fig. 8= 12x88 mm
 - 16-167** Fig. 9= 13x90 mm
 - 16-168** Fig.10= 14x90 mm

Obstetrics-Placenta and Ovum Forceps

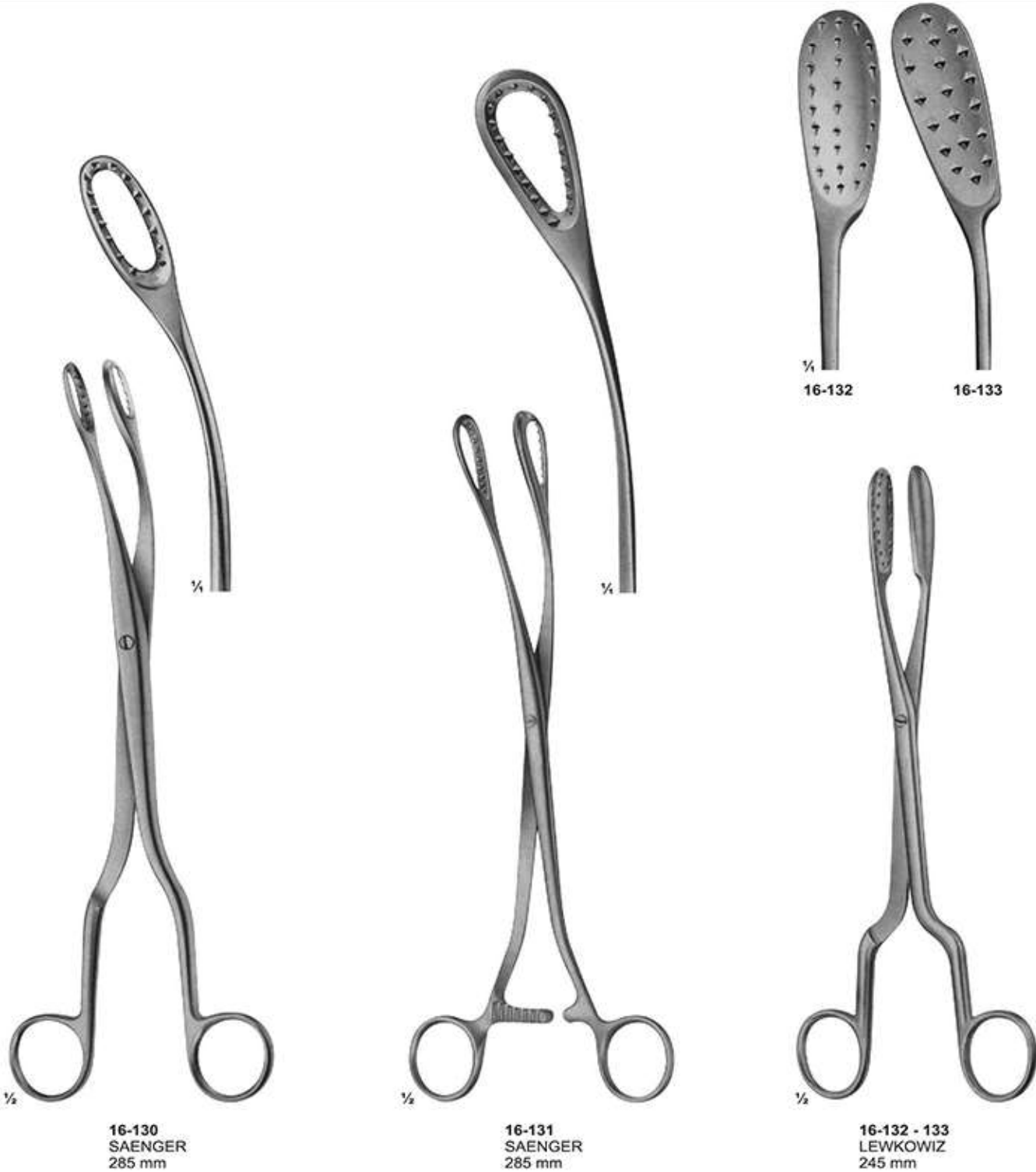

Obstetrics-Placenta and Ovum Forceps

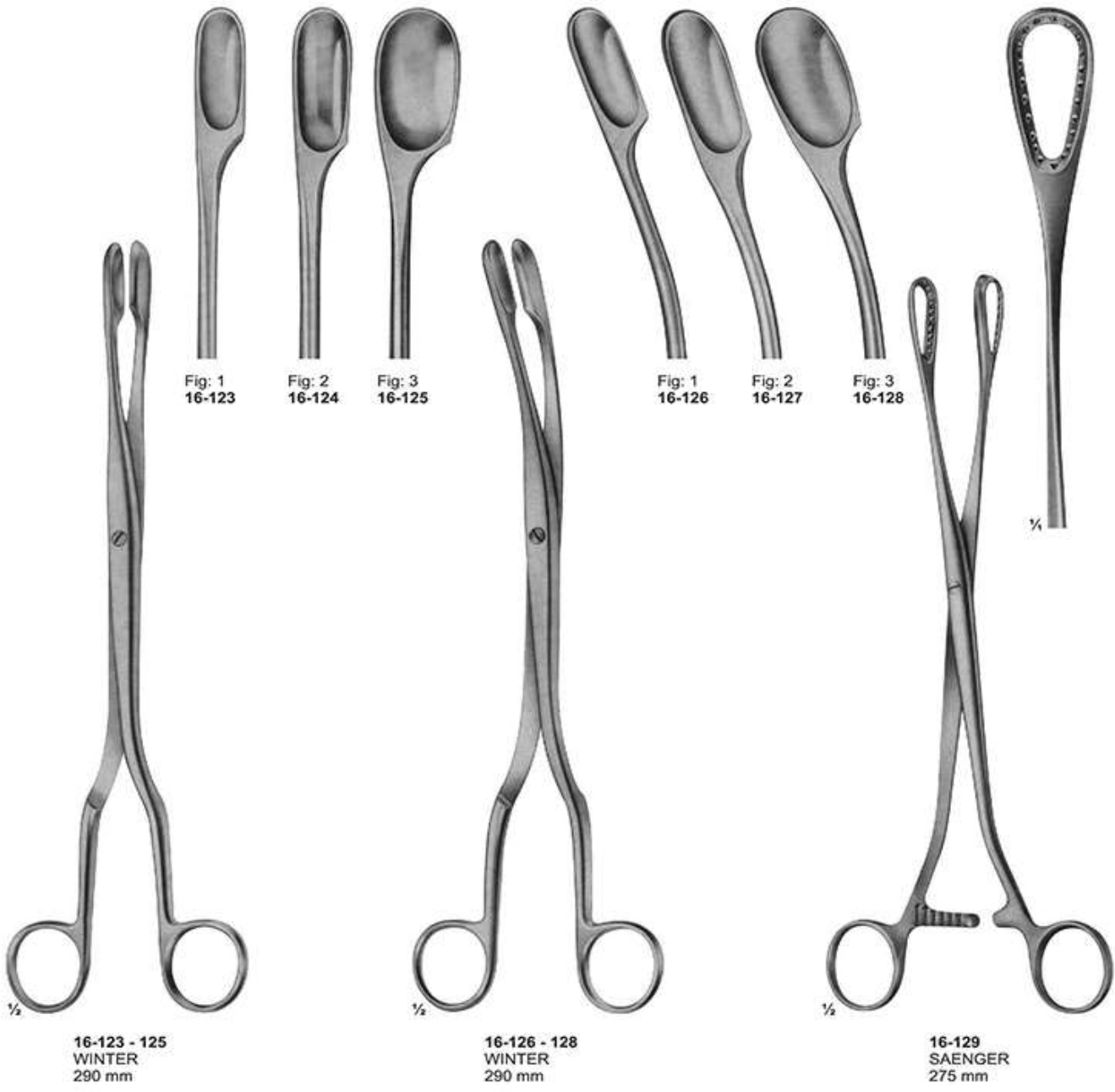

Obstetrics Forceps

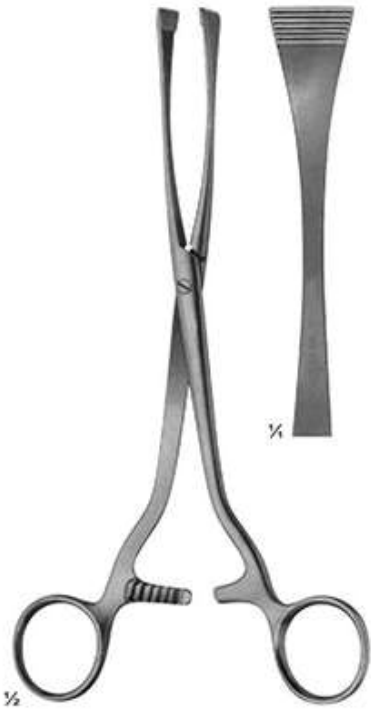

16-120
GREEN-ARMYTAGE
Caesarean section haemostatic
forceps, for edges of the transverse
incision in the lower segment
220 mm



16-121
WILLETT
Scalpel Flap forceps
185 mm



16-122
GAUSS
Scalpel Flap forceps
260 mm

Obstetrics Forceps



1/4
16-117
SIMPSON-BRAUN
305mm



1/4
16-118
SIMPSON
235mm



1/4
16-119
WRIGLEY
250 mm

Obstetrics Forceps



1/3
16-114
355 mm



1/3
16-115
400 mm



1/3
16-116
SIMPSON-BRAUN
305mm

Scissors of Obstetrics, Umbilical cord clamp



1/2
16-109
SCHUMACHER
Umbilical cord
scissors
155 mm



1/2
16-110
Umbilical cord
scissors
105 mm

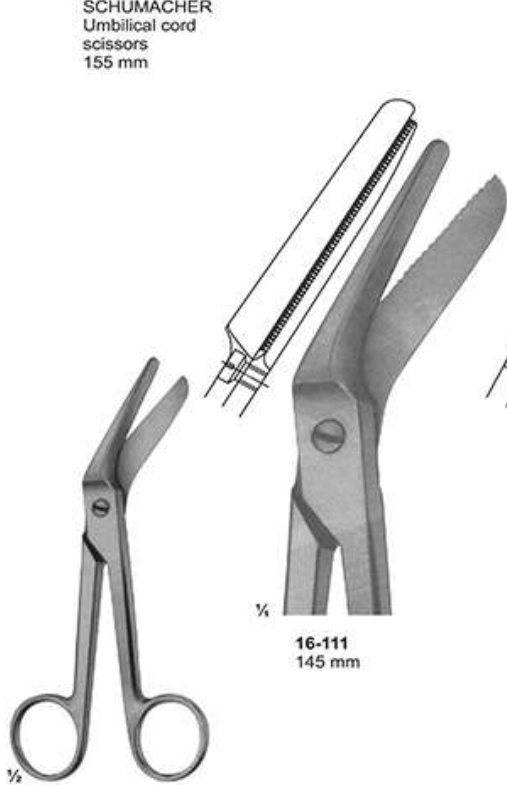

1/2
16-111 - 112
BRAUN-STADLER
Episiotomy Scissors

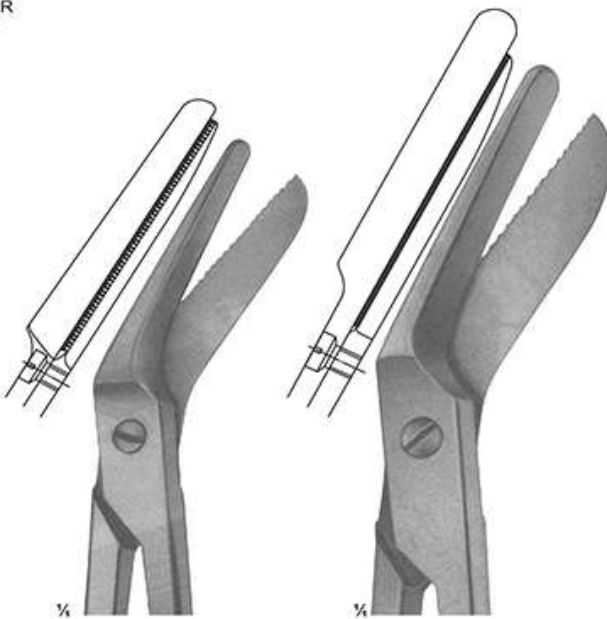

1/4
16-111
145 mm

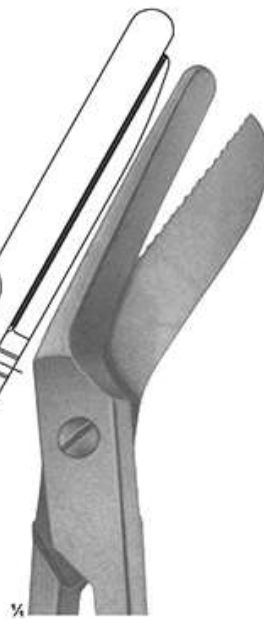

1/4
16-112
200 mm

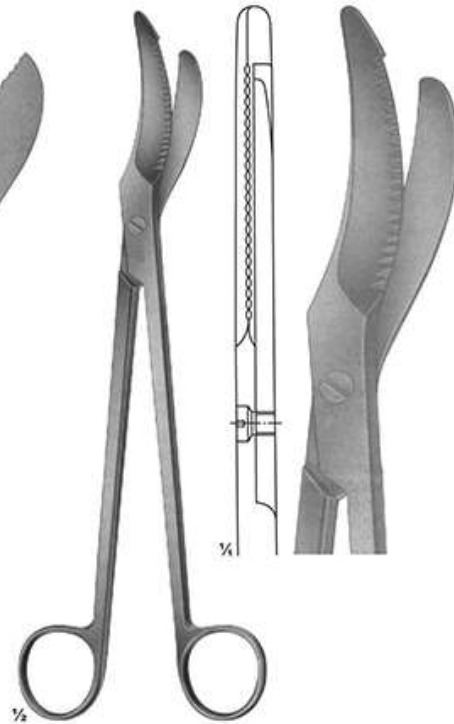

1/2
16-113
Episiotomy Scissors
240 mm

Obstetrics-Pelvimeters

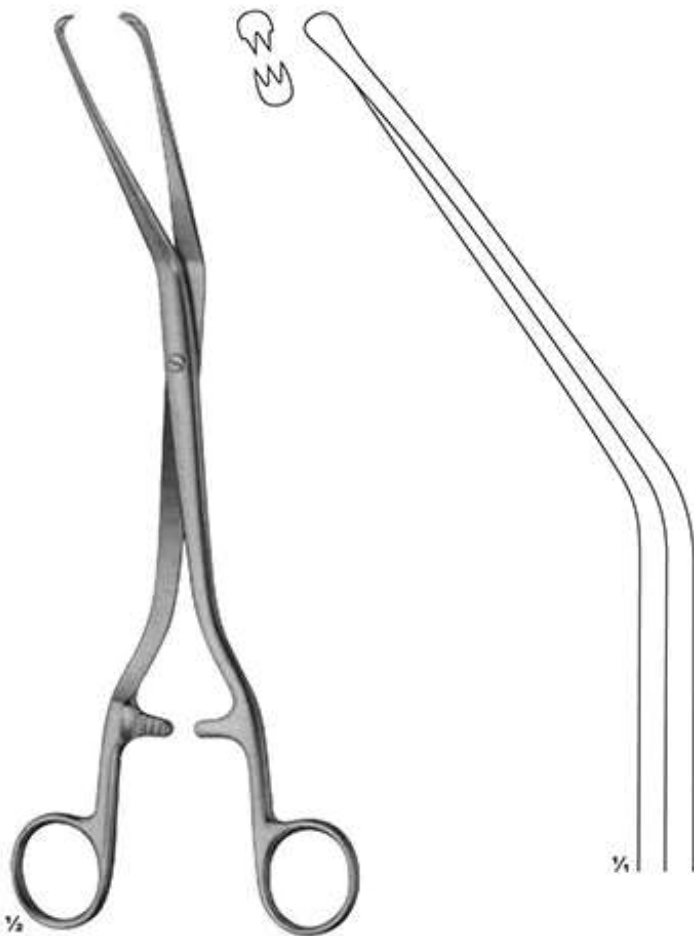

16-107
HERFF
puncturing forceps
225 mm



16-108
IOWA
puncturing forceps
260 mm

Obstetrics-Pelvimeters

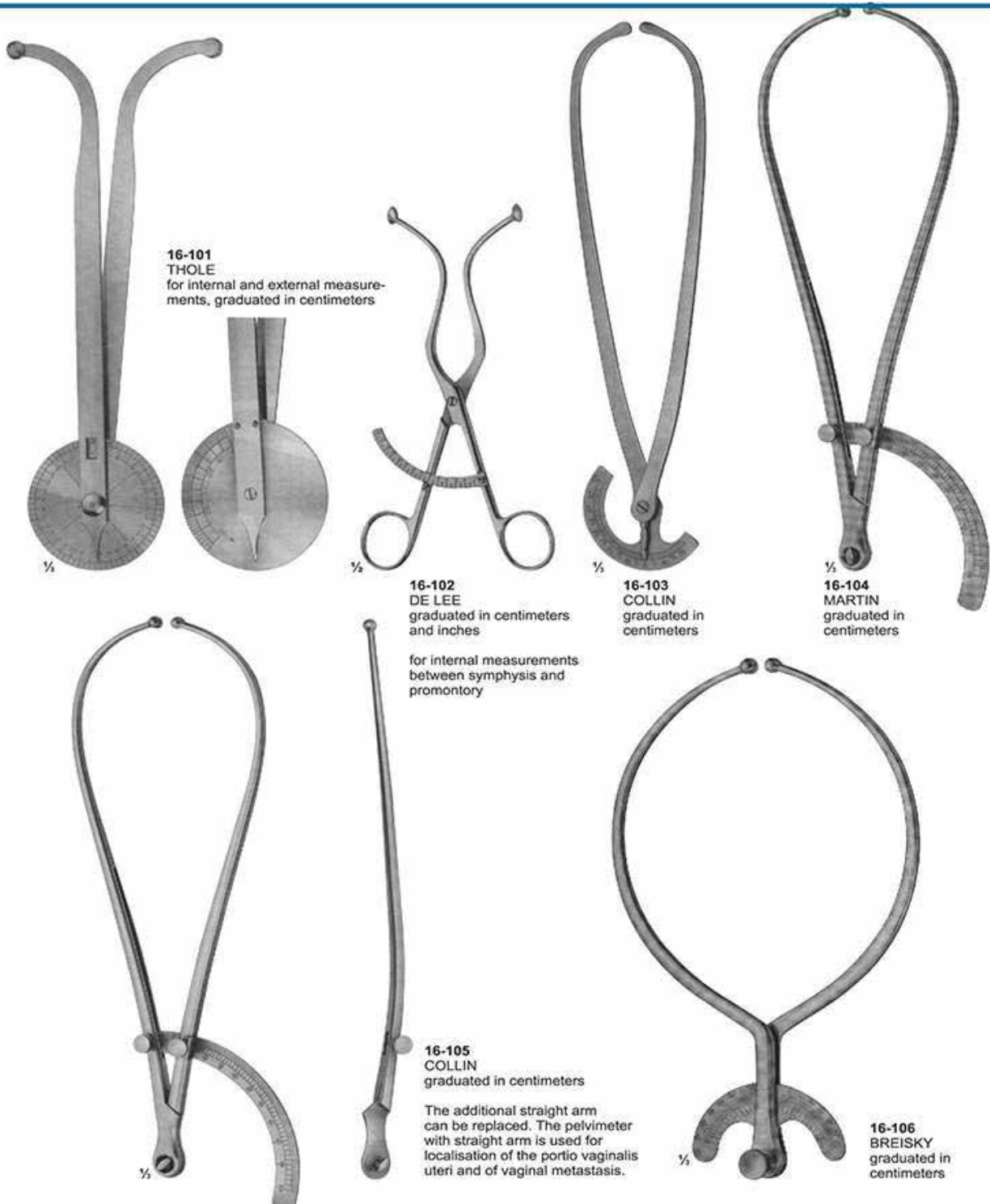

Gynaecological Instruments



15-143 diam 8 mm
15-144 diam 10 mm
BOZEMANN-FRITSCH
Uterine Flushing Tube
350 mm



15-145
SCHULZE
Salpingograph, for utero-salpingography
in wooden case, consisting of:
Manometer, Connection, Uterine canulla
with tap, Cone S.M.L.,
Record Syringe 10 cc, Luer lock mount.

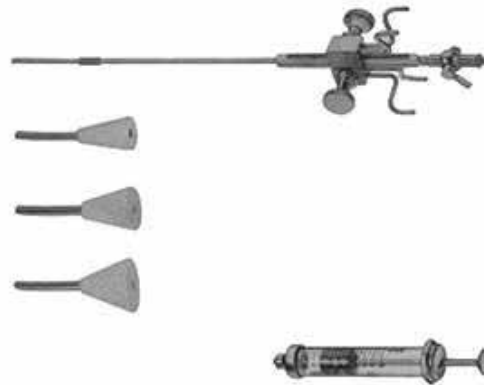

15-146
SCHULZE
Salpingograph, equipment
without manometer.



Placenta-and Ovum Curettes



1/4



1/2
15-130
COLLIN
300 mm



1/2
15-131
RECAMIER
blunt-rigid
360 mm

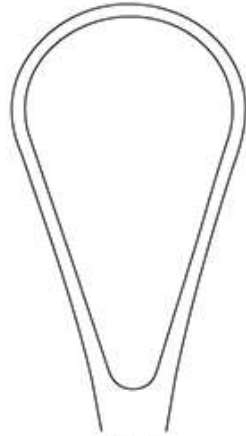
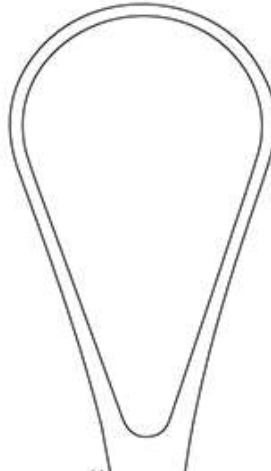

Fig:1



1/4
Fig:2



1/2
15-132
BUMM
310 mm

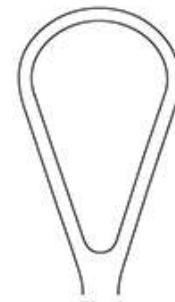

Fig:1

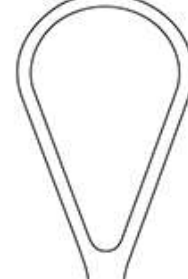
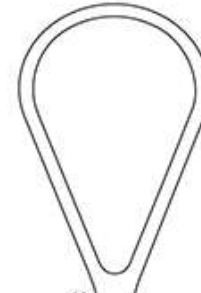
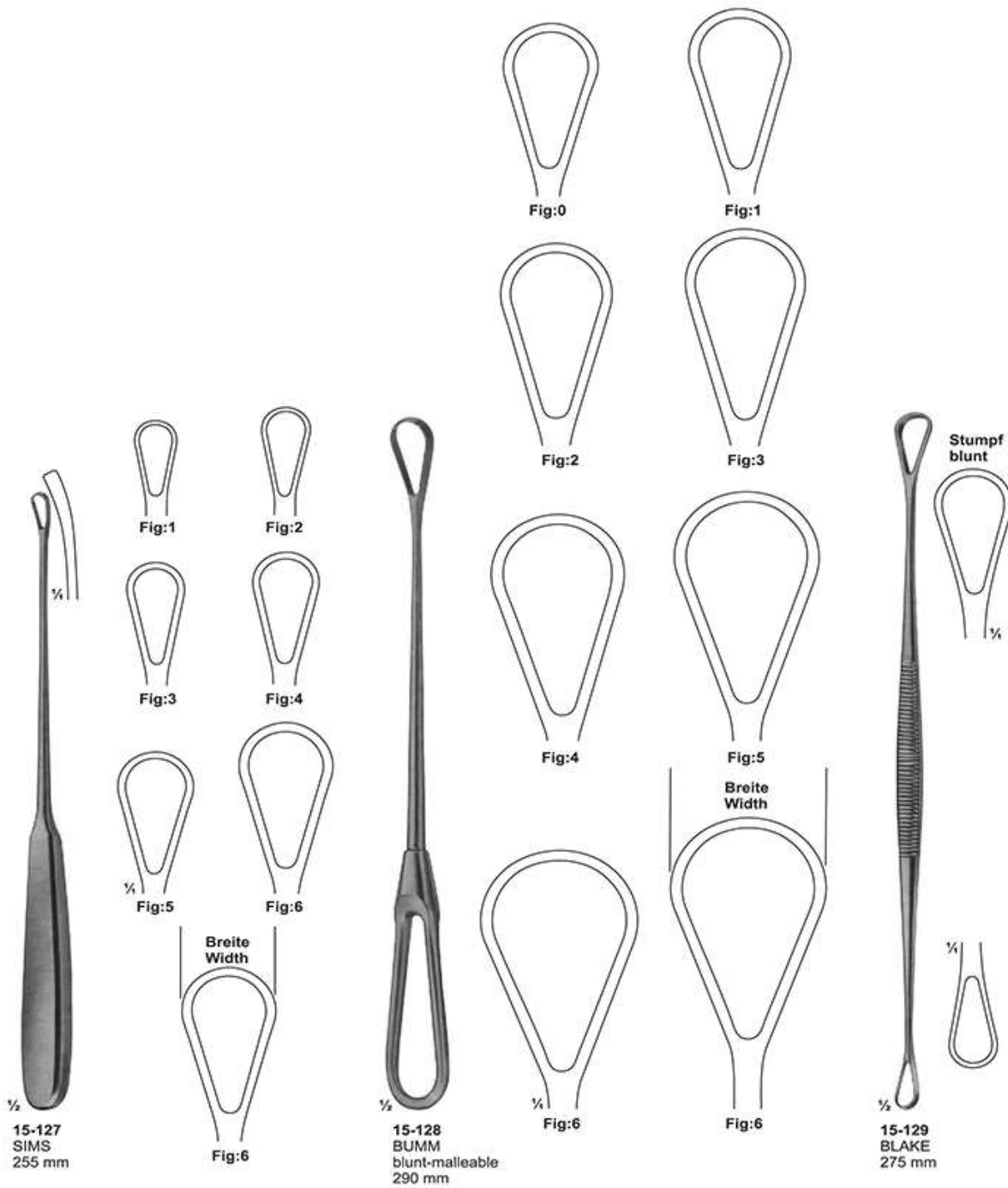

Fig:2



1/4
Fig:3

Uterine Curettes



Uterine Scoops

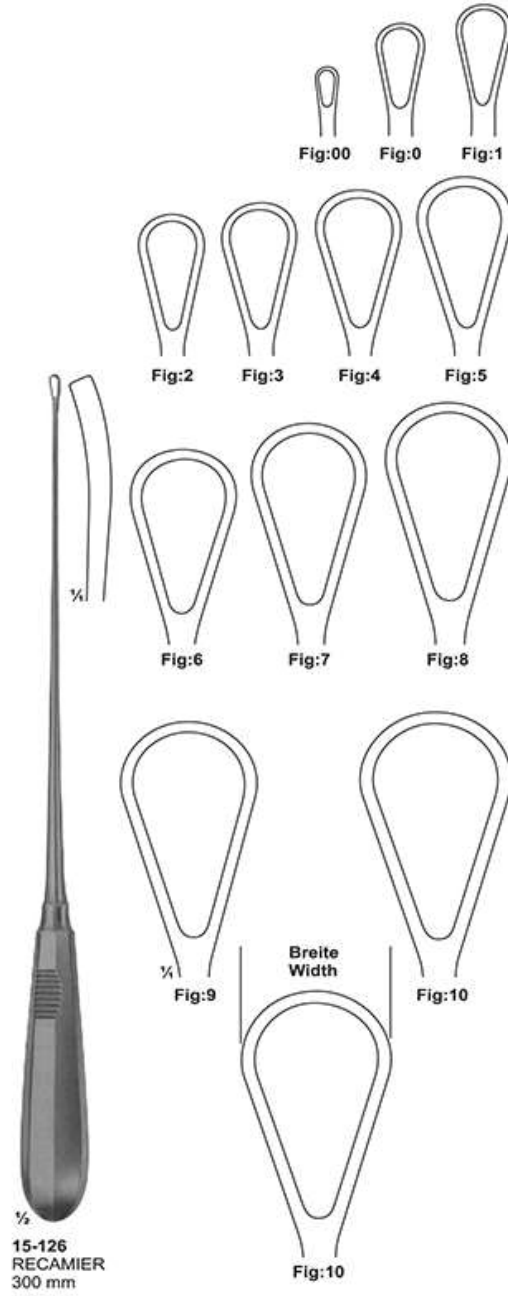
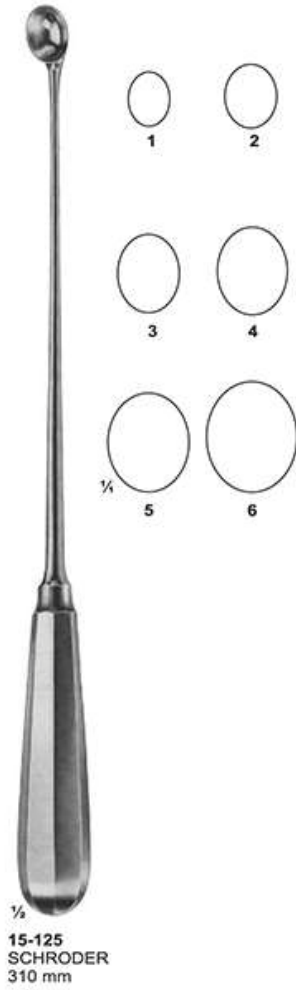
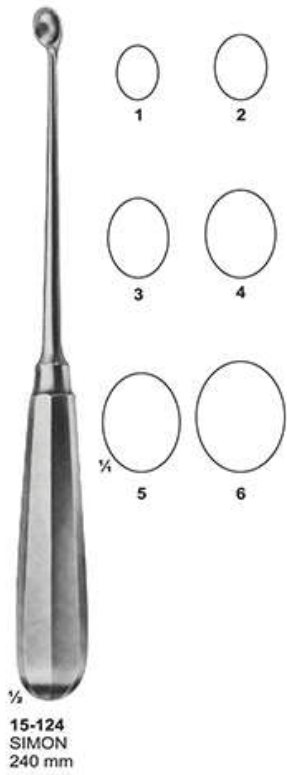

Biopsy Forceps

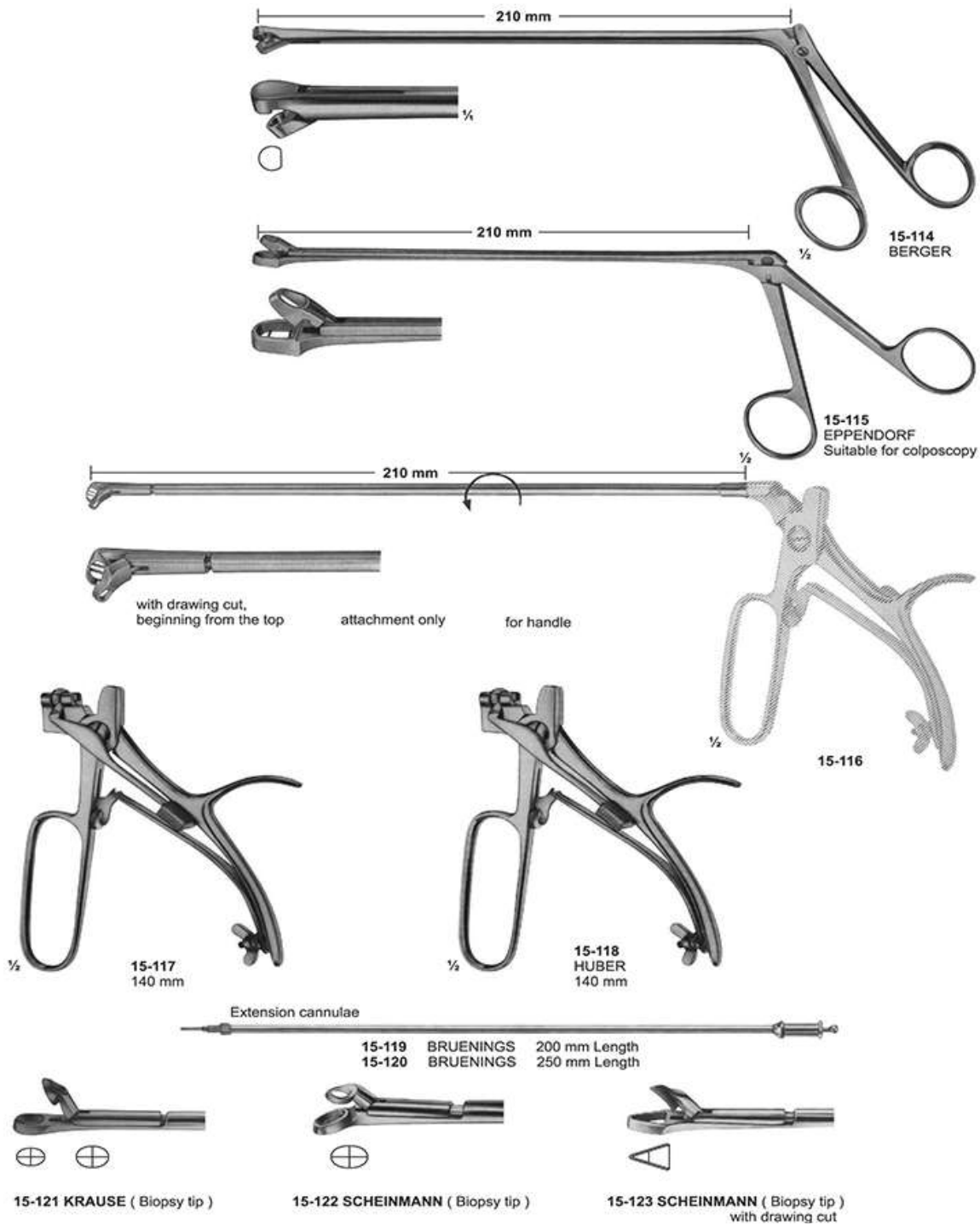

Biopsy Forceps

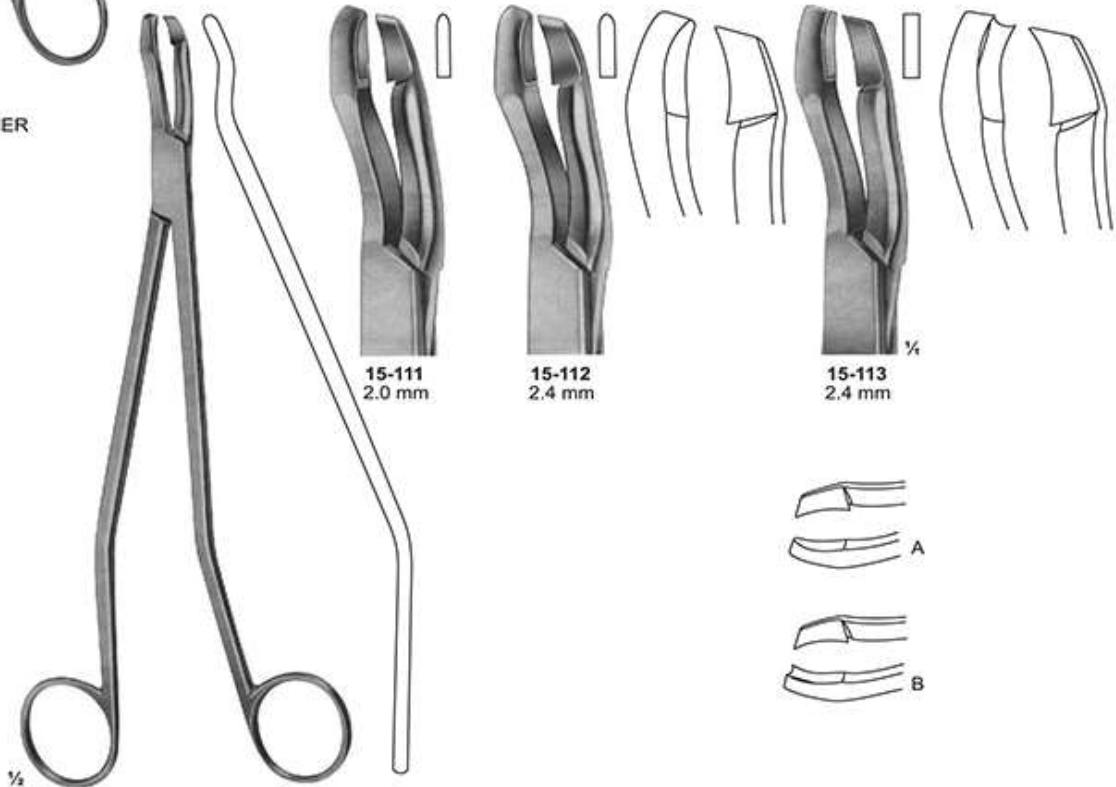
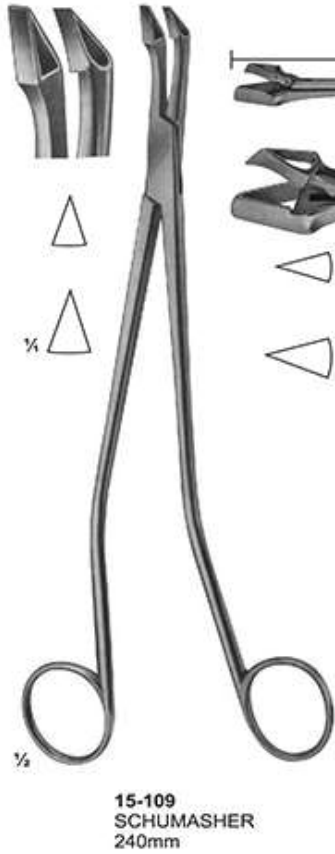
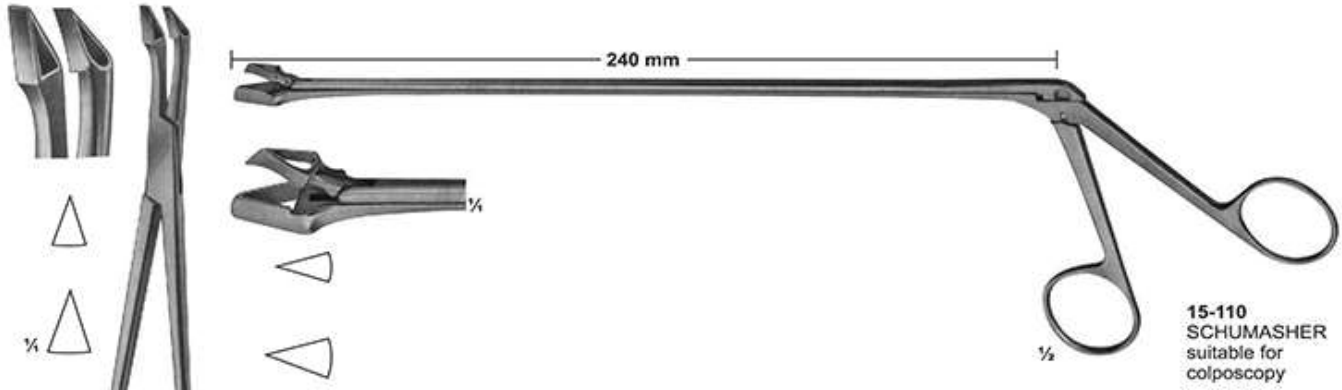

15-111 - 113
SEIDL DBP
Biopsy forceps, bayonet shaped
for portio, vagina and vulva
240mm

Biopsy Forceps



15-105
THOMS-GAYLOR
240 mm



15-106
SCHUBERT
260 mm

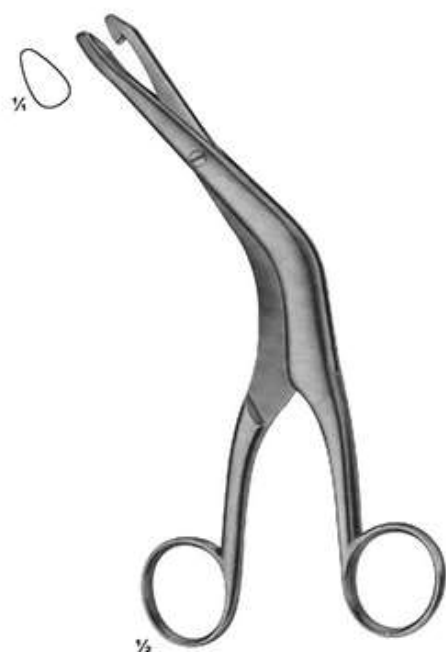

15-107
FAURE
210 mm

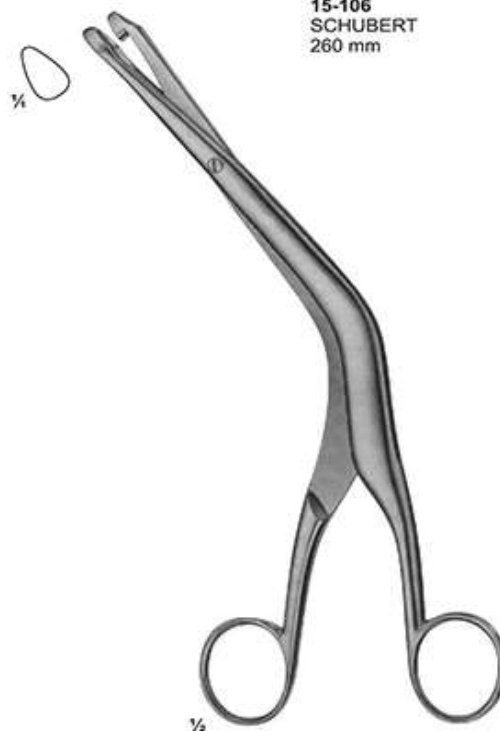

15-108
FAURE
240 mm

Biopsy Curettes

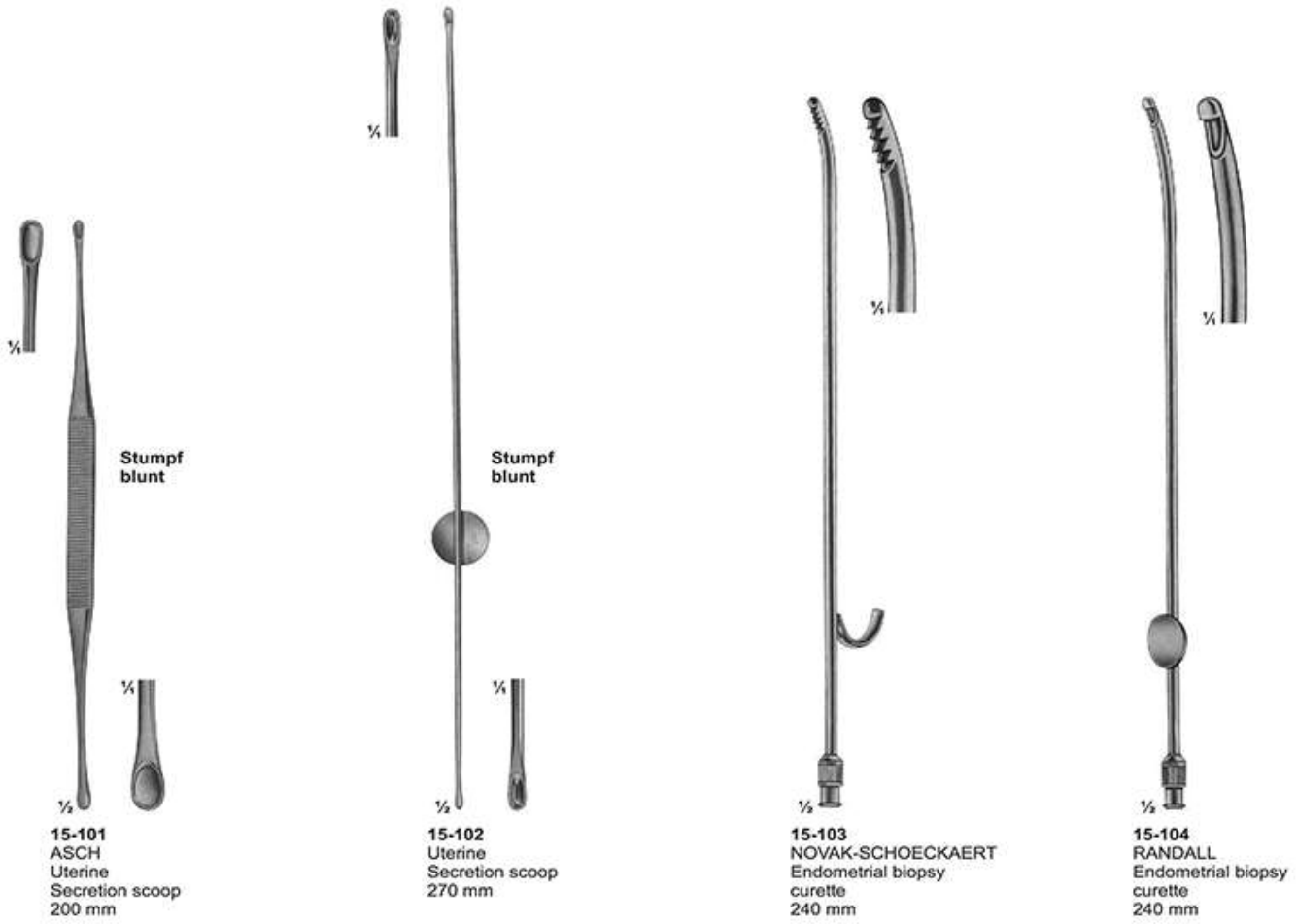

Myoma Instruments

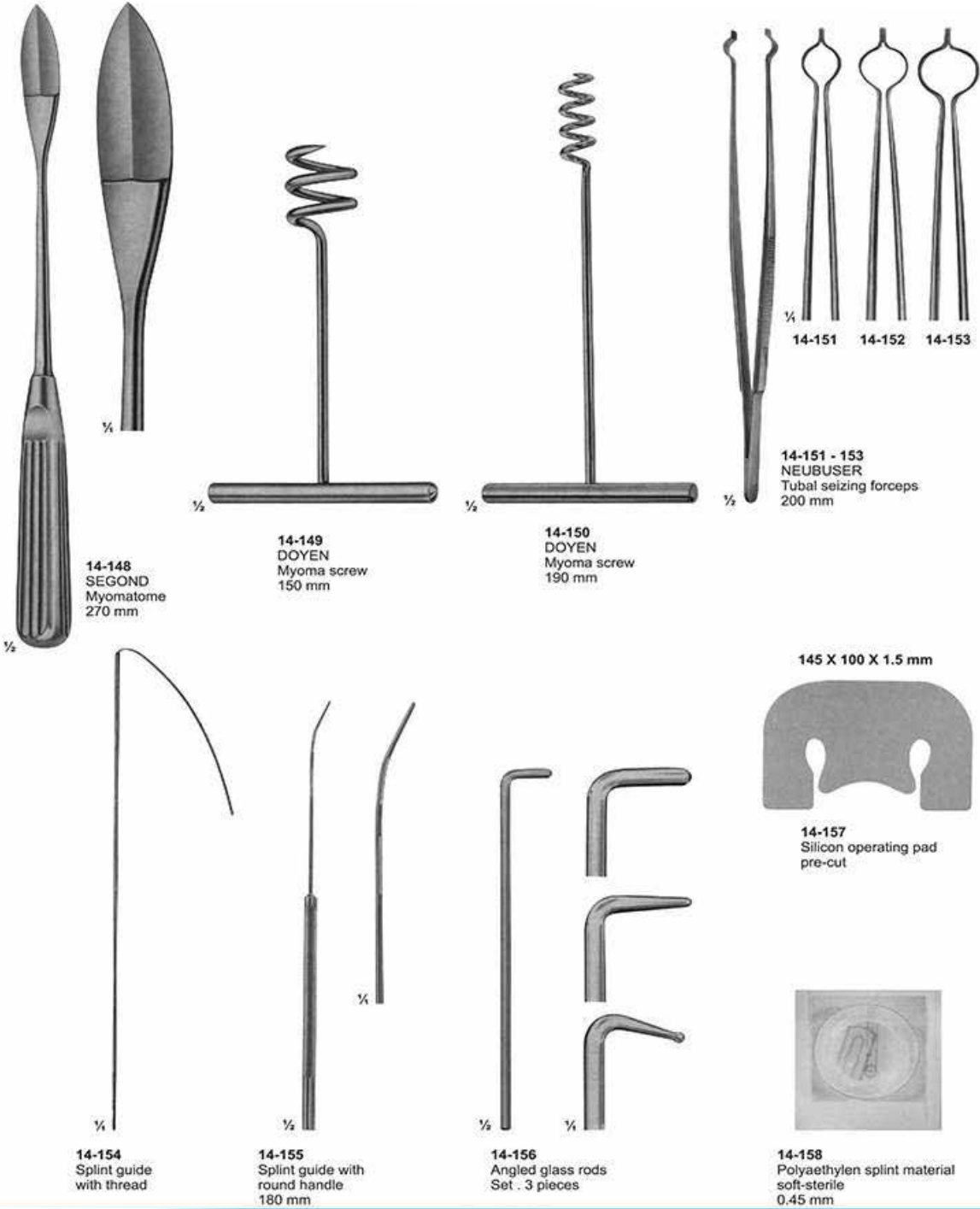

Uterine Elevating Forceps



14-146
COLLIN
265 mm



14-147
260 mm

Uterine Elevating Forceps



14-144
SOMER
235 mm



14-145
STRASSMANN
260 mm

Uterine Elevating Forceps

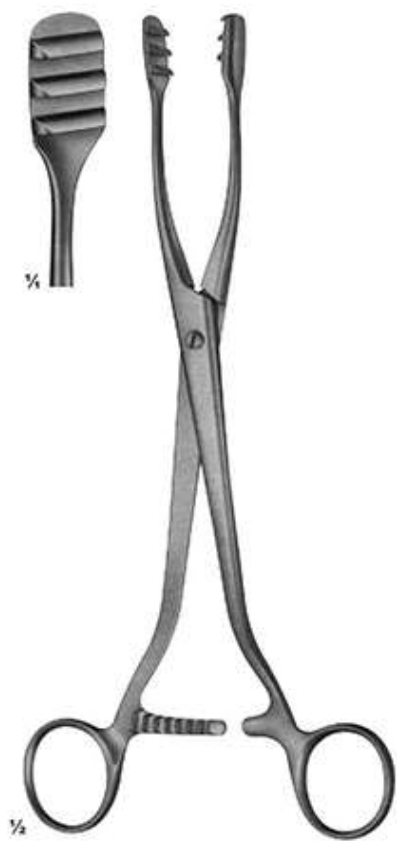

14-141
COLLIN
250 mm



14-142
COLLIN
285 mm



14-143
DARTIGUES
255 mm

Polypus and Ovum Forceps



¼



¼

14-138



¼

14-139



¼



¼

14-137
DOYEN
185 mm



¼

14-138 - 139
250 mm 270 mm

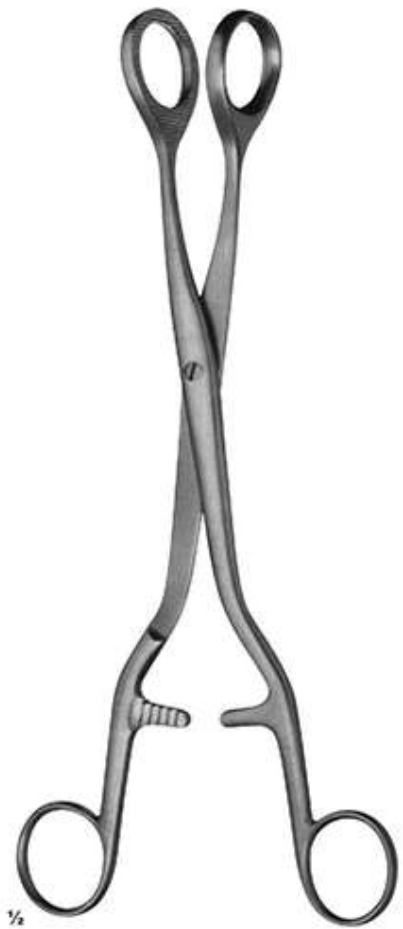

¼

14-140
BUMM
280 mm

Uterine Elevating Forceps

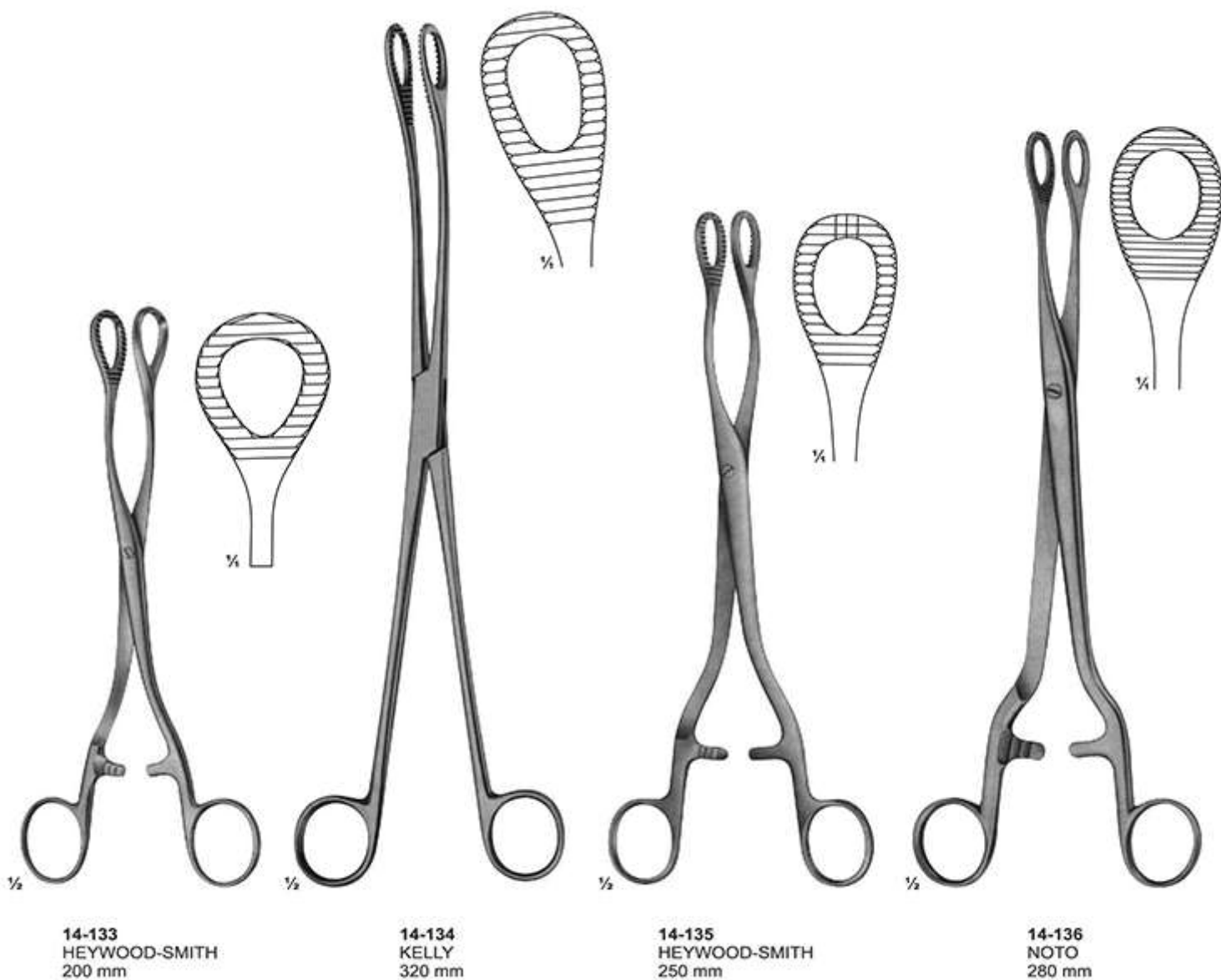

Uterine Tenaculum Forceps



14-127
JACOBS
215 mm



14-128
LITTLEWOOD
185 mm



14-129
MUSEUX
200 mm

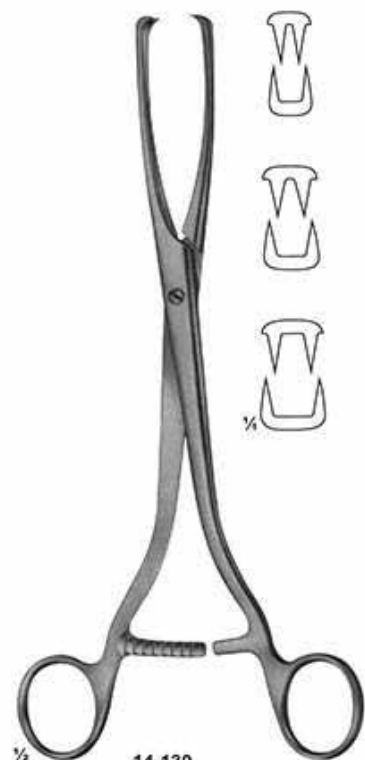

14-130
MUSEUX
240 mm

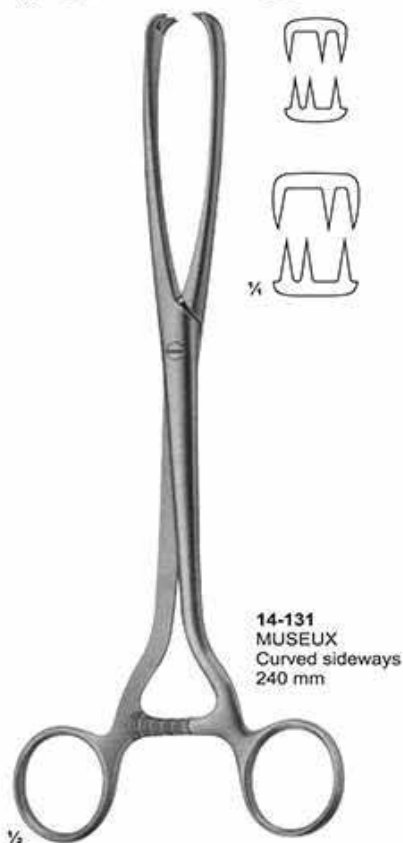

14-131
MUSEUX
Curved sideways
240 mm

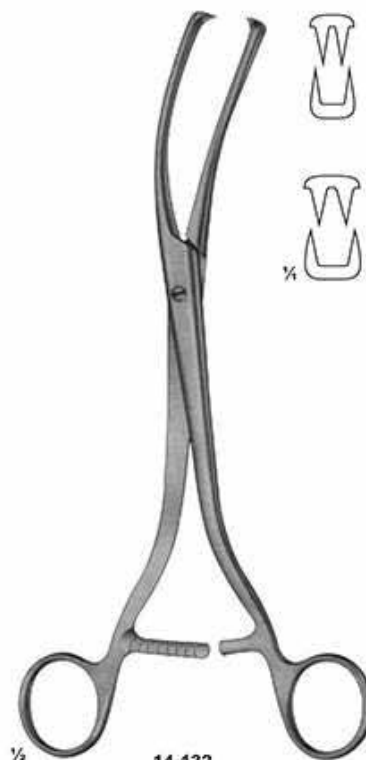

14-132
MUSEUX
240 mm

Uterine Tenaculum Forceps

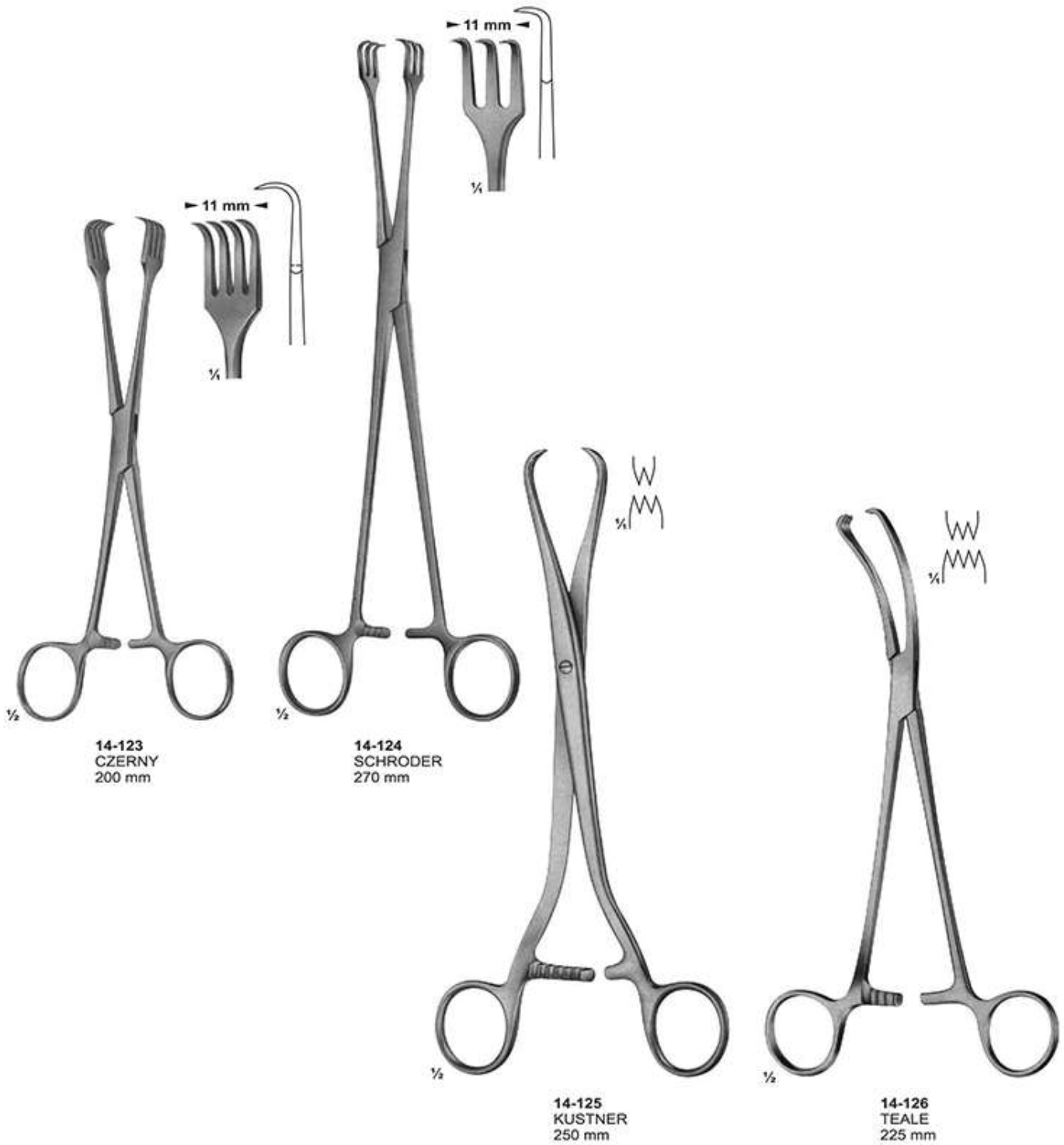

Uterine Tenaculum Forceps



14-117
265 mm

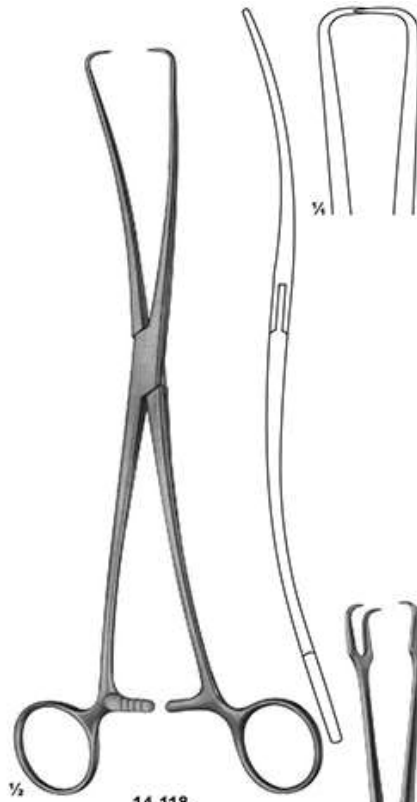

14-118
DUPLAY
250 mm

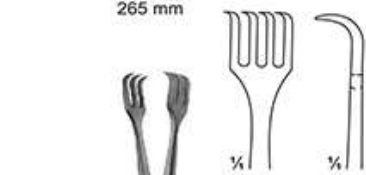

14-119
LAHEY
155 mm



14-120 - 122
SCHRODER
250 mm



14-120
straight



14-121
curved
on flat



14-122
curved
sideways

Uterine Tenaculum Forceps



14-114
BRAUN
slender type
250 mm



14-115
SCHRODER
250 mm

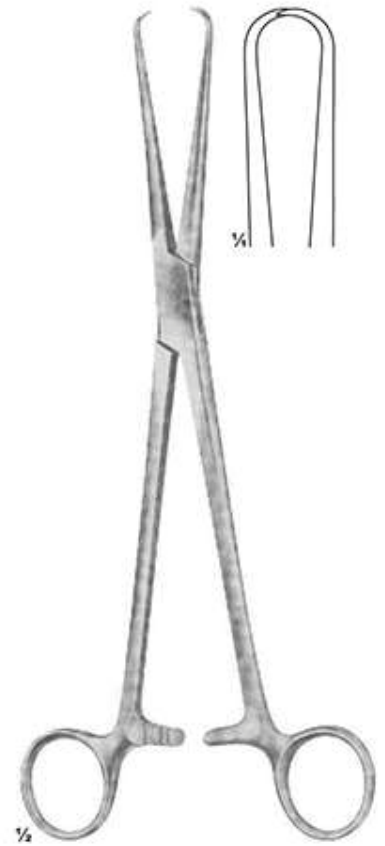

14-116
POZZI
heavy type
255 mm

Uterine Dressing Forceps

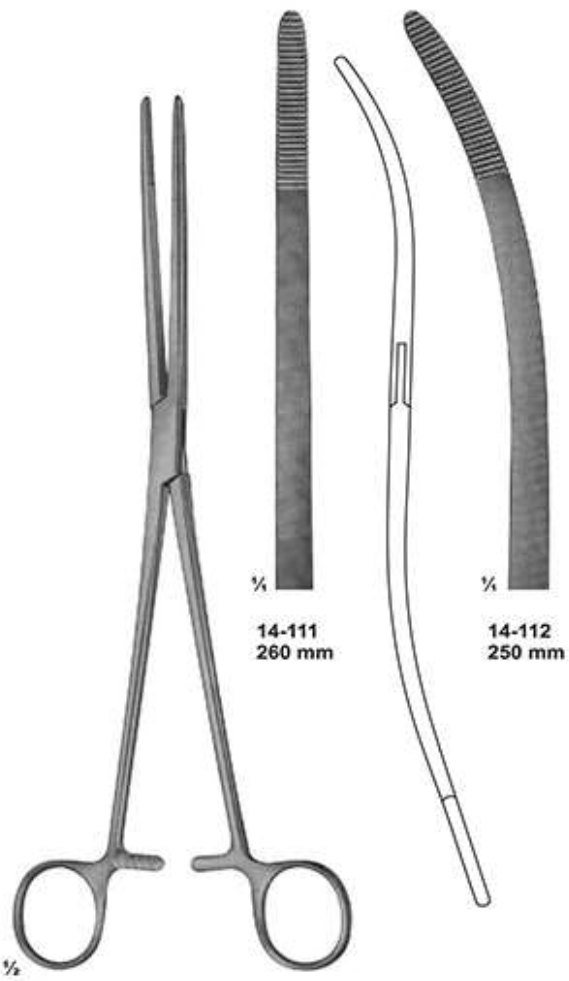

14-111 - 112
BOZEMANN

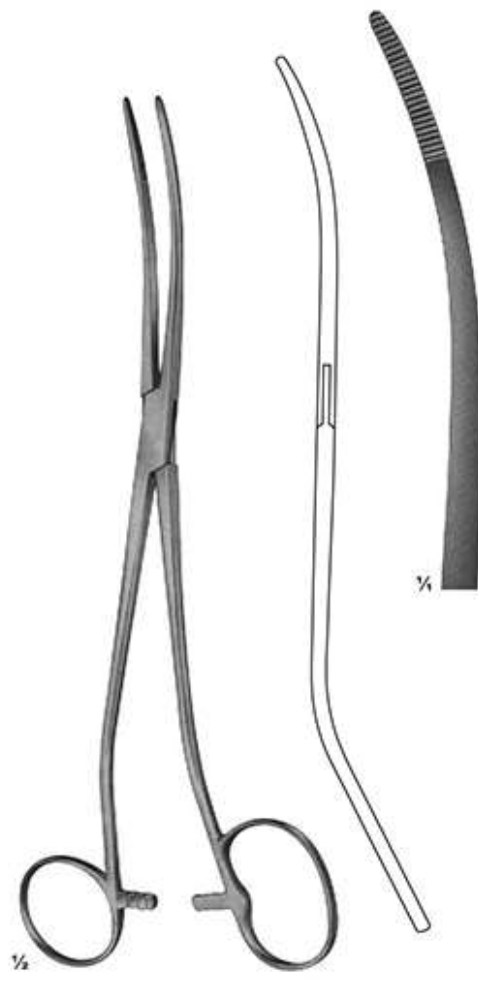

14-113
BOZEMANN-DOUGLAS
260 mm

Uterine Dressing Forceps



14-107
PELKMANN
260 mm



14-108
PELKMANN
260 mm



14-109
BOZEMANN
250 mm



14-110
BOZEMANN
255 mm

Jaws with longitudinal groove

Uterine Probes

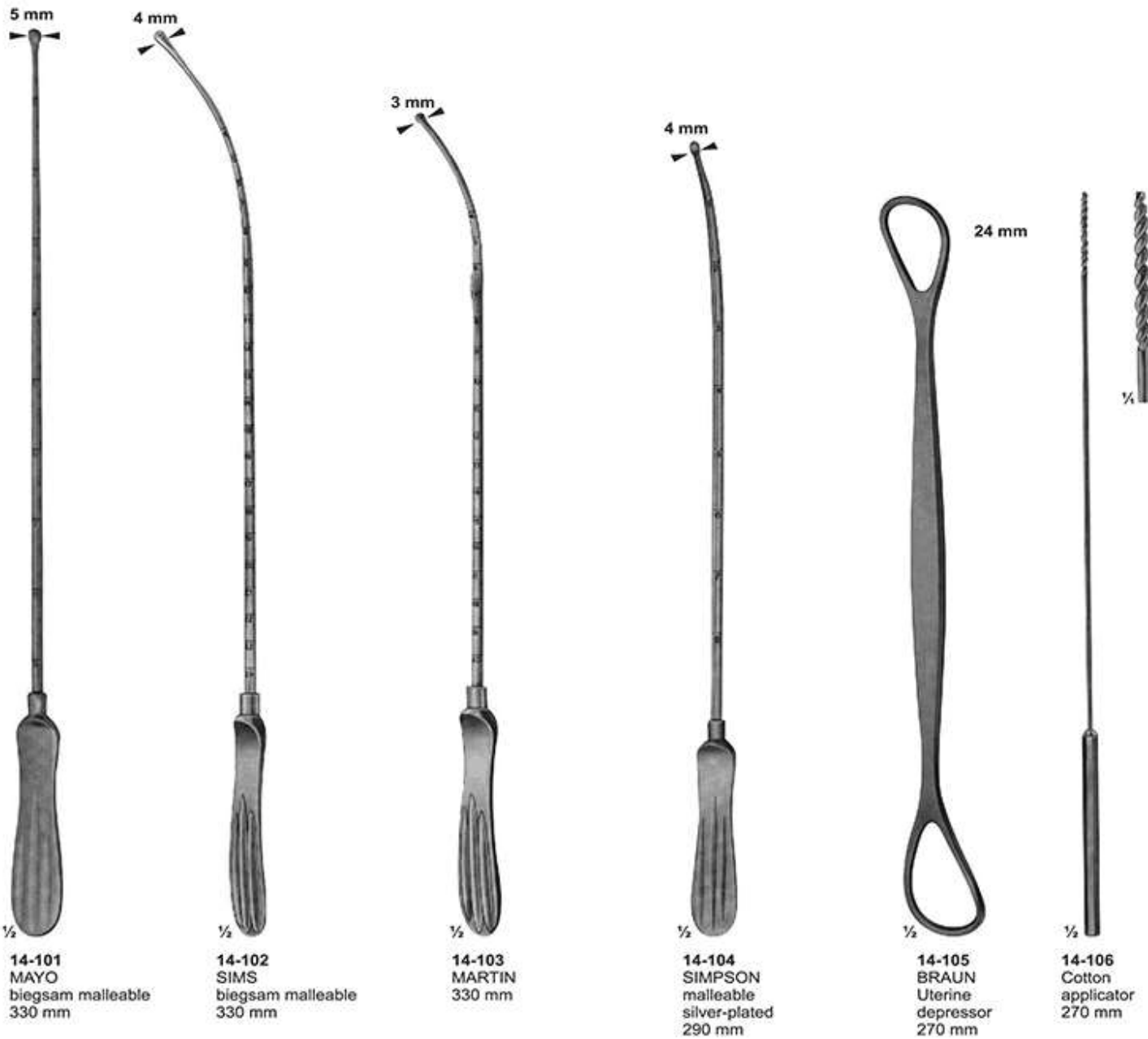

Endospecula For Cervix

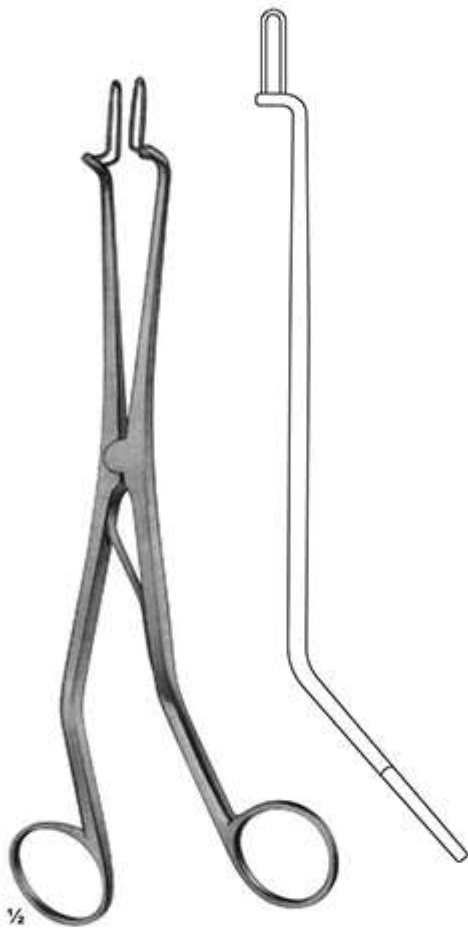

13-156
KOGAN
Endospecula for cervix
and urethra, without ratchet
240 mm



13-157
KOGAN
Endospecula for cervix
and urethra, with
scale-ratchet and fixing screws
240 mm

Uterine Dilators - Complete Sets



13-154
HEGAR
Dilator set consisting of:
14 Dilators,
1 Rack for dilators (4 - 12 mm)
1 Rack for Dilators (13 - 17 mm)
1 Metal case only,
with hinged lid, stainless 200 X 100 X 35 mm

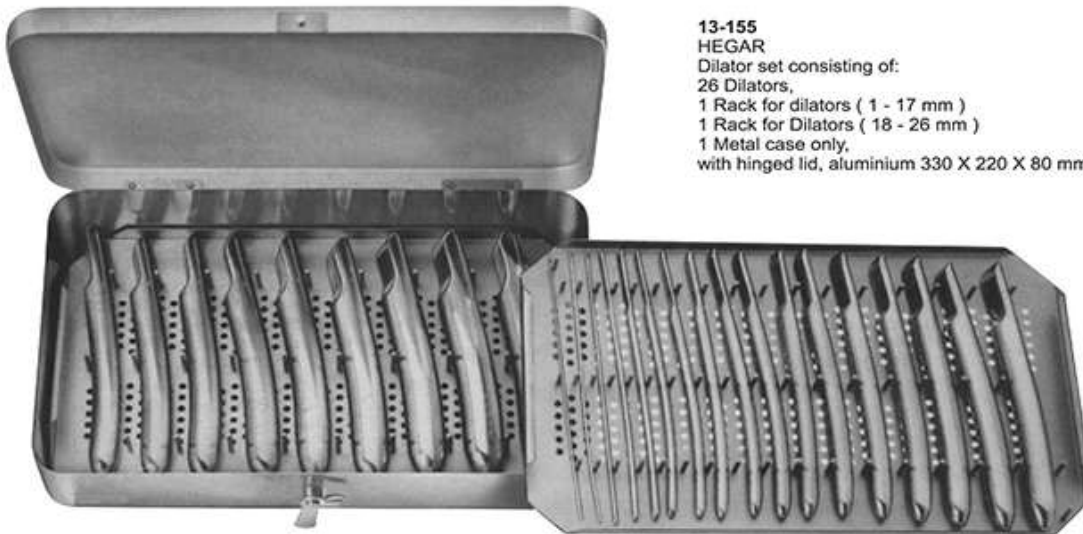

13-155
HEGAR
Dilator set consisting of:
26 Dilators,
1 Rack for dilators (1 - 17 mm)
1 Rack for Dilators (18 - 26 mm)
1 Metal case only,
with hinged lid, aluminium 330 X 220 X 80 mm

Uterine Dilators



13-101	1	mm	13-123	23	mm
13-102	2	mm	13-124	24	mm
13-103	3	mm	13-125	25	mm
13-104	4	mm	13-126	26	mm
13-105	5	mm	13-127	1	½mm
13-106	6	mm	13-128	2	½mm
13-107	7	mm	13-129	3	½mm
13-108	8	mm	13-130	4	½mm
13-109	9	mm	13-131	5	½mm
13-110	10	mm	13-132	6	½mm
13-111	11	mm	13-133	7	½mm
13-112	12	mm	13-134	8	½mm
13-113	13	mm	13-135	9	½mm
13-114	14	mm	13-136	10	½mm
13-115	15	mm	13-137	11	½mm
13-116	16	mm	13-138	12	½mm
13-117	17	mm	13-139	13	½mm
13-118	18	mm	13-140	14	½mm
13-119	19	mm	13-141	15	½mm
13-120	20	mm	13-142	16	½mm
13-121	21	mm	13-143	17	½mm
13-122	22	mm			

13-101 - 143
HEGAR
with very conical point
185 mm



13-144	1+2	mm
13-145	3+4	mm
13-146	5+6	mm
13-147	7+8	mm
13-148	9+10	mm
13-149	11+12	mm
13-150	13+14	mm
13-151	15+16	mm
13-152	17+18	mm

13-144 - 152
HEGAR
205 mm

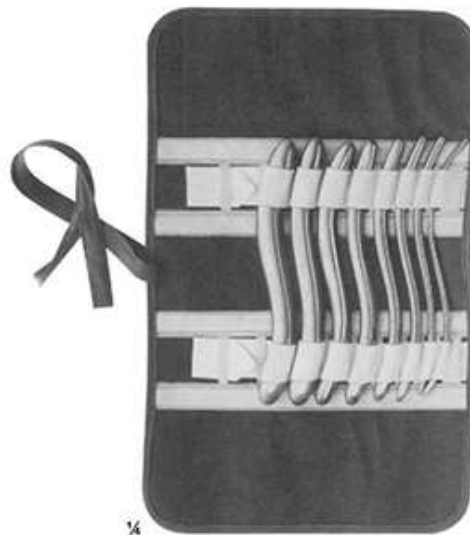

13-153
HEGAR
Uterine dilator set, in canvas
roll with 8 dilators.

Vaginal Retractors



12-221
JOLL (FRIEDMAN)
155 mm



12-222
RICHTER
170 mm



12-223
GELPI
135 mm



12-224
GELPI
175 mm

Vaginal Speculas

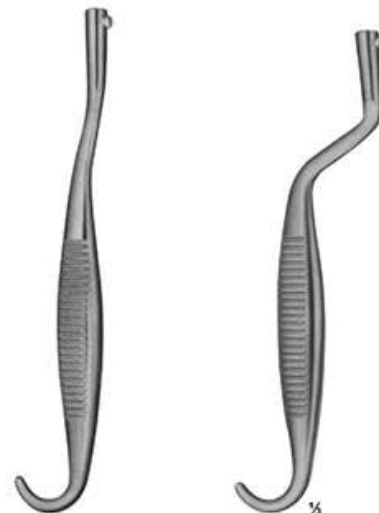
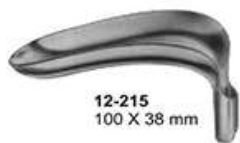
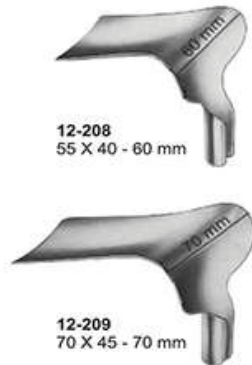

Vaginal & Wound Retractor / Vaginal Specula



**12-203
SIMON**
115 X 22 mm
275 mm



**12-204
AUVARD**
65 X 38 mm - 28 mm
1,530 kg
with fixed weight
230 mm



**12-205 - 206
AUVARD**
12-205 75 X 42 mm
(40 mm)
12-206 105 X 43 mm
(40 mm)
with detachable wight
230 mm



**12-207
MARTIN**
with hook shaped
handle for hanging
in weights
270 mm

Vaginal Specula / Retractors



12-190 - 194
 BREISKY
 WIENER MODELL/
 VIENNA PATTERN
 12-190 100 X 20 mm
 12-191 100 X 25 mm
 12-192 100 X 30 mm
 12-193 100 X 35 mm
 12-194 100 X 40 mm
 300 mm



12-195 - 199
 BREISKY
 WIENER MODELL/
 VIENNA PATTERN
 12-195 130 X 20 mm
 12-196 130 X 25 mm
 12-197 130 X 30 mm
 12-198 130 X 35 mm
 12-199 130 X 40 mm
 320 mm



12-200 - 201
 WEISSBARTH
 12-200 80 X 28 mm
 12-201 85 X 42 mm
 210 mm



12-202
 DOYEN
 lateral speculum
 80 x 30 mm
 250 mm

Vaginal Specula-for children and virgins

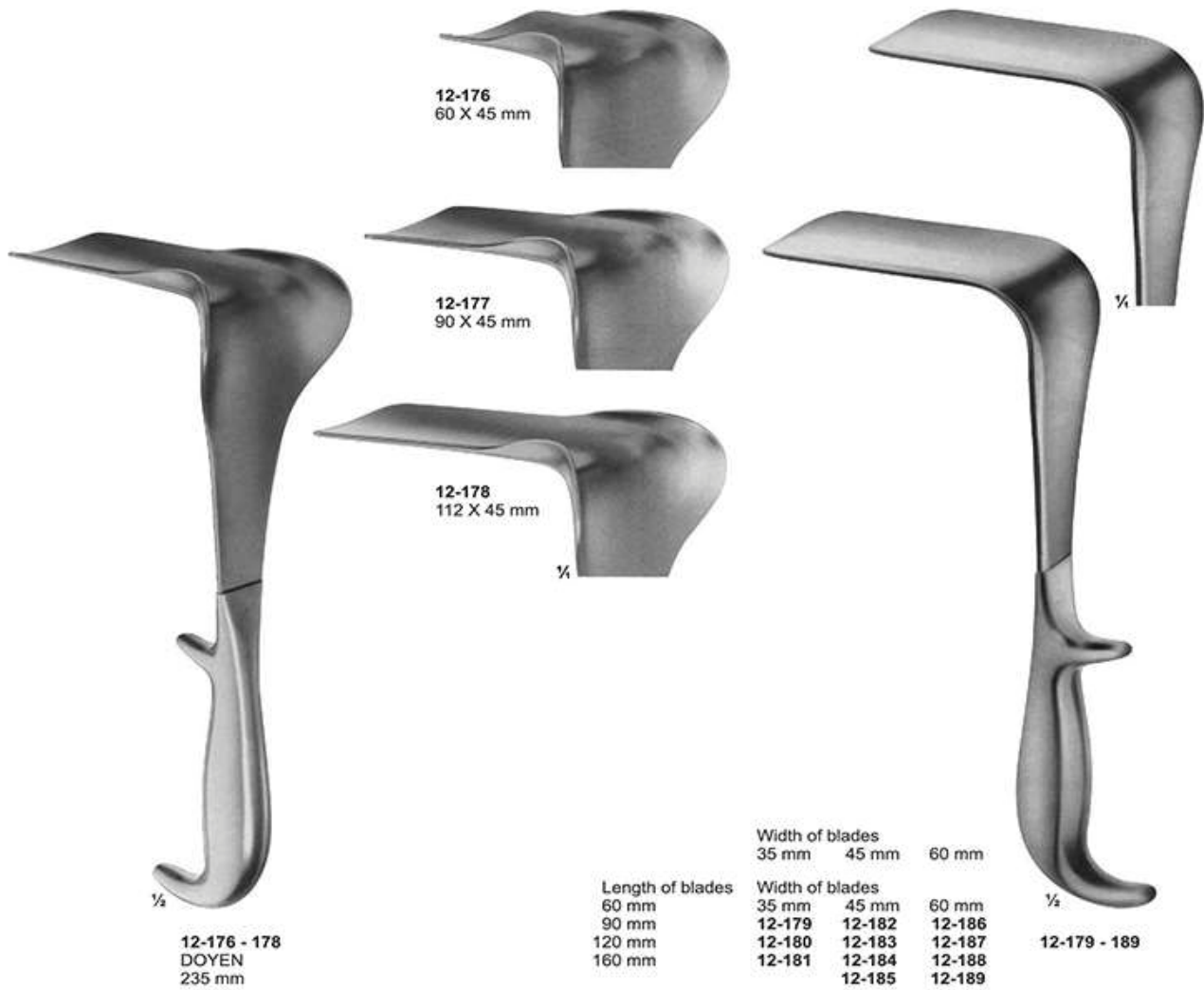

Vaginal Specula-for children &virgins / Vario Retractor



Vaginal Specula

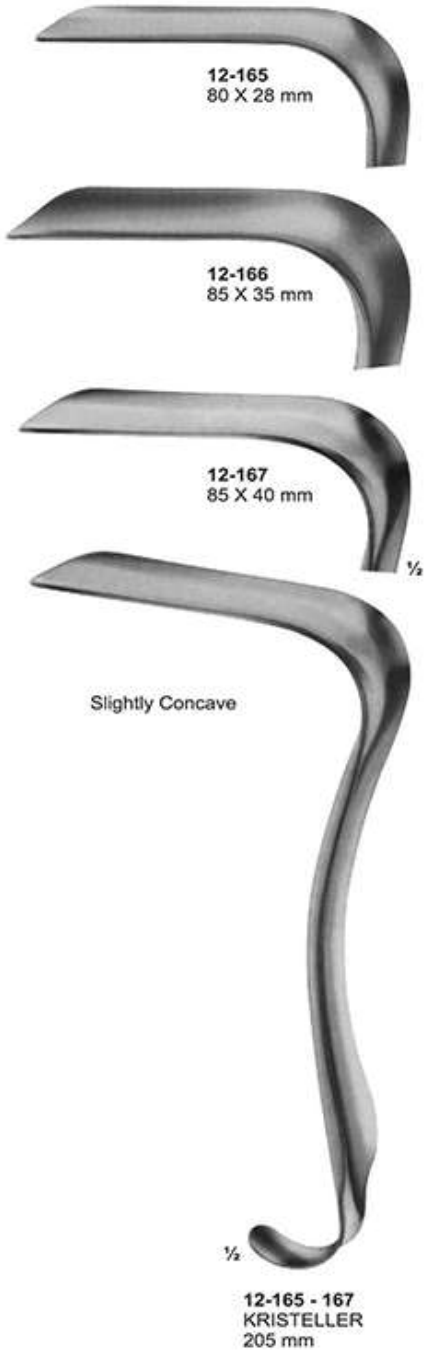

Vaginal Specula-upper and lower blades



Vaginal Specula-Sets, upper and lower blades

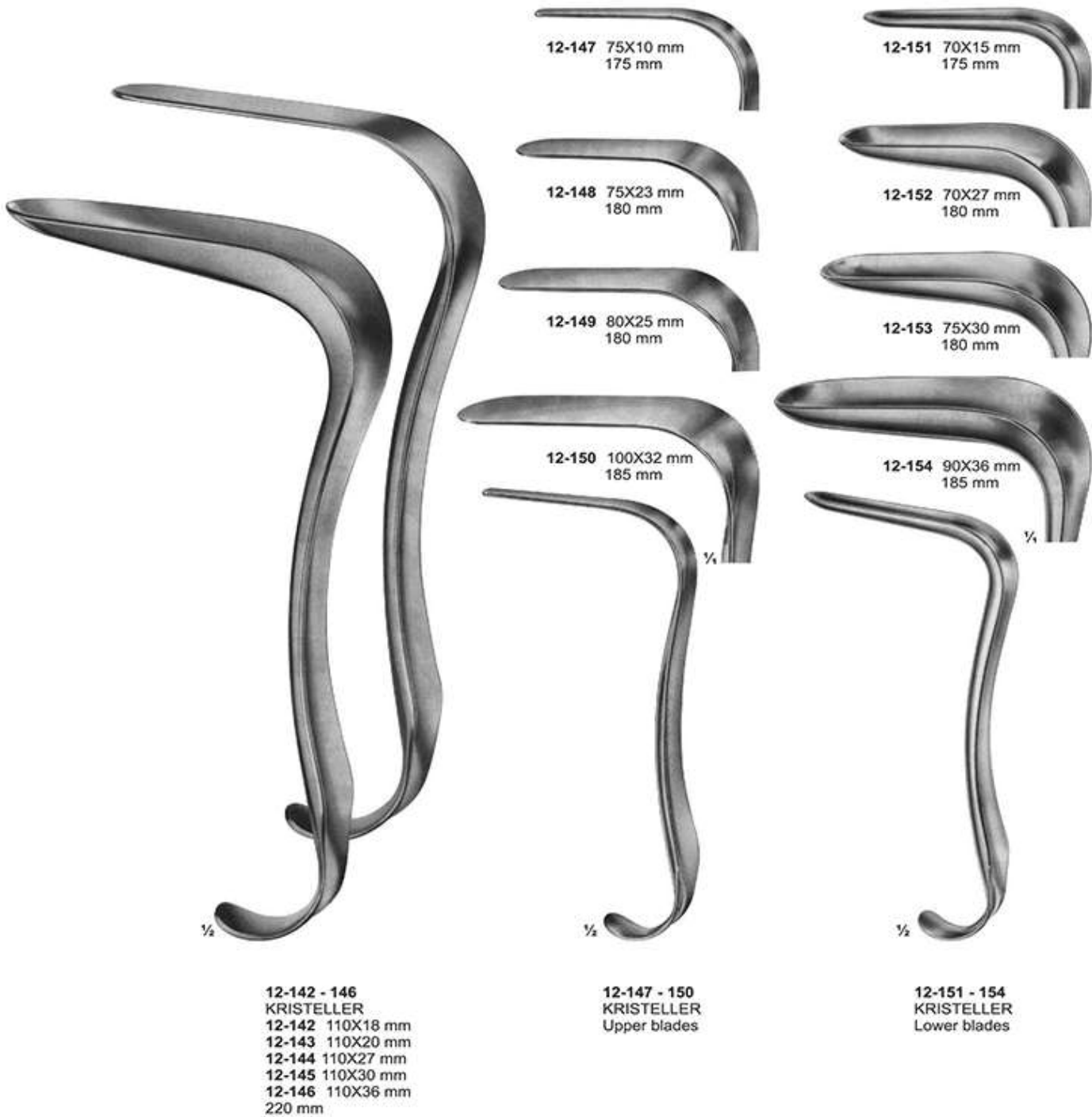

Vaginal Specula, Sets, Upper & Lower Blades

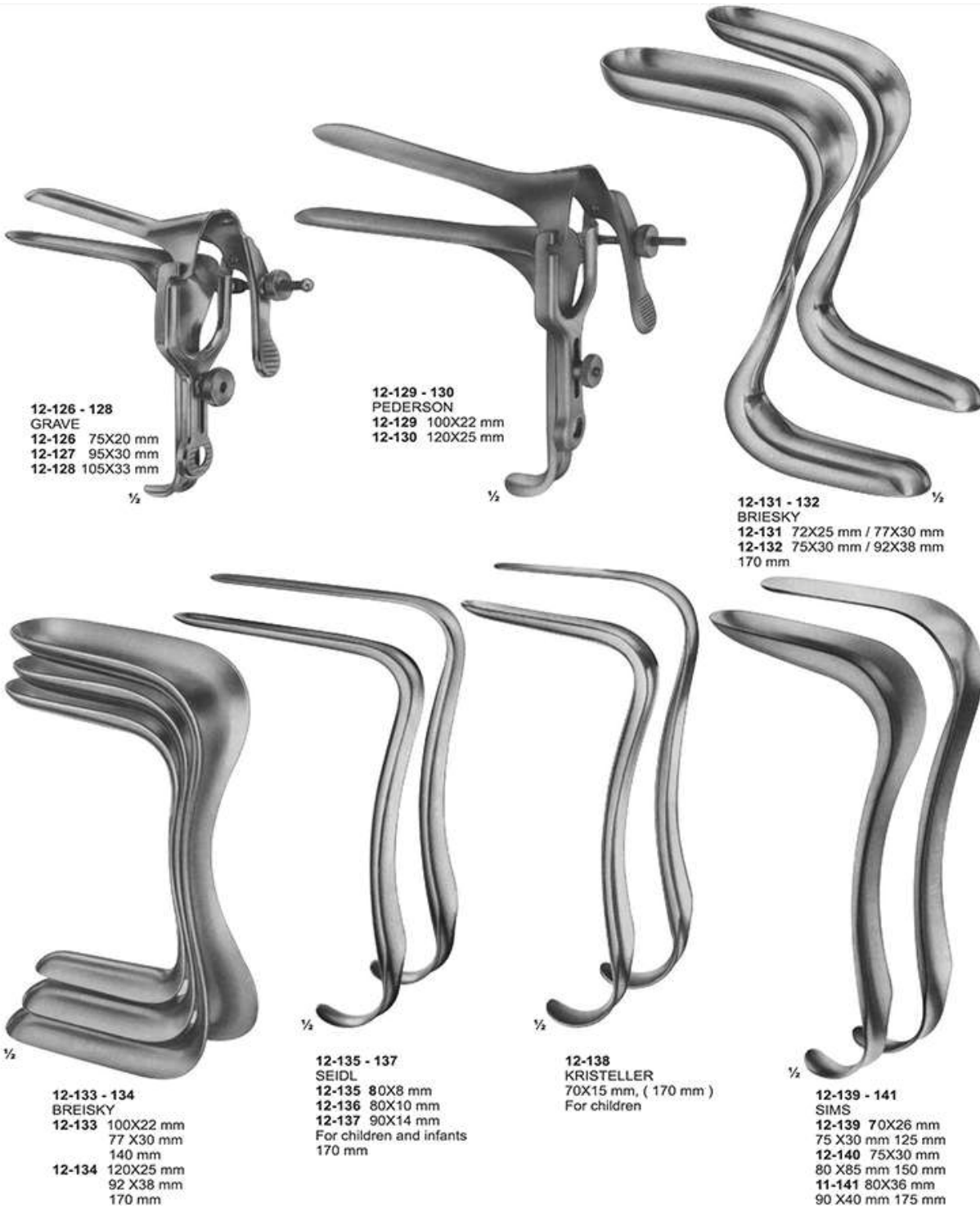

Vaginal Specula



1/2
12-112 - 115
CUSCO
STANDARD
12-112 80X24 mm
12-113 80X32 mm
12-114 90X36 mm
12-115 110X37 mm



1/2
12-116 - 119
CUSCO
12-116 80X24 mm
12-117 80X32 mm
12-118 90X36 mm
12-119 110X37 mm



1/2
12-120 - 122
CUSCO
12-120 80X24 mm
12-121 80X32 mm
12-122 115X36 mm



1/2
12-123 - 124
SEYFFERT
12-123 100X24 mm
12-124 110X32 mm
230 mm



1/2
12-125
SEMM
for children
and virgins
180 mm

Vaginal Specula

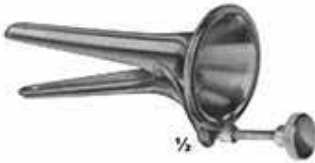

12-101
COLLIN
for children
53 x 10 mm

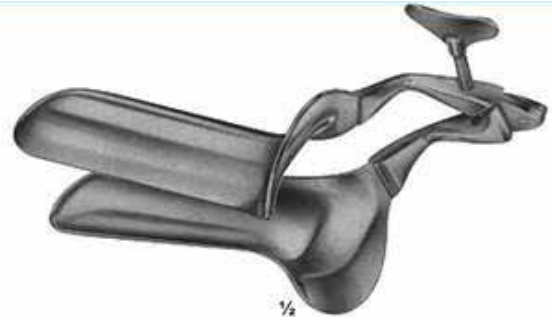

12-102 - 105
COLLIN

12-102	100/90mm	28 mm
12-103	100/90mm	32 mm
12-104	105/95mm	35 mm
12-105	115/105mm	40 mm

Total length/working length width



12-106
COLLIN
for virgins
95/85 x 18 mm



12-107
CUSCO
for virgins
75 x 17 mm



12-108
CUSCO
for virgins
75 x 17 mm



12-109 - 111
CUSCO

12-109	92X23-25 mm
12-110	100x25-27 mm
12-111	110x27-30 mm

Trocars



11-187
KLIMA ROSEGGER
35 X 1,8 mm
Sternal puncture needle

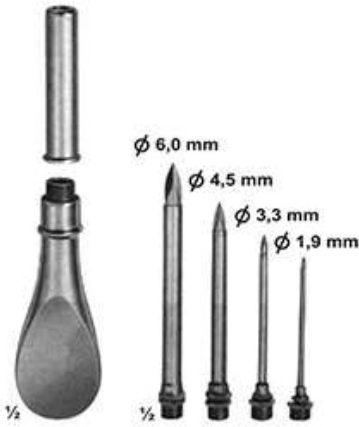

11-188
Universal trocar
with 4 tips



11-189 - 193
Inside dime, Outside dime
11-189 2,2 mm 3,0 mm
11-190 3,0 mm 4,0 mm
11-191 4,0 mm 5,0 mm
11-192 5,0 mm 6,0 mm
11-193 5,5 mm 6,5 mm
for hydrocele and abdominal puncture



11-194 - 197
Inside dime, Outside dime
11-194 2,2 mm 3,0 mm
11-195 3,0 mm 4,0 mm
11-196 4,0 mm 5,0 mm
11-197 5,0 mm 6,0 mm
for abdominal puncture,
with stop-cock and lateral drain



11-198 - 199
Inside dime, Outside dime
11-198 6,5 mm 8,0 mm
11-199 9,0 mm 10,0 mm
Empyema trocar



11-200 - 203
Inside dime, Outside dime
11-200 3,0 mm 4,0 mm
11-201 3,6 mm 4,6 mm
11-202 4,3 mm 5,3 mm
11-203 5,0 mm 6,0 mm
Gall bladder trocars



11-204
PIERCE
Antrum trocar
4,0 mm



11-205
COAKLEY
Antrum trocar
3,0 mm

Genito-Urinary Instruments & Circumcision Clamps



11-185
GUYON
Set of urethral bougies and dilating sounds,
in metal case, with lift out rack and bottom
rack, containing 21 urethral and dilating sounds.



11-186
WINKELMANN
Circumcision Clamps
12 mm / 16 mm / 20 mm

Genito-Urinary Instruments



11-111
GUYON
Catheter guide
(introducer)
365 mm

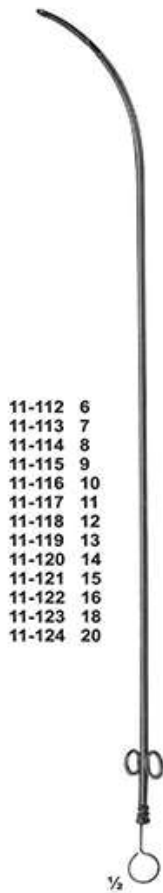

- 11-112 6
- 11-113 7
- 11-114 8
- 11-115 9
- 11-116 10
- 11-117 11
- 11-118 12
- 11-119 13
- 11-120 14
- 11-121 15
- 11-122 16
- 11-123 18
- 11-124 20

11-112 - 124
Female catheters,
metal
160 mm

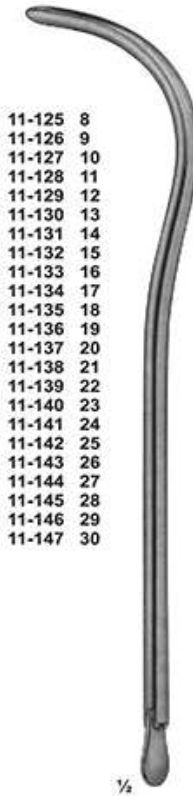

- 11-125 8
- 11-126 9
- 11-127 10
- 11-128 11
- 11-129 12
- 11-130 13
- 11-131 14
- 11-132 15
- 11-133 16
- 11-134 17
- 11-135 18
- 11-136 19
- 11-137 20
- 11-138 21
- 11-139 22
- 11-140 23
- 11-141 24
- 11-142 25
- 11-143 26
- 11-144 27
- 11-145 28
- 11-146 29
- 11-147 30

11-125 - 147
Urethral bougies
and dilating sounds
345 mm

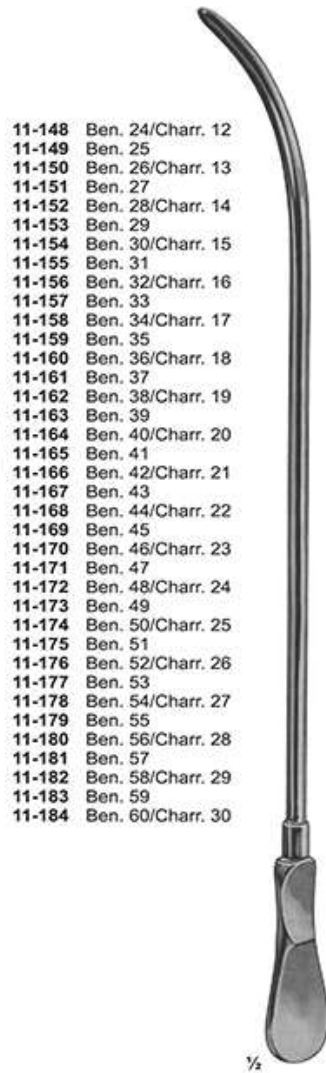

- 11-148 Ben. 24/Charr. 12
- 11-149 Ben. 25
- 11-150 Ben. 26/Charr. 13
- 11-151 Ben. 27
- 11-152 Ben. 28/Charr. 14
- 11-153 Ben. 29
- 11-154 Ben. 30/Charr. 15
- 11-155 Ben. 31
- 11-156 Ben. 32/Charr. 16
- 11-157 Ben. 33
- 11-158 Ben. 34/Charr. 17
- 11-159 Ben. 35
- 11-160 Ben. 36/Charr. 18
- 11-161 Ben. 37
- 11-162 Ben. 38/Charr. 19
- 11-163 Ben. 39
- 11-164 Ben. 40/Charr. 20
- 11-165 Ben. 41
- 11-166 Ben. 42/Charr. 21
- 11-167 Ben. 43
- 11-168 Ben. 44/Charr. 22
- 11-169 Ben. 45
- 11-170 Ben. 46/Charr. 23
- 11-171 Ben. 47
- 11-172 Ben. 48/Charr. 24
- 11-173 Ben. 49
- 11-174 Ben. 50/Charr. 25
- 11-175 Ben. 51
- 11-176 Ben. 52/Charr. 26
- 11-177 Ben. 53
- 11-178 Ben. 54/Charr. 27
- 11-179 Ben. 55
- 11-180 Ben. 56/Charr. 28
- 11-181 Ben. 57
- 11-182 Ben. 58/Charr. 29
- 11-183 Ben. 59
- 11-184 Ben. 60/Charr. 30

11-148 - 184
Urethral bougies
and dilating sounds
255 mm

Genito-Urinary Instruments-Prostatectomy



11-106
MATHIEU
Foreign body forceps
Length of shaft
190 mm



11-107
MILLIN
Lobe grasping
forceps
245 mm



11-108
MILLIN
Lobe grasping
forceps
235 mm



11-109
MILLIN
Bladder neck spreader
285 mm



11-110
Ureter forceps
240 mm

Bladder Retractors

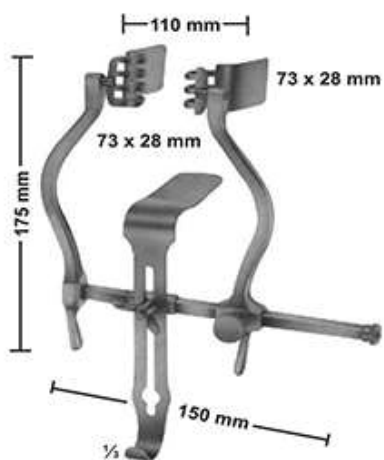

11-101
JUDD-MASSON
Bladder and suprapubic
retractor



11-102
MILLIN
Bladder retractor
105X45 mm



11-103
LEGUEU
Bladder retractor
Center blade
80 x 31 mm

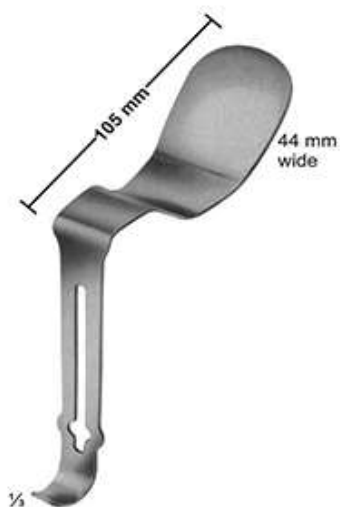

11-104
MILLIN
Center bladder for
retro pubic prostatectomy



11-105
KOCHER
Bladder spatula
235 mm

Kidney Stone Forceps

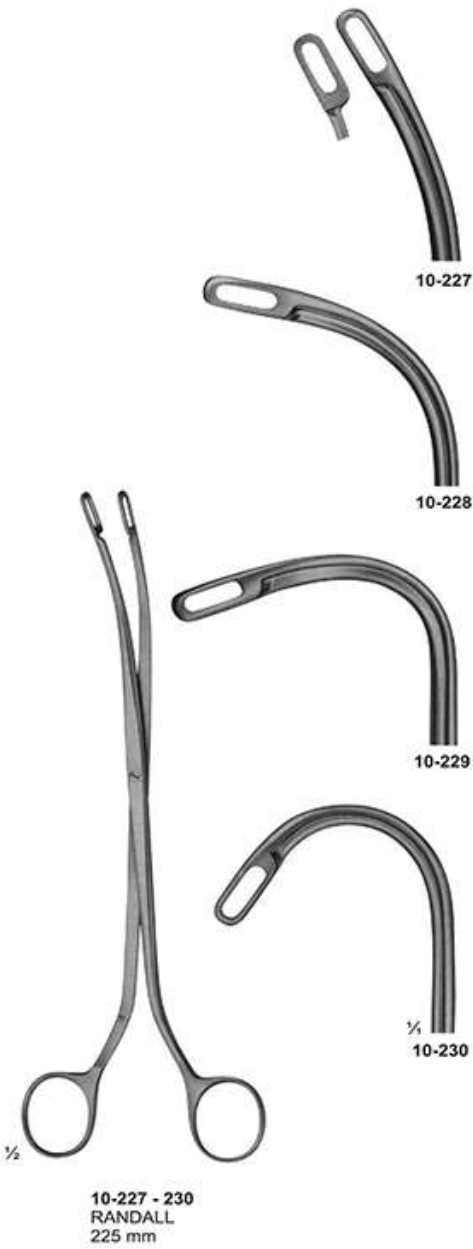

Kidney Elevating Forceps



10-225
COLLIN
285 mm



10-226
DARTIGUES
255 mm

Kidney Clamps

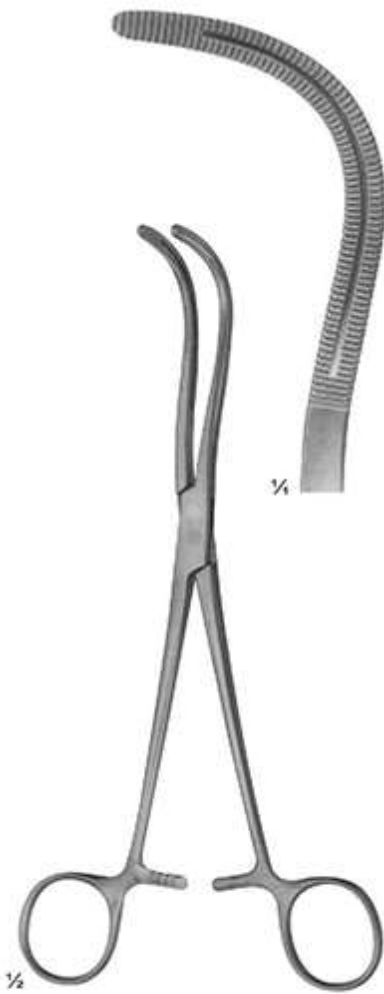

10-222
STILLE
220 mm

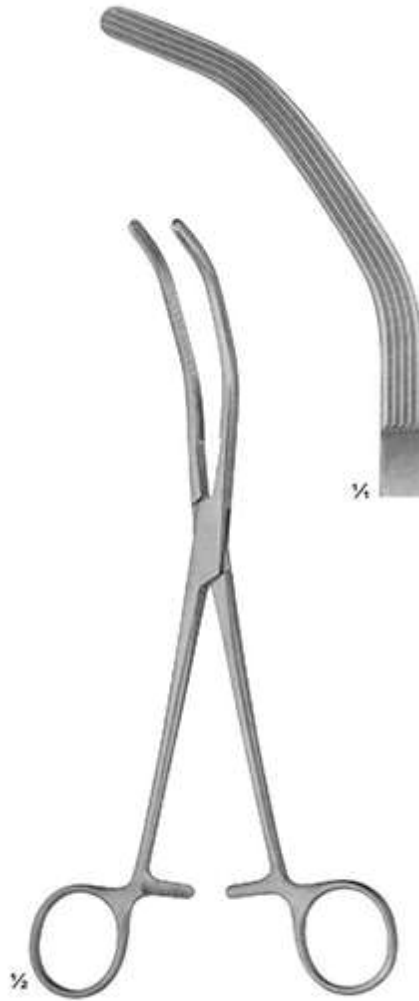

10-223
HERRICK
225 mm

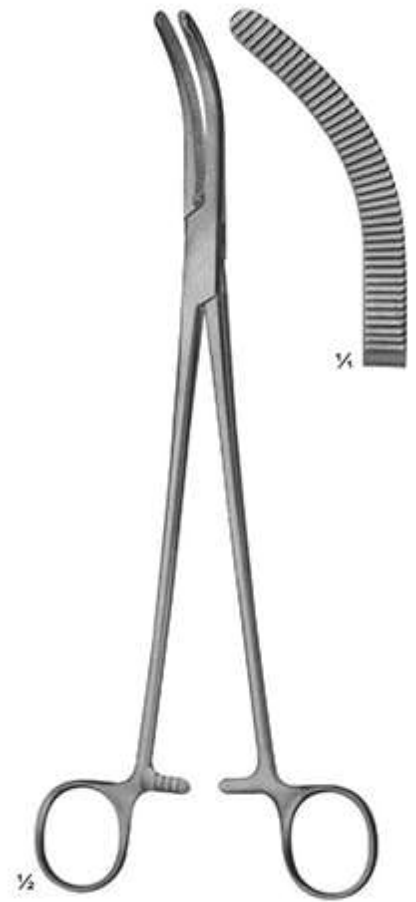

10-224
WERTHEIM
225 mm

Kidney Clamps

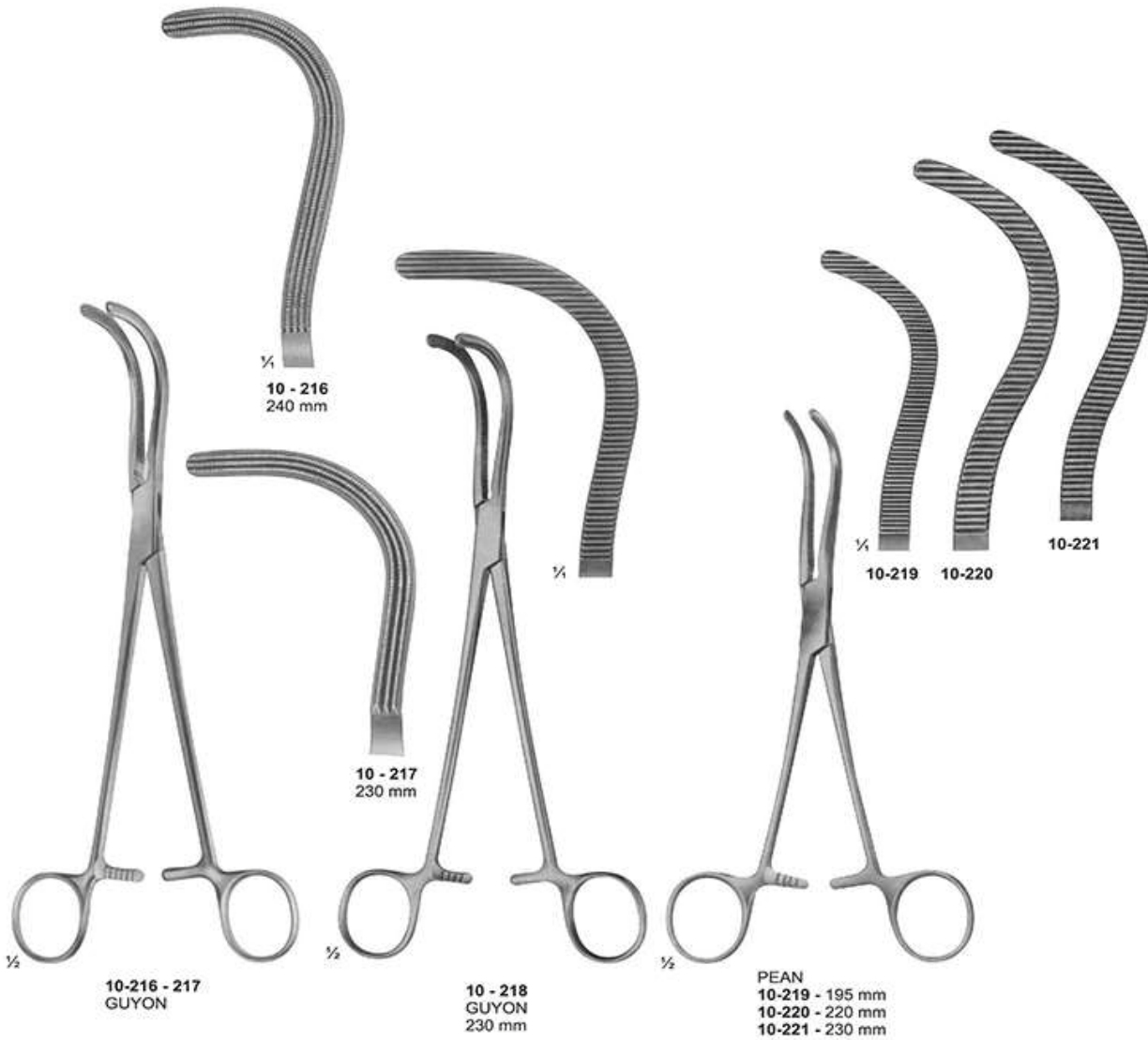

Gall Stone Forceps

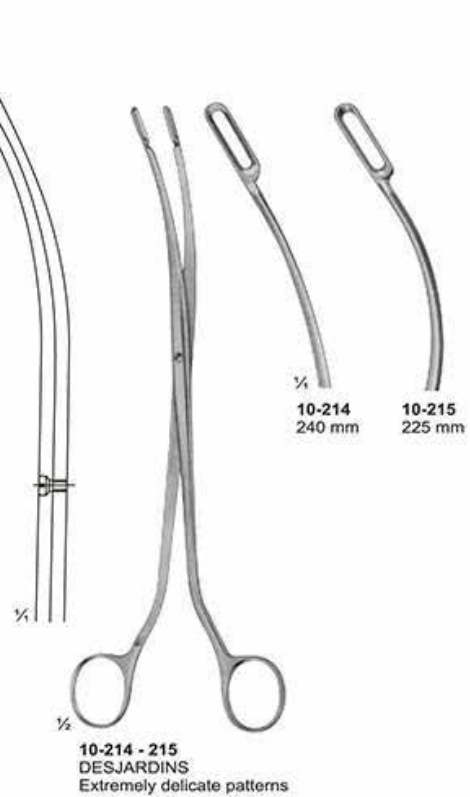
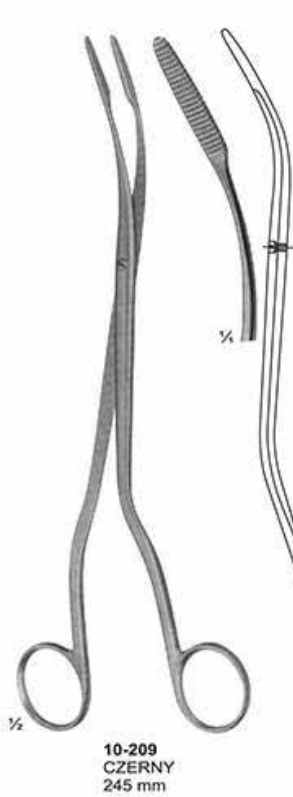
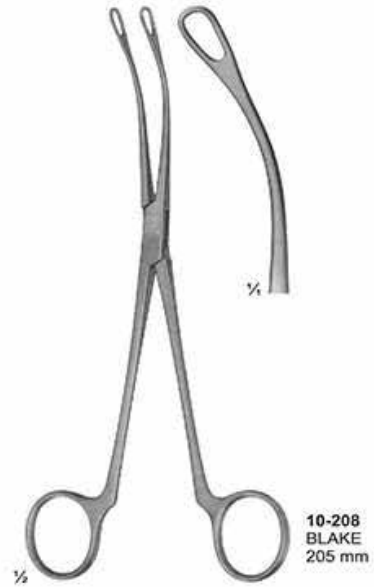
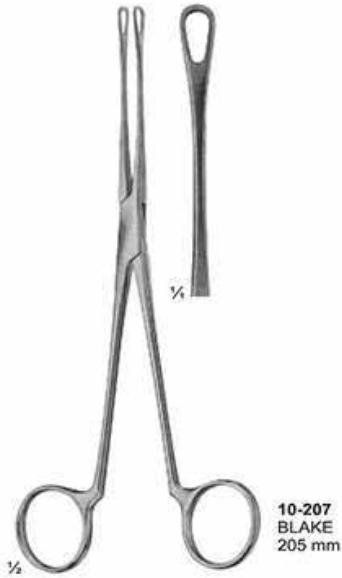

Gall Duct Dilators & Gall Stone Scoops

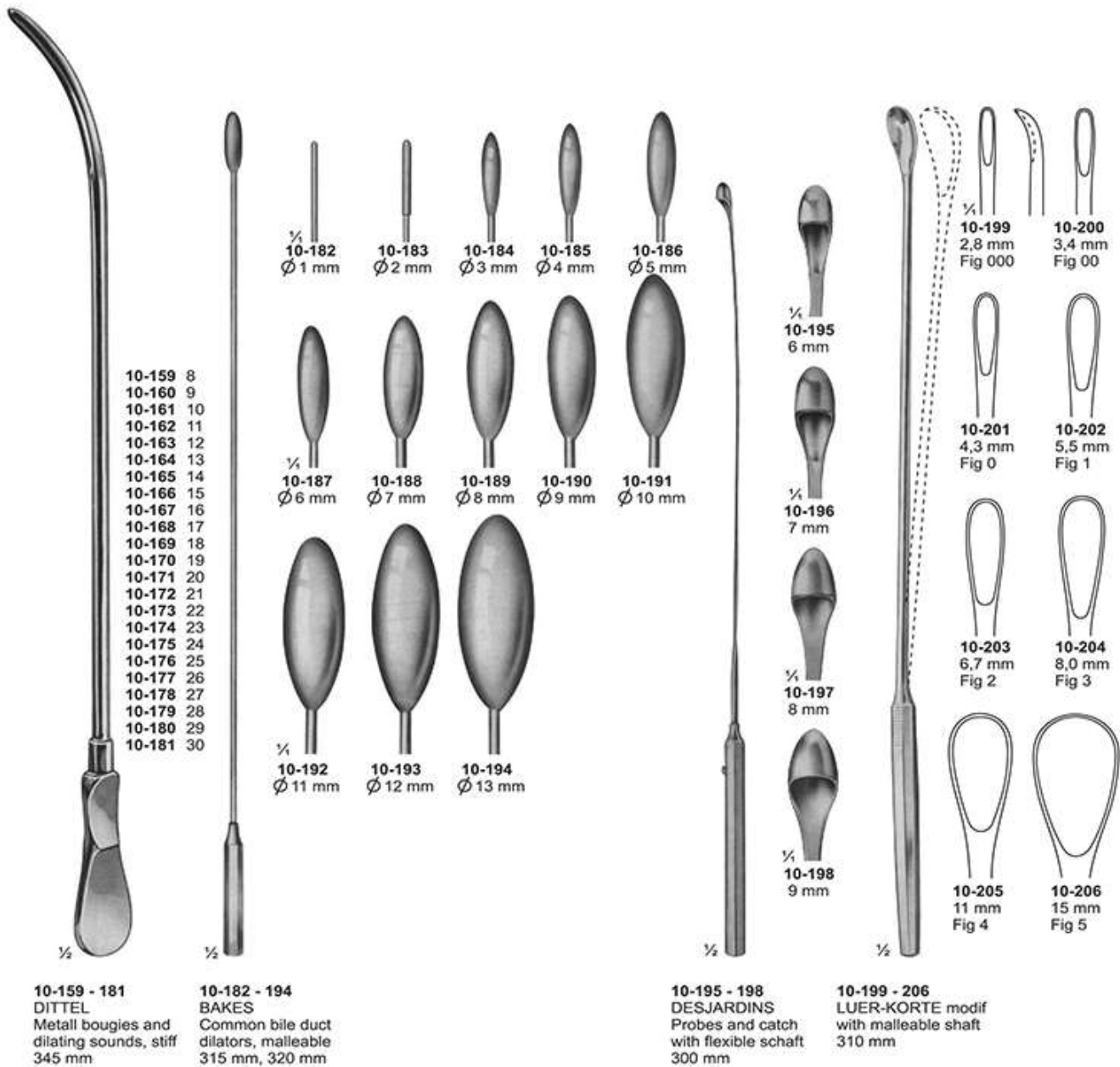

Gall Ducts Probes

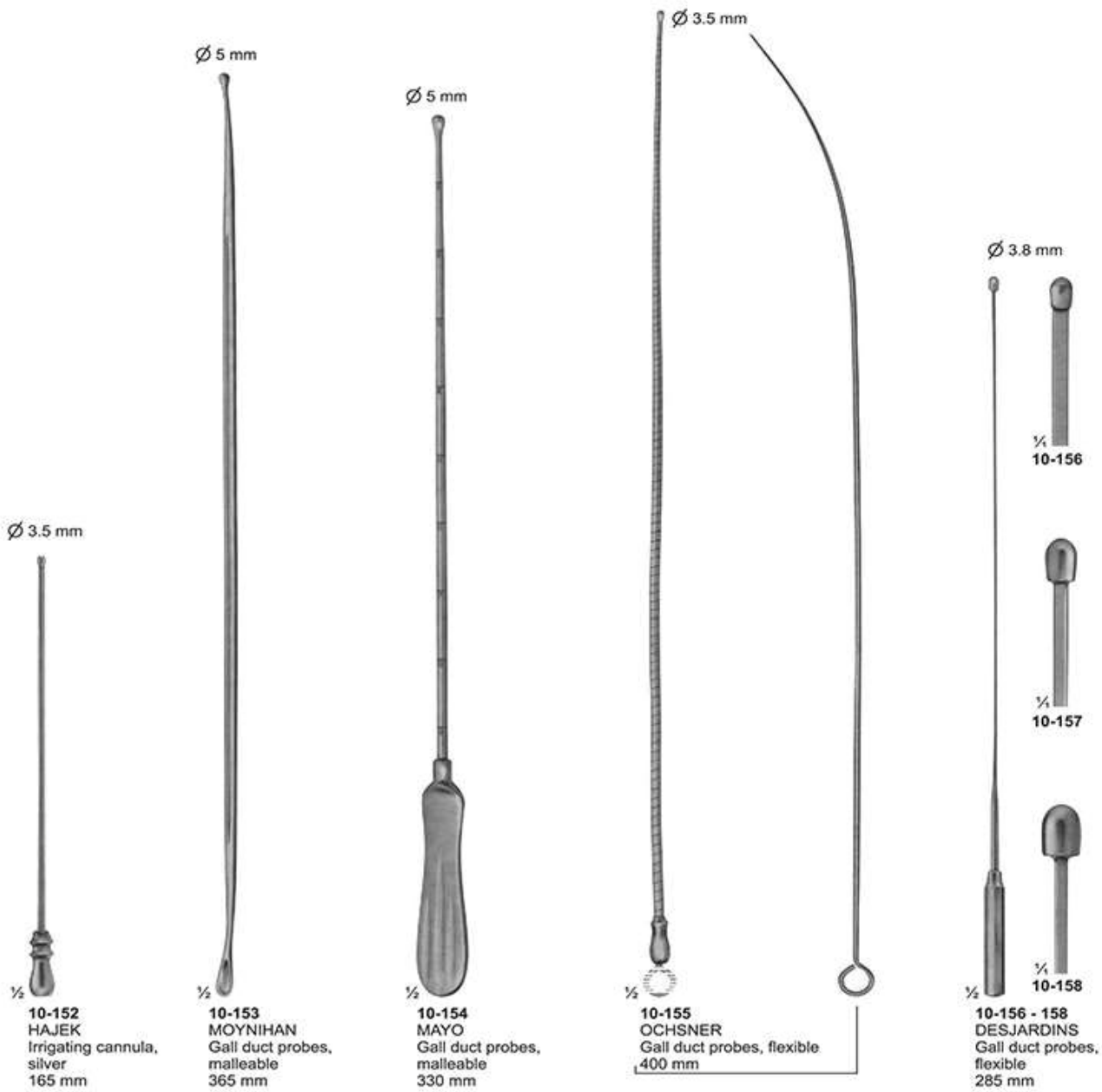

Gall Bladder Forceps and Gall Duct Scissors

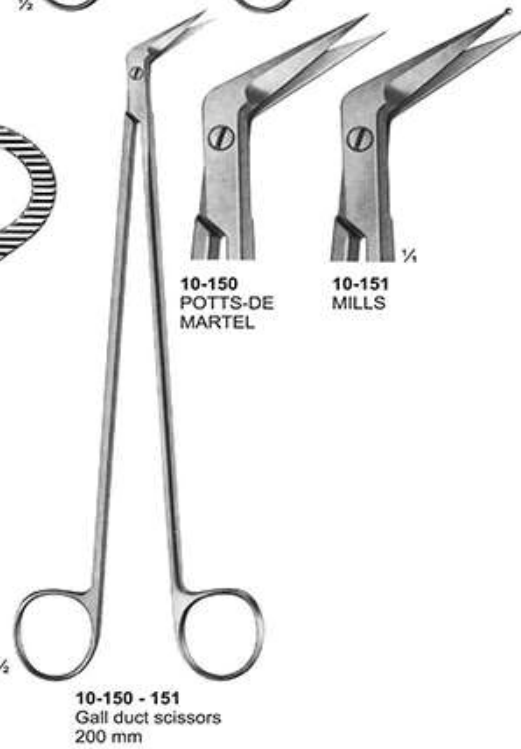
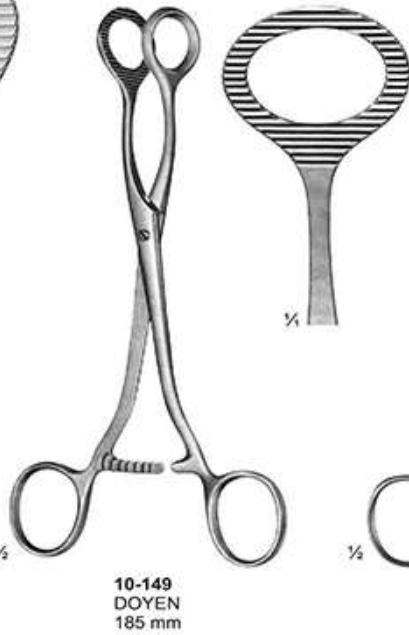
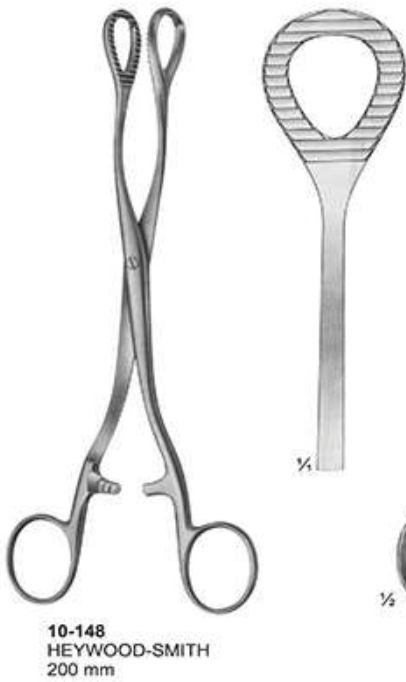
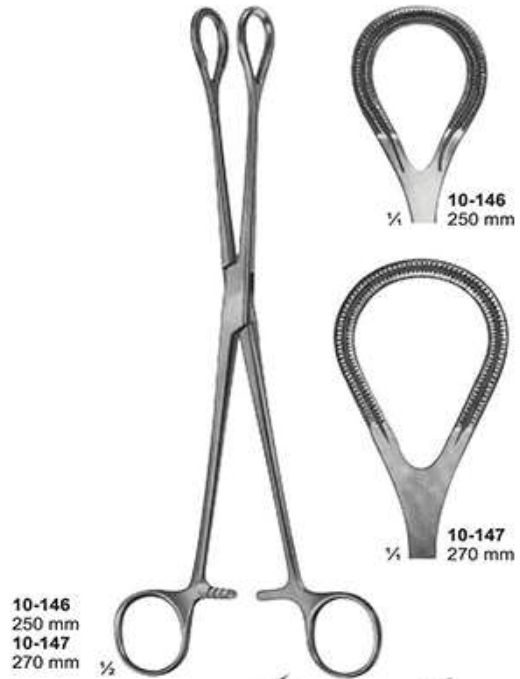
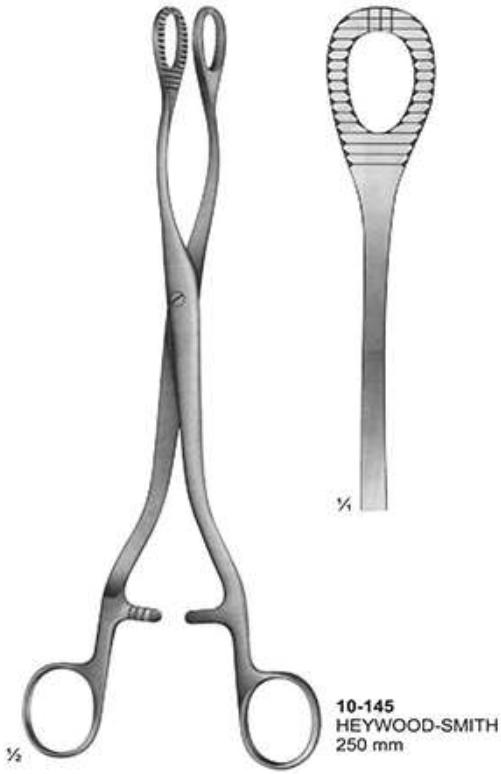

Gall Duct Forceps and Choledochus Forceps

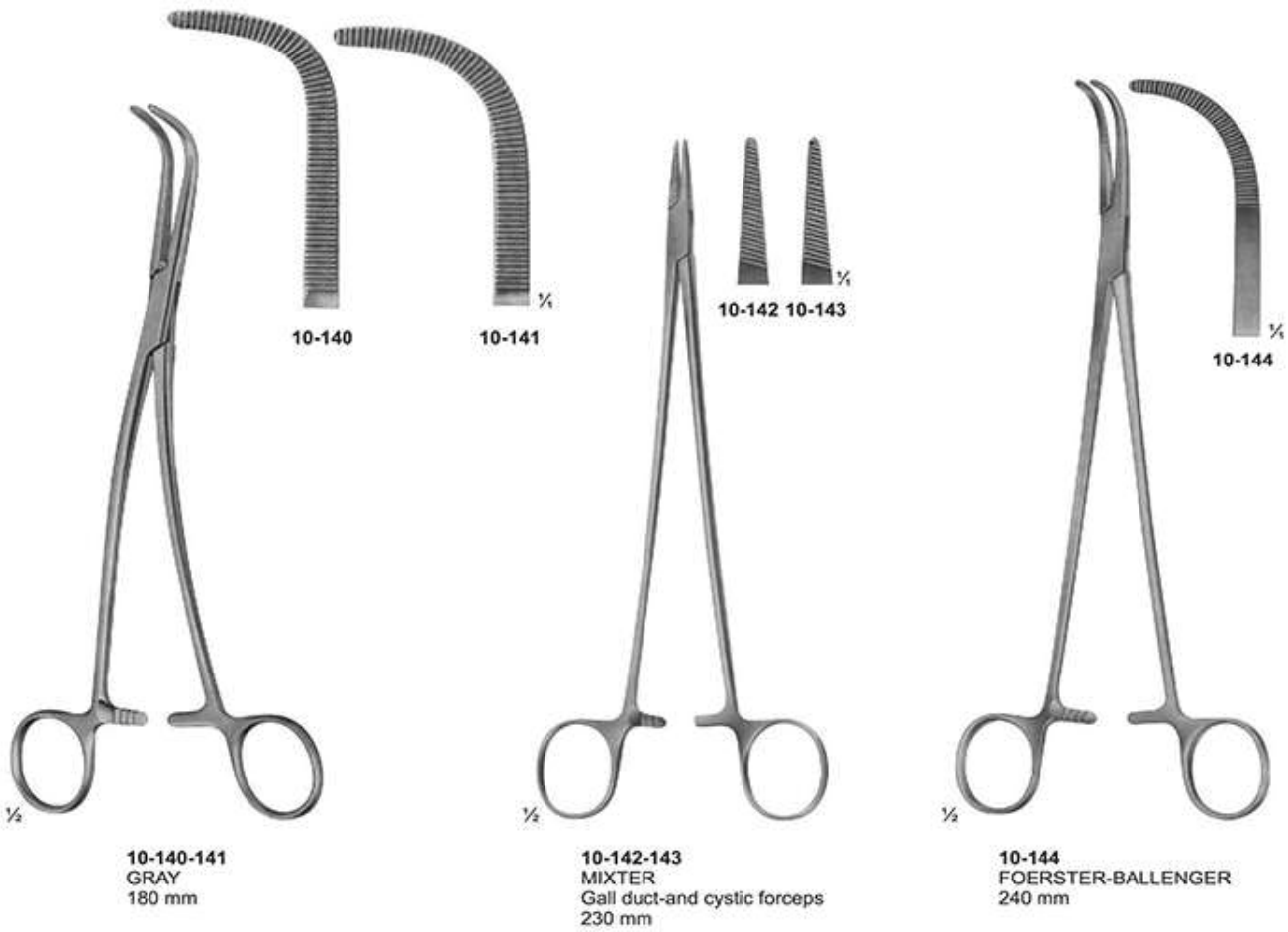

Gall Duct Forceps



10-135
LOWER
180 mm



10-136
LAHEY (SWEET)
190 mm



10-137
LAHEY
220 mm



10-138
DESJARDINS
Gall duct-and cystic forceps
210 mm

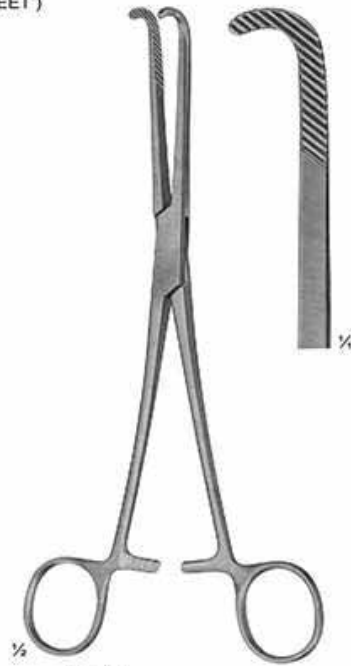

10-139
NISSEN
Gall duct-and cystic forceps
215 mm

Haemorrhoidal Forceps

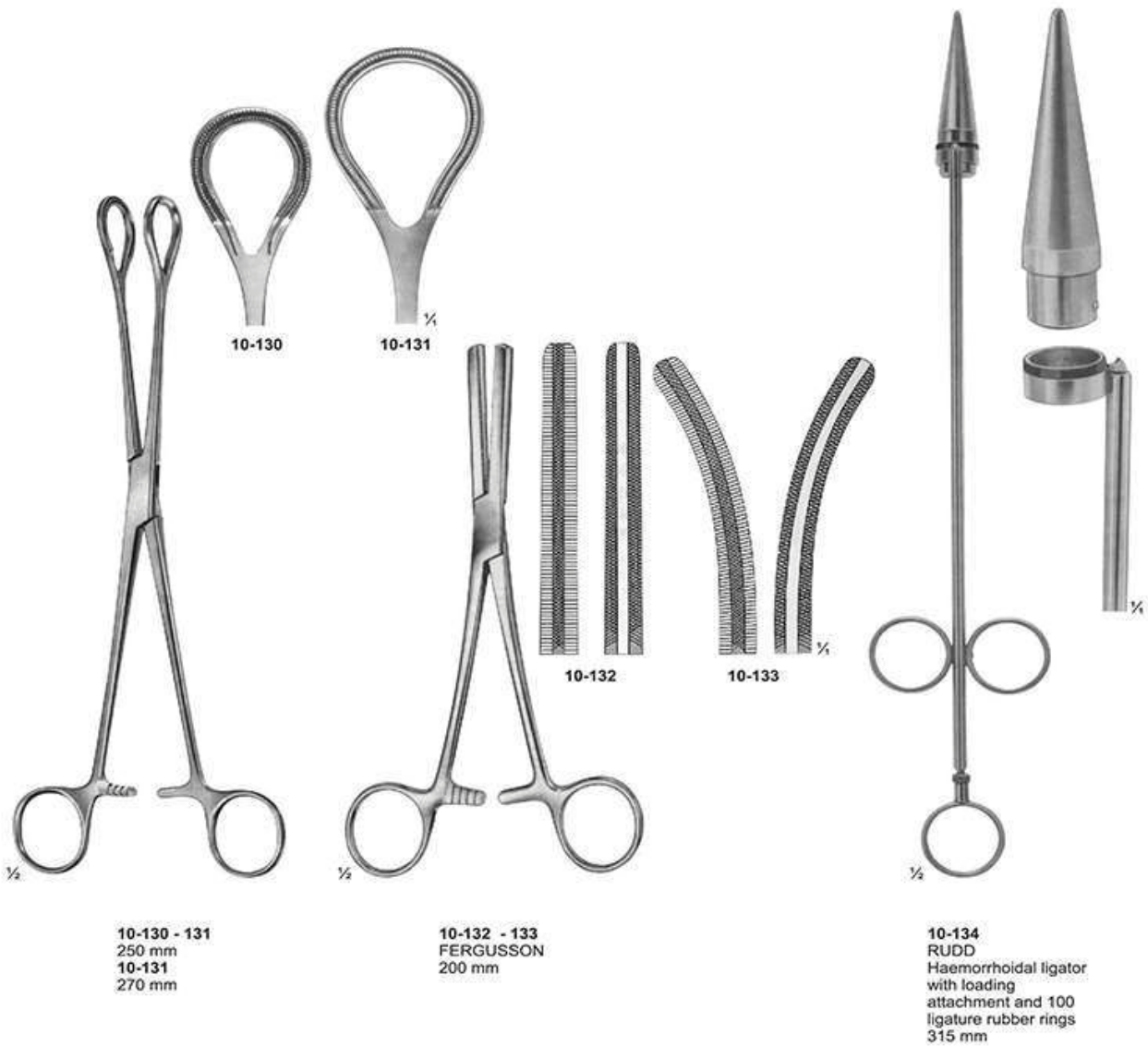

Haemorrhoidal Forceps



Biopsy Forceps & Swab Holders

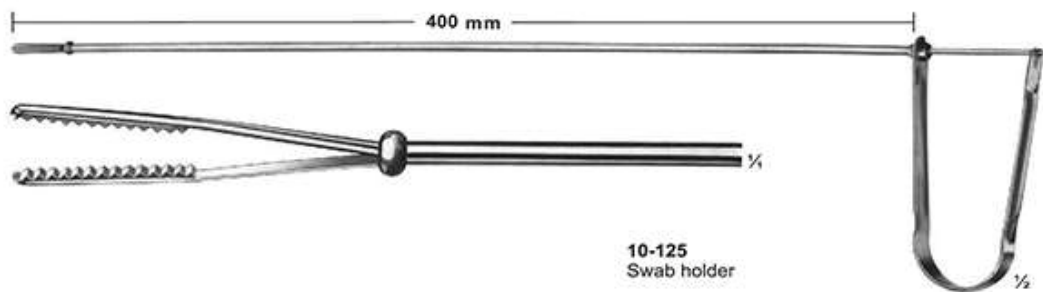
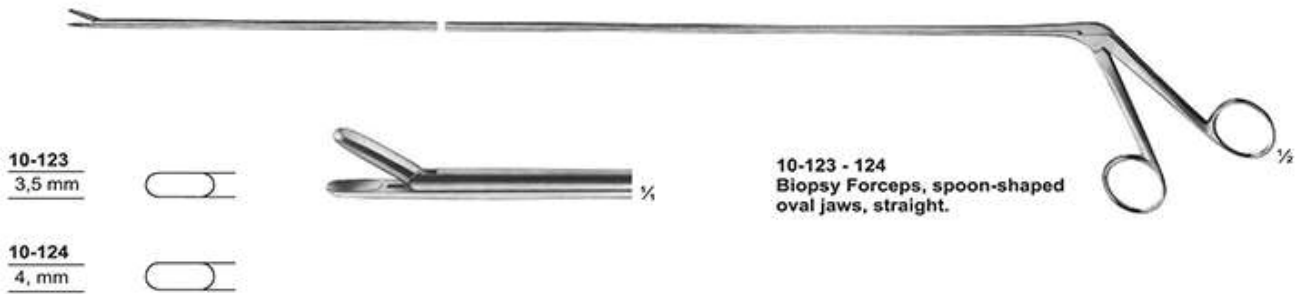
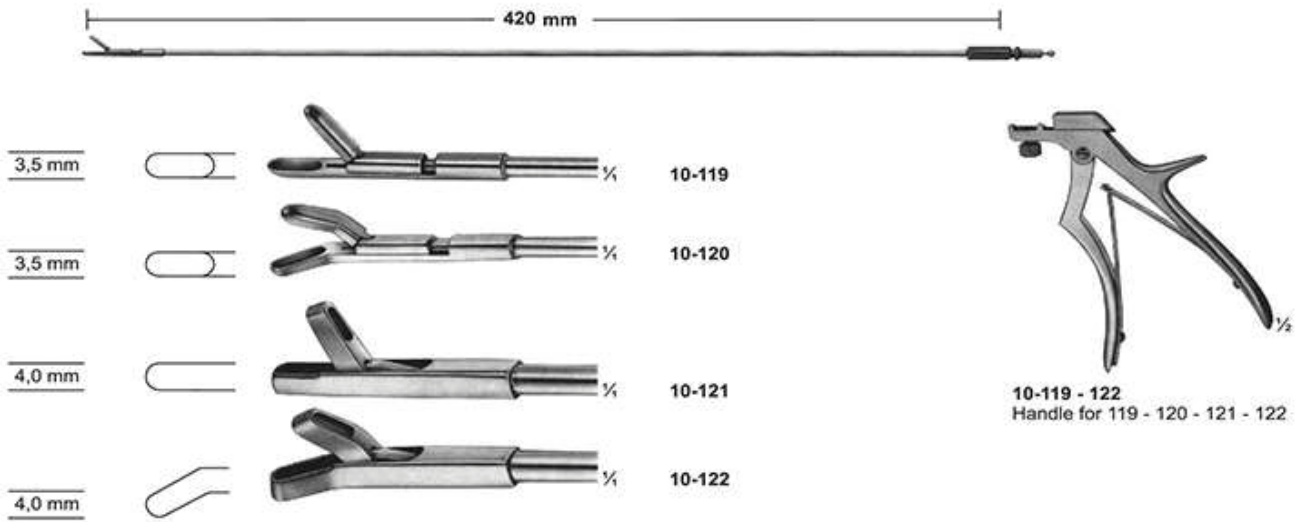

Biopsy forceps for rectum

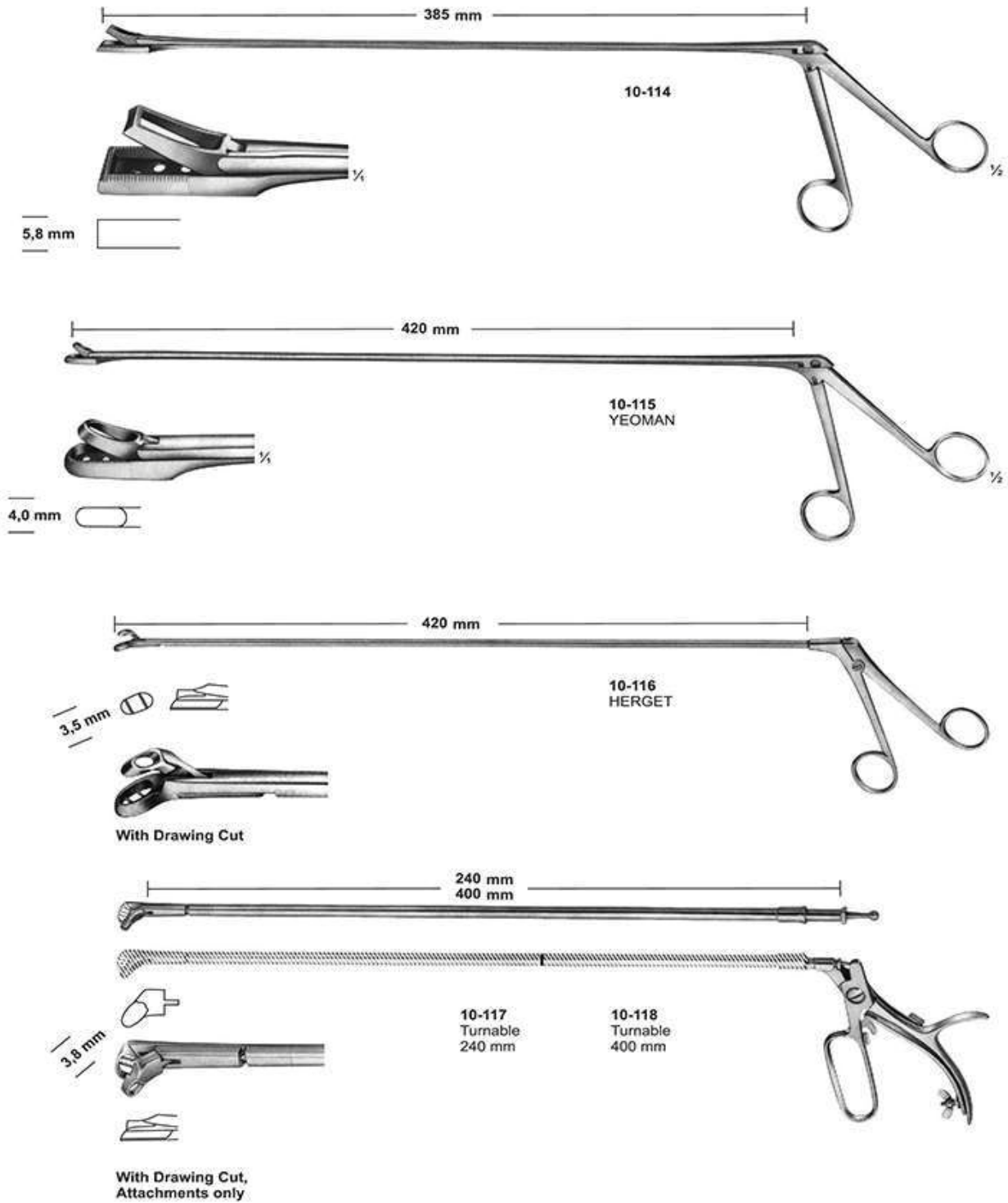

Anuscopy-Sphincteroscopes



10-110
IVES-FANSLER
Anuscopy
145 mm



10-111
KELLY
Sphincteroscope
160 mm



10-112
KELLY
Sphincteroscope
160 mm

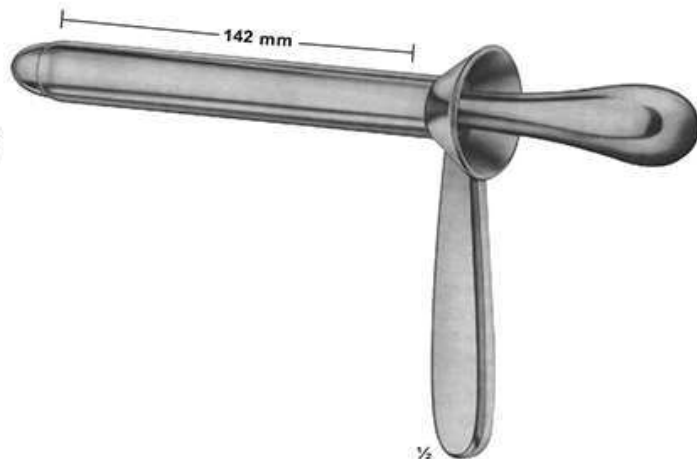

10-113
KELLY
Proctoscope
160 mm

Rectal Specula

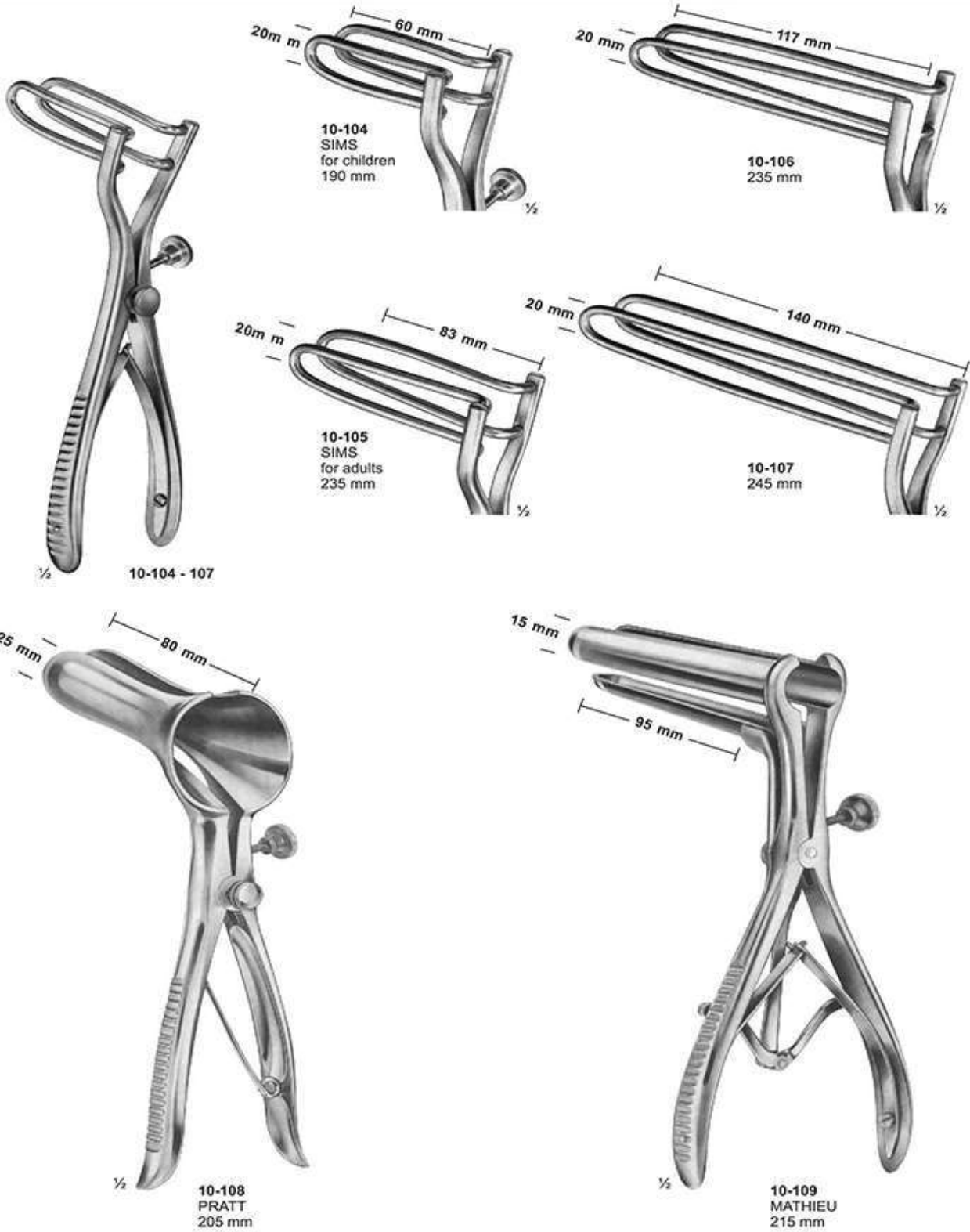

Rectal Specula

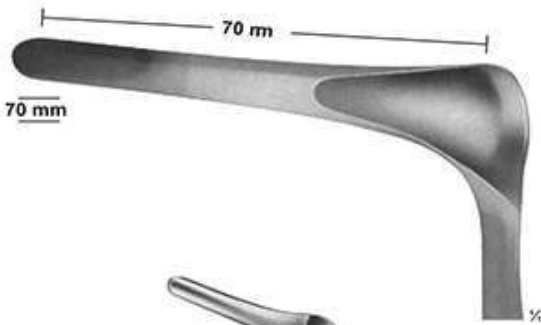

10-101
KILLIAN
for children
145 mm



10-102
SIMS
160 mm



10-103
SIMS
160 mm

Sigmoid Anastomosis Forceps



Sigmoid Anastomosis Forceps

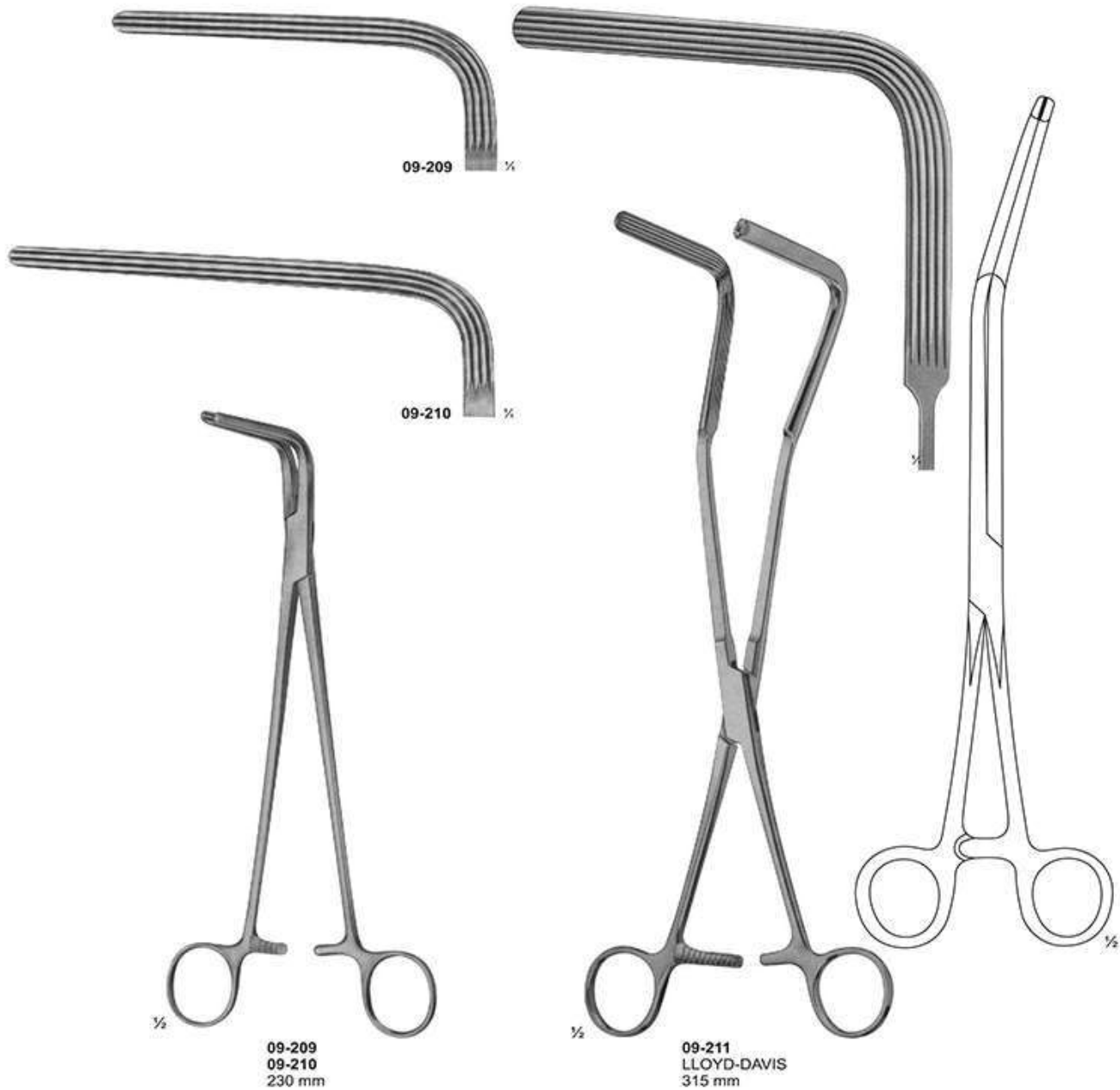

Anastomosis Forceps

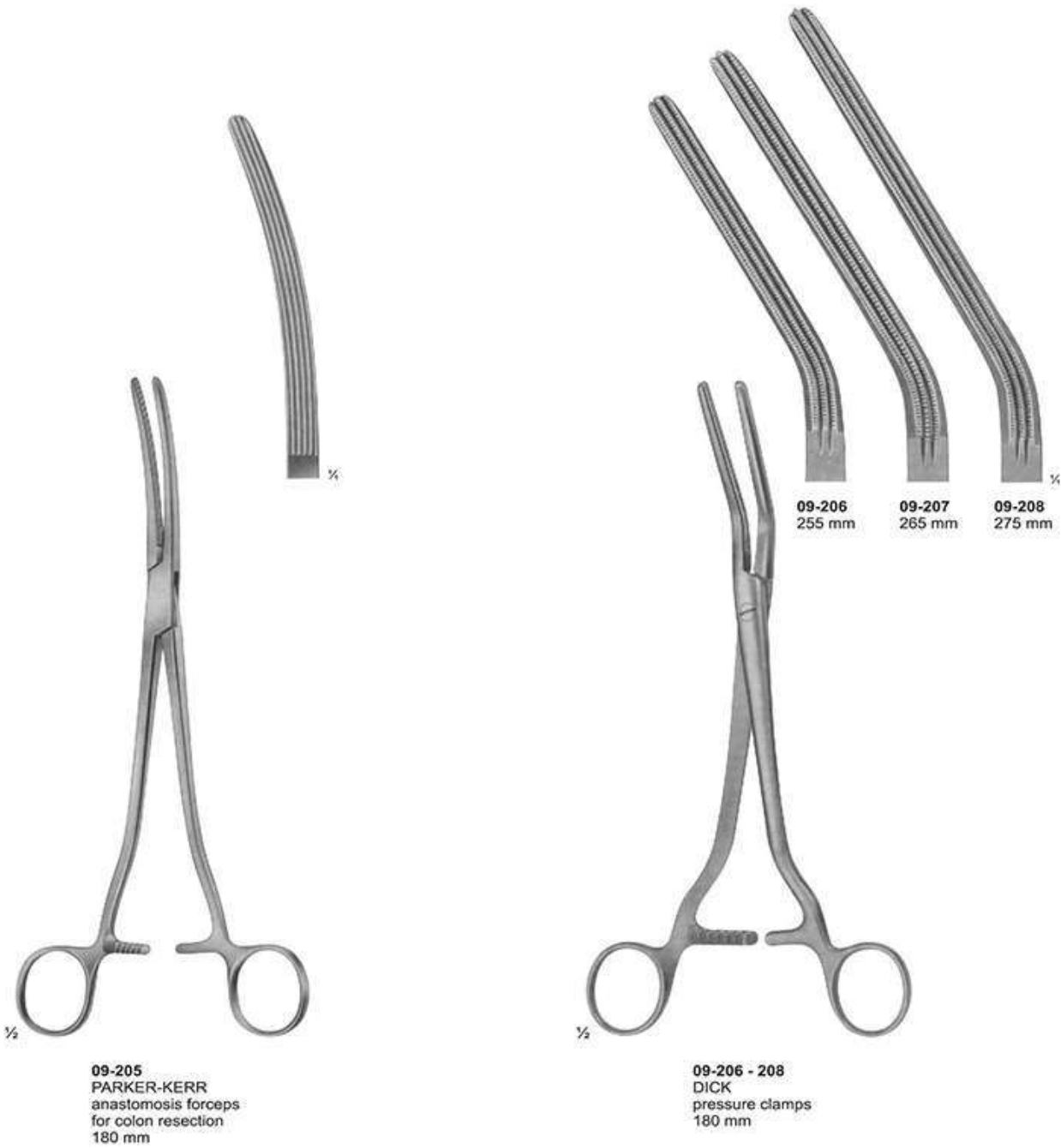

Intestinal and Pylorus Clamps



Stomach Clamps

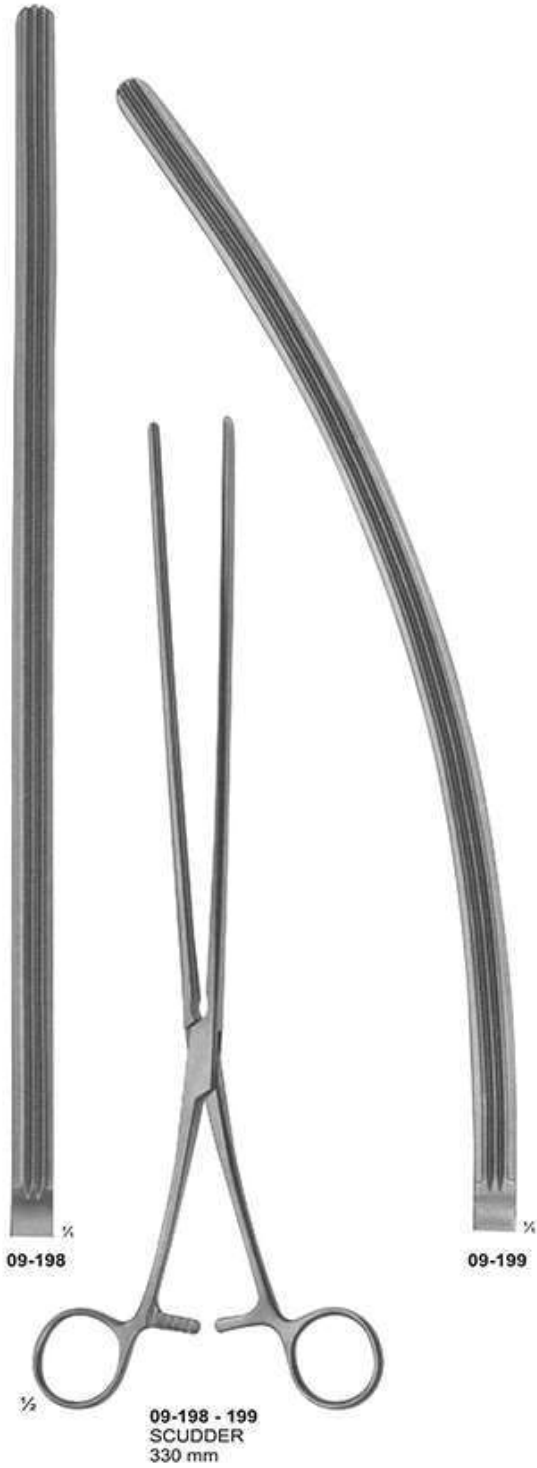

Gastro-Intestinal Forceps, twin



Intestinal Clamps

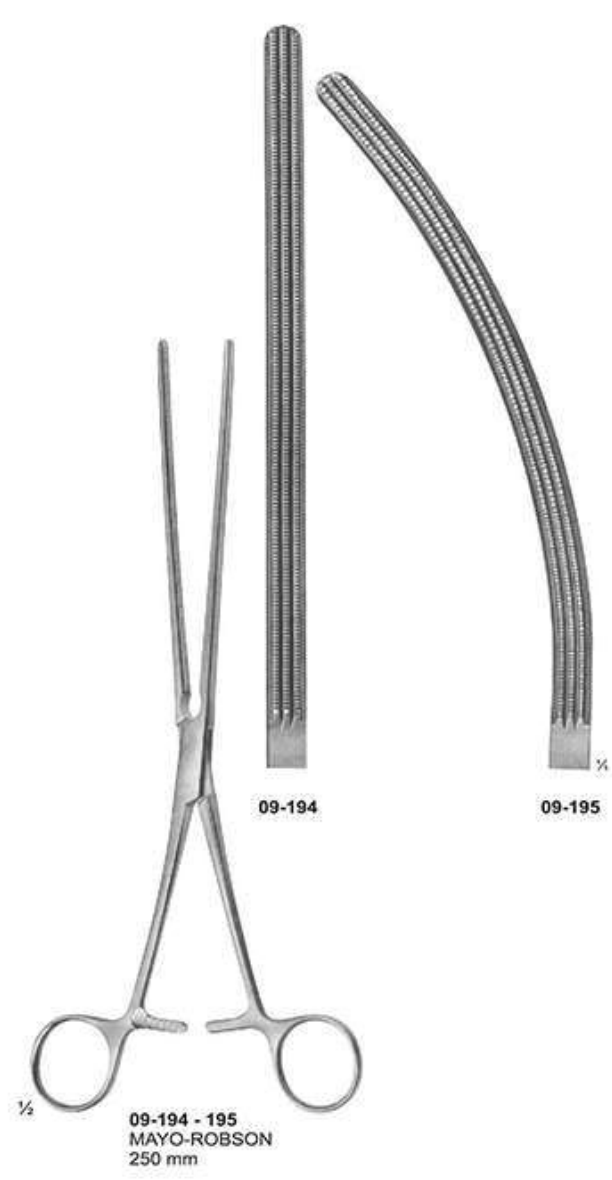
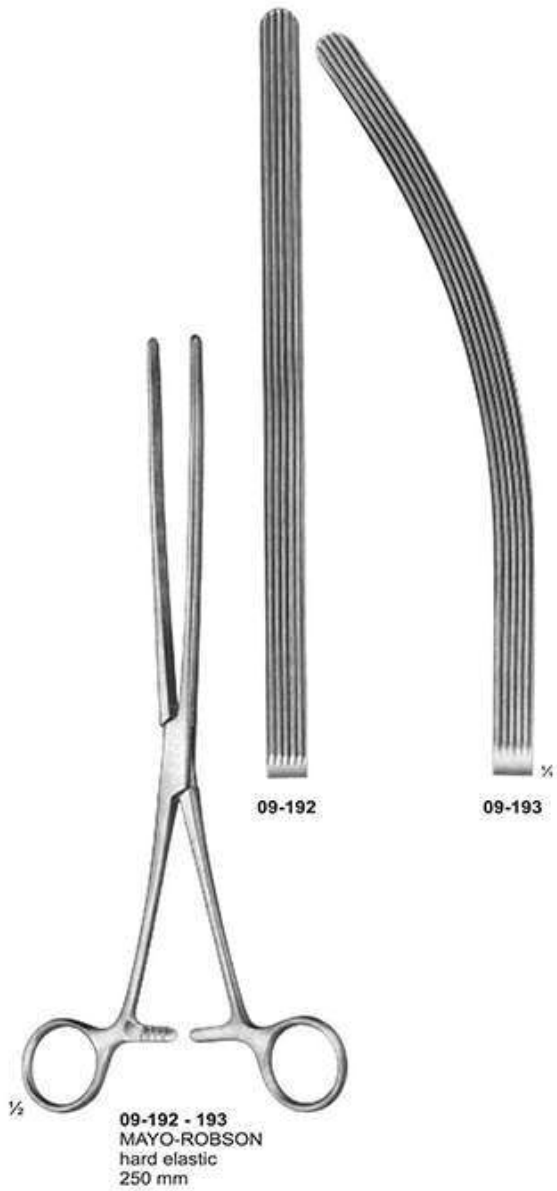

Intestinal Clamps

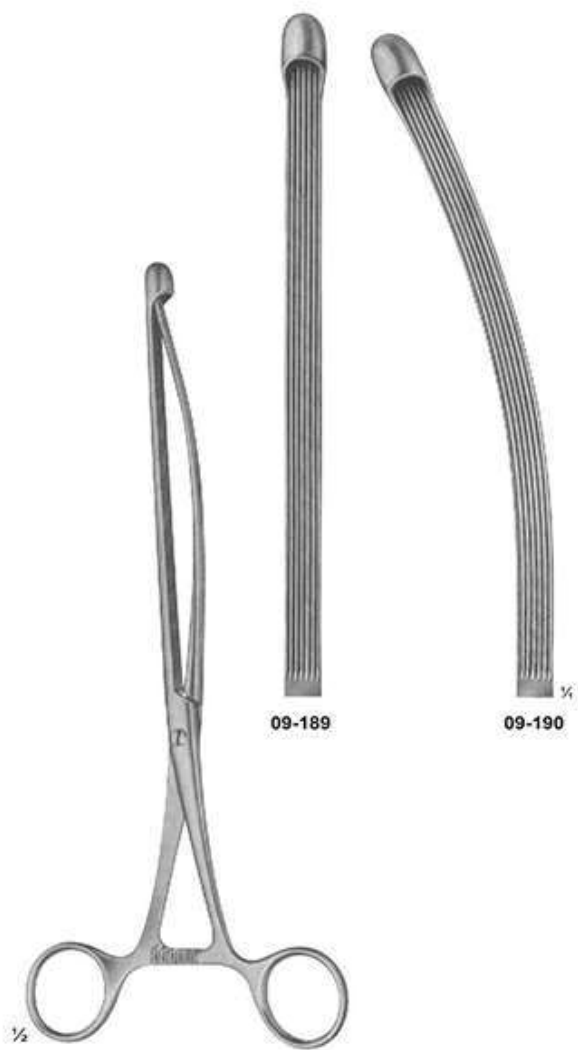

09-189 - 190
NUSSBAUM
with elastic blades
250 mm

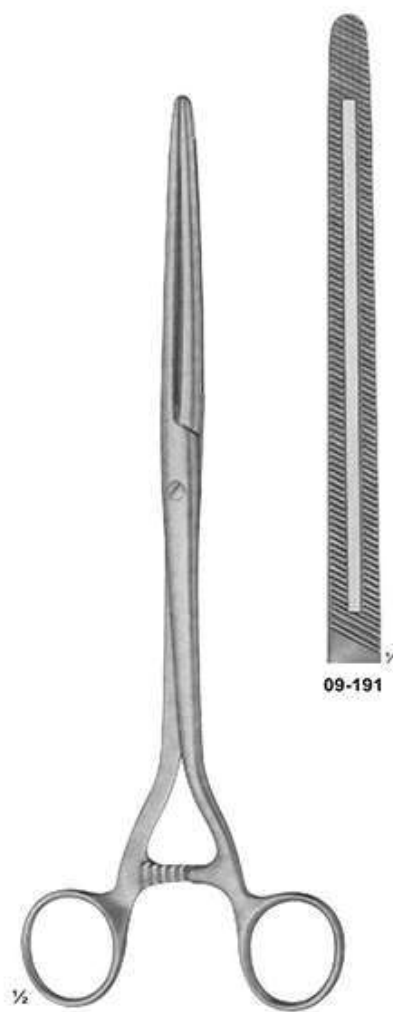

09-191
MOYNIHAN
280 mm

Intestinal Clamps, Soft elastic

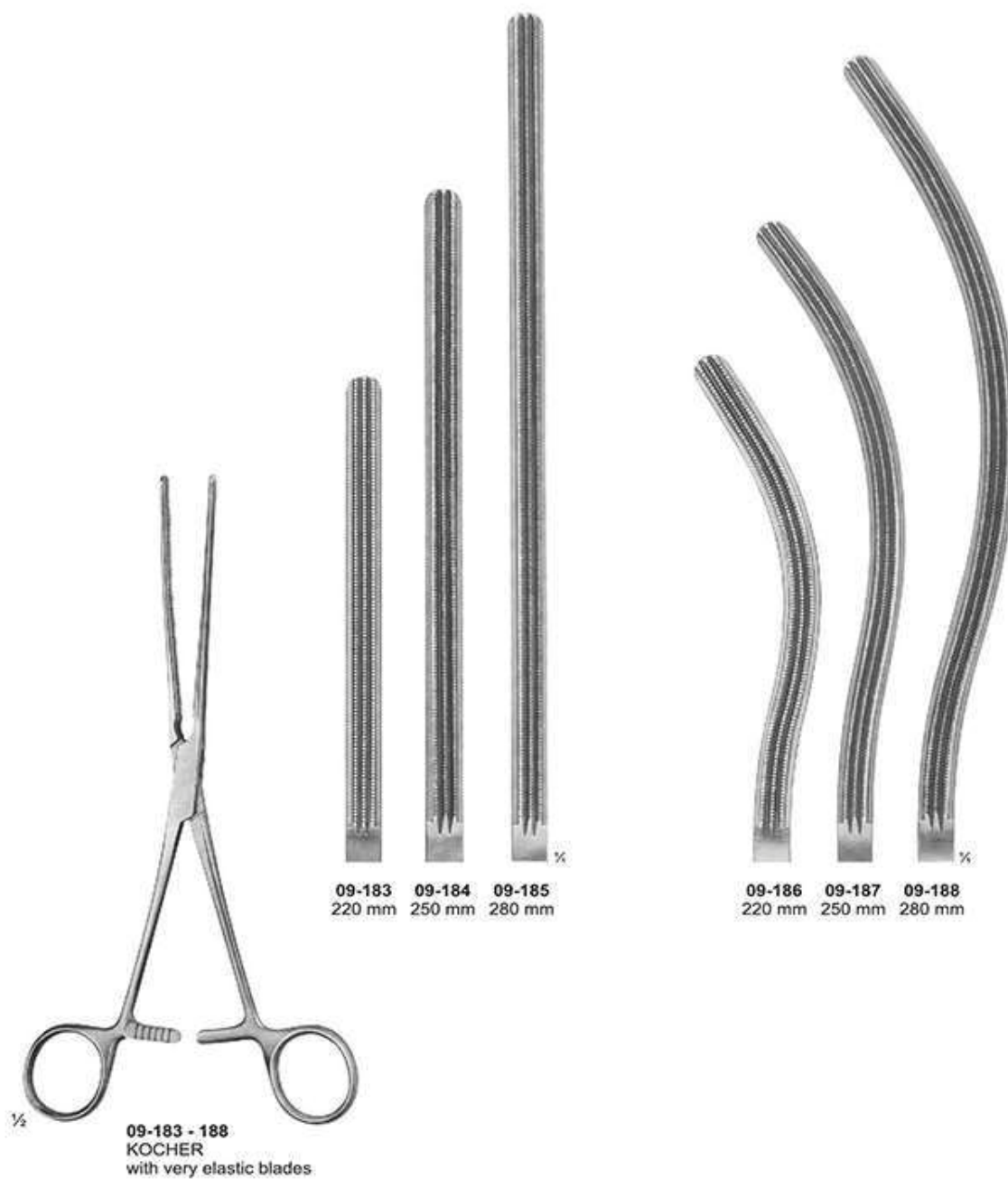

Intestinal Clamps, Soft elastic

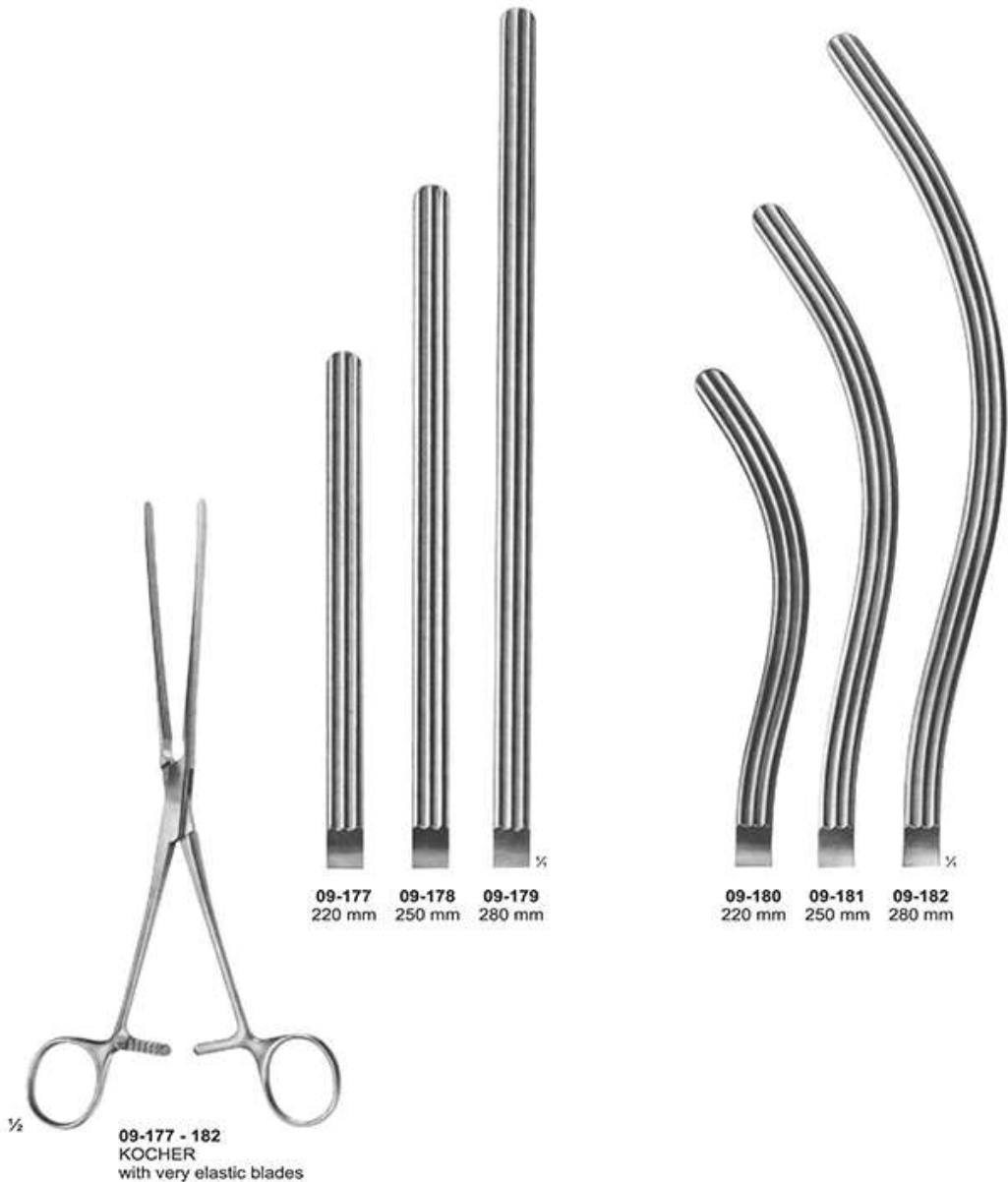

Intestinal Clamps, Soft elastic

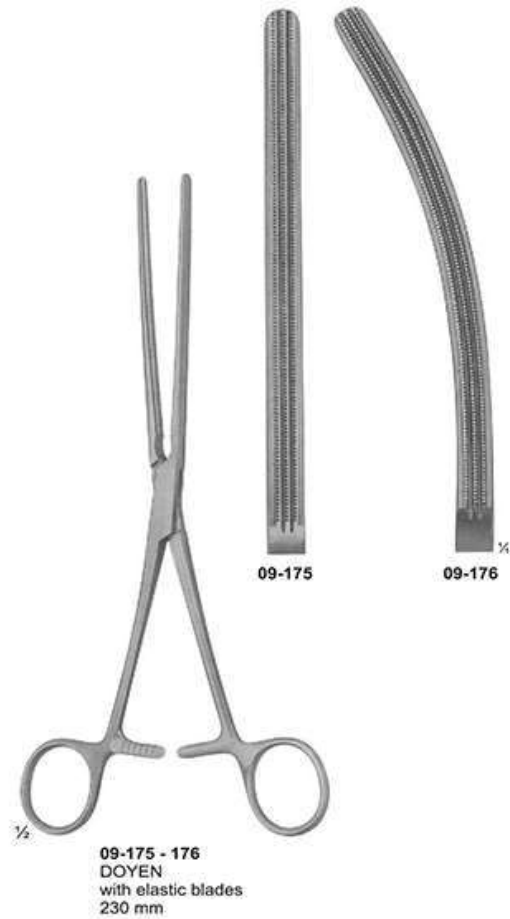
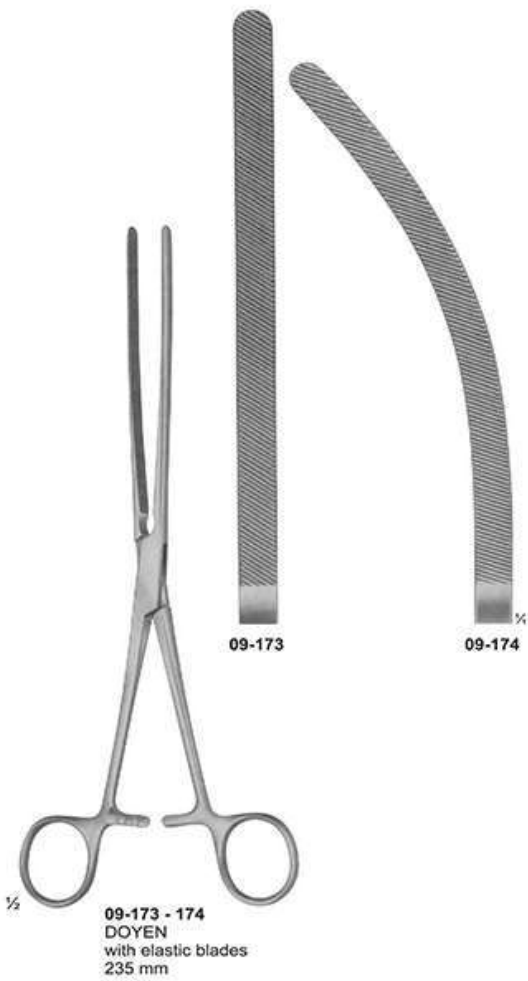

Intestinal Clamps, Soft elastic

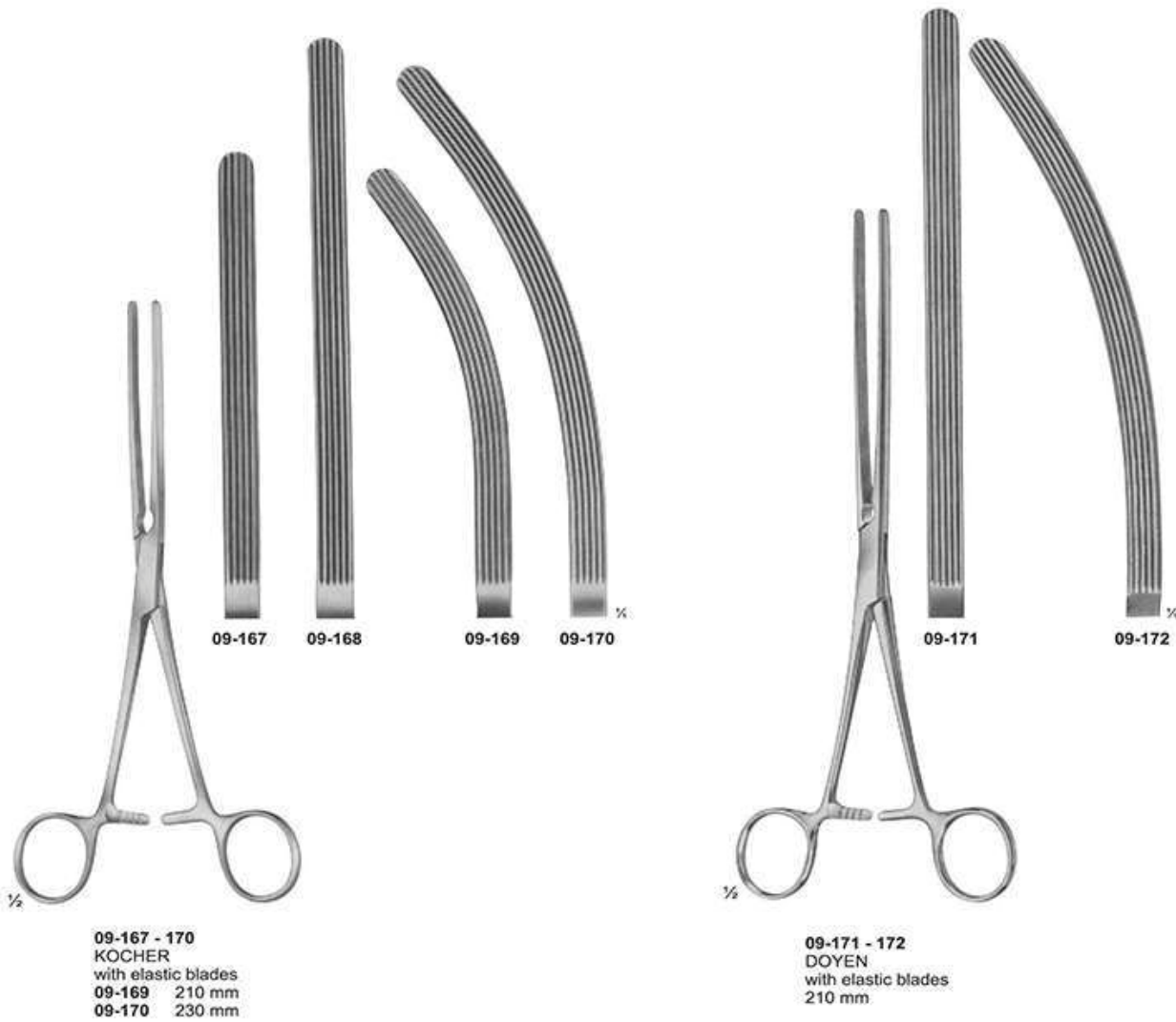

Intestinal Clamps, Soft elastic

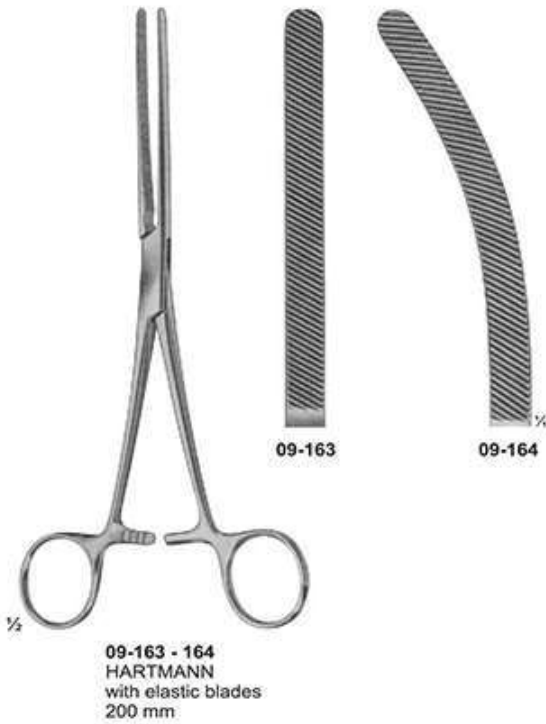
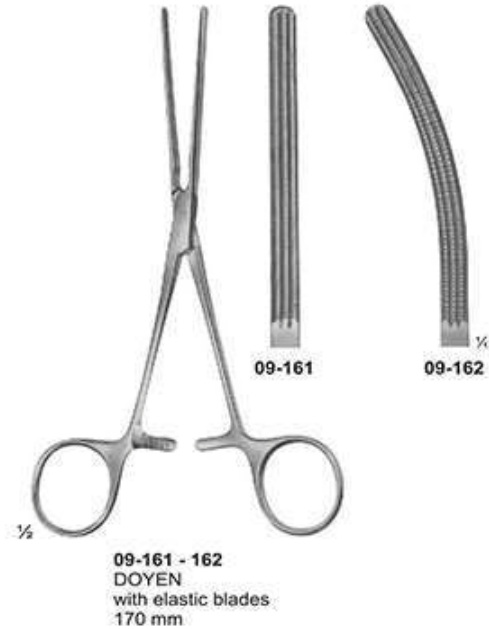

Intestinal Clamps for Children

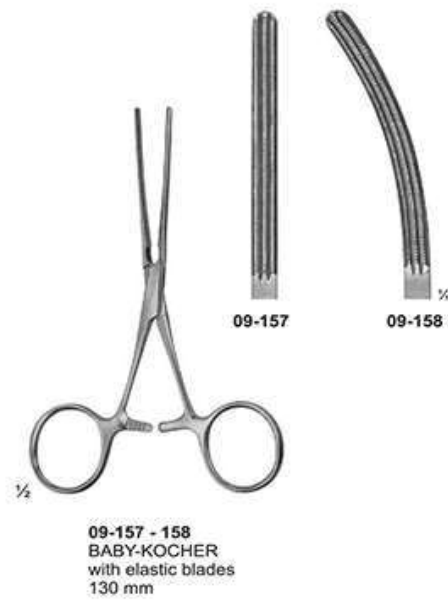

Ultra -Light - Forceps, Dissecting Forceps

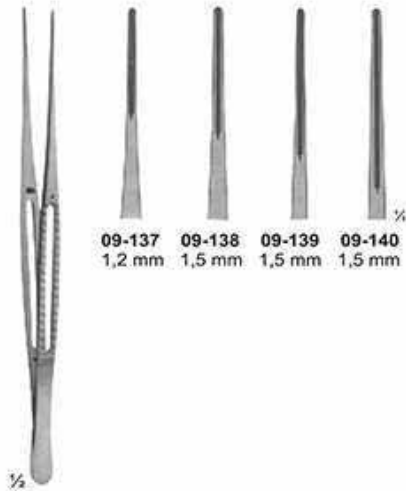

09-137 150 mm
09-138 200 mm
09-139 240 mm
09-140 300 mm

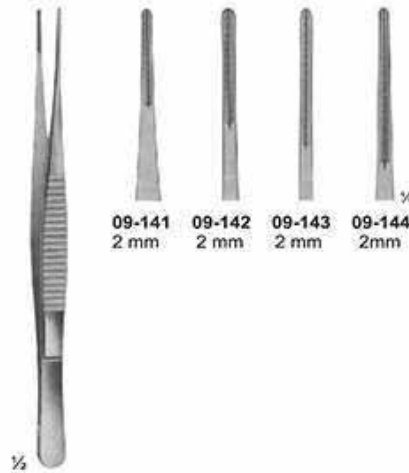

DE BAKEY
09-141 150 mm
09-142 200 mm
09-143 240 mm
09-144 300 mm

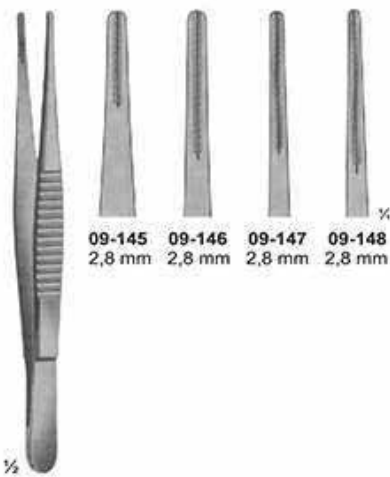

DE BAKEY
09-145 150 mm
09-146 200 mm
09-147 240 mm
09-148 300 mm

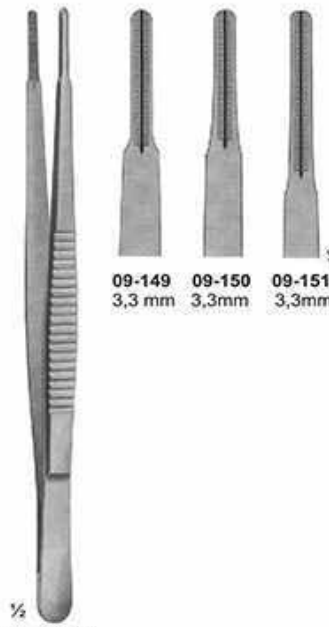

DE BAKEY
09-149 200 mm
09-150 240 mm
09-151 300 mm

Organ - Tissue Grasping, Dissecting & Intestinal Forceps

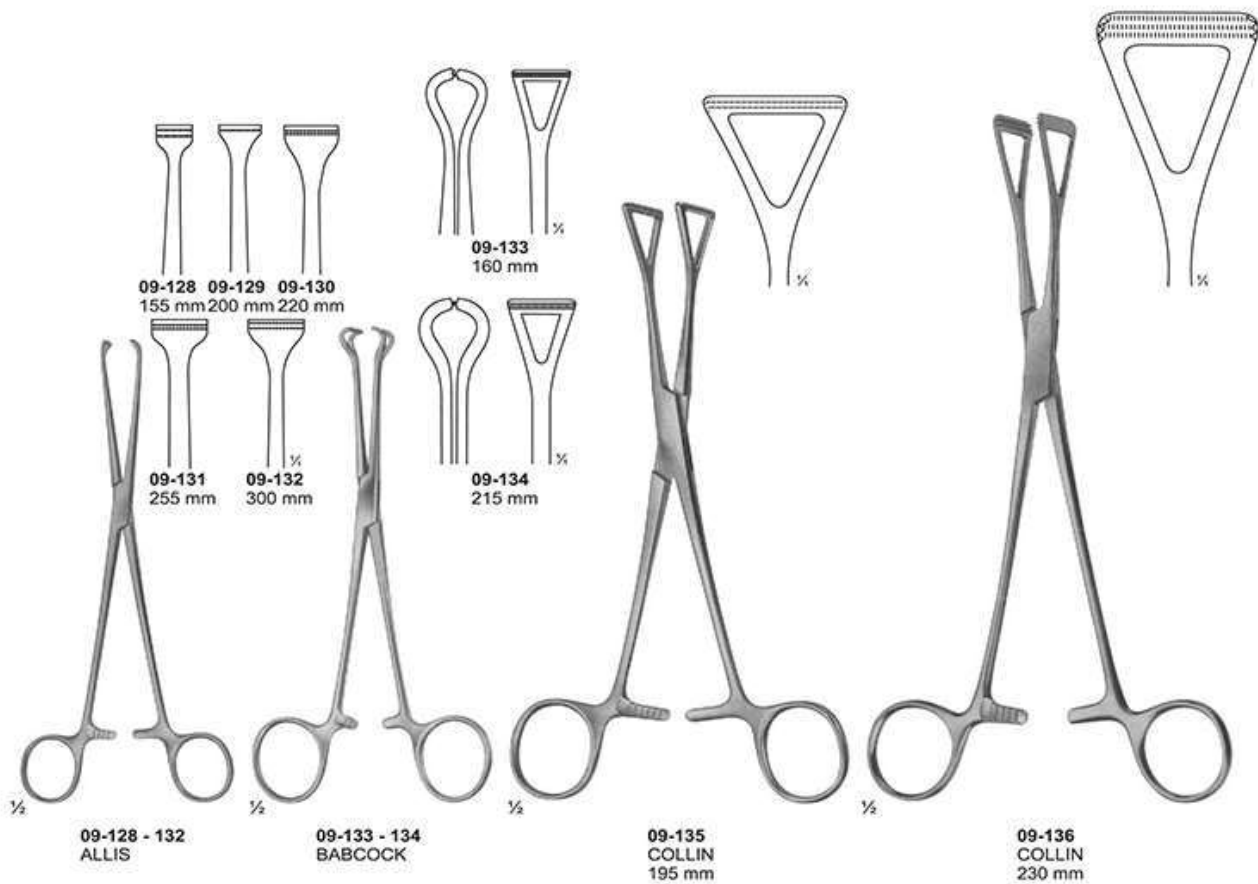

Organ - Tissue Grasping, Dissecting & Intestinal Forceps

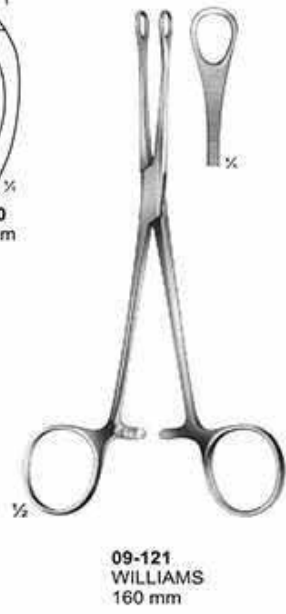
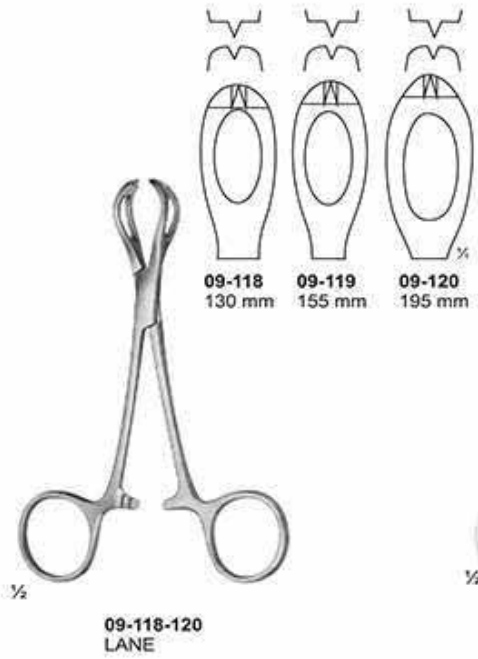

Intestinal Grasping Forceps

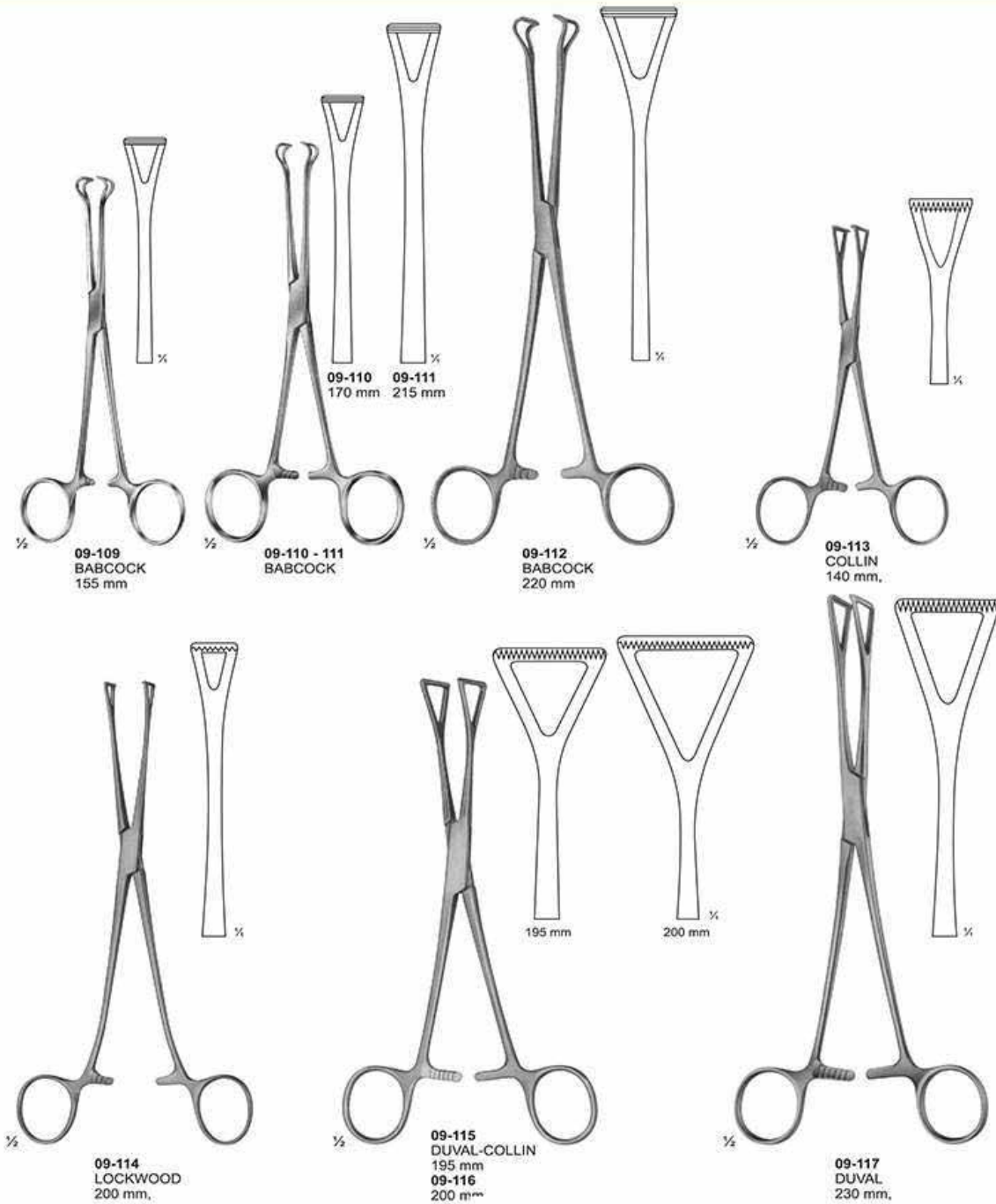

Intestinal and Tissue Grasping Forceps



09-101
CHAPUT
 2 X 3 teeth, sharp
 125 mm,



09-102
TUFFIER
 5 X 6 teeth, sharp
 125 mm,



09-103
BOYS-ALLIS
 5 X 6 teeth, sharp
 155 mm,

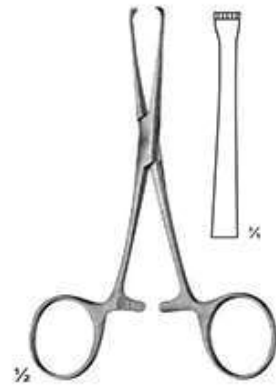

09-104
ALLIS
 4 X 5 teeth
 155 mm,

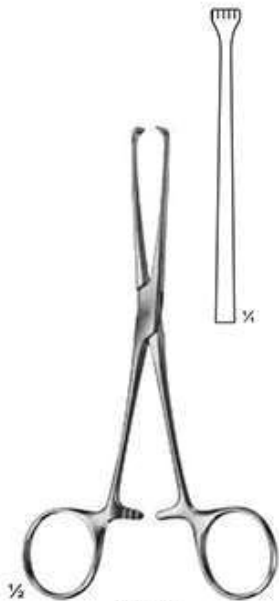

09-105
ALLIS
 155 mm,
 4 X 5 teeth

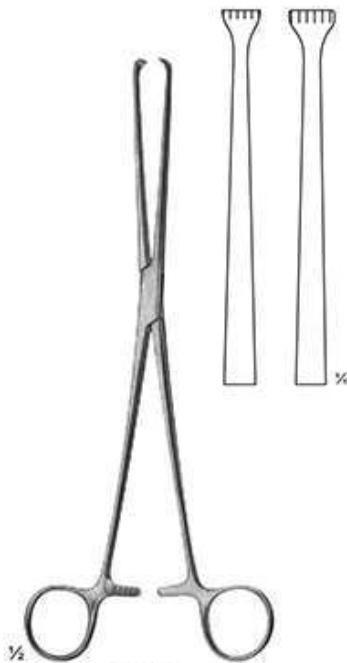

09-106
ALLIS
 190 mm,
09-107
 255 mm,
 5 X 6 teeth

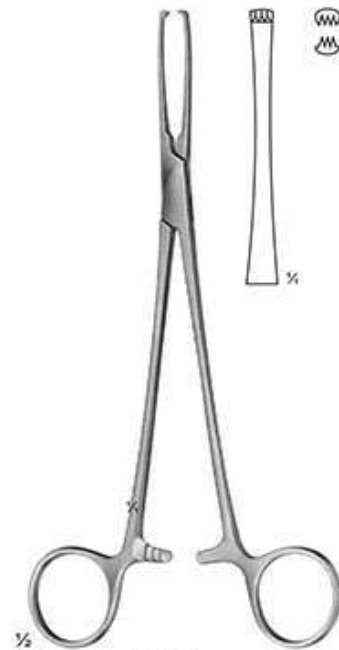

09-108
JUDD-ALLIS
 3 X 4 teeth
 195 mm,

Abdominal Retractors

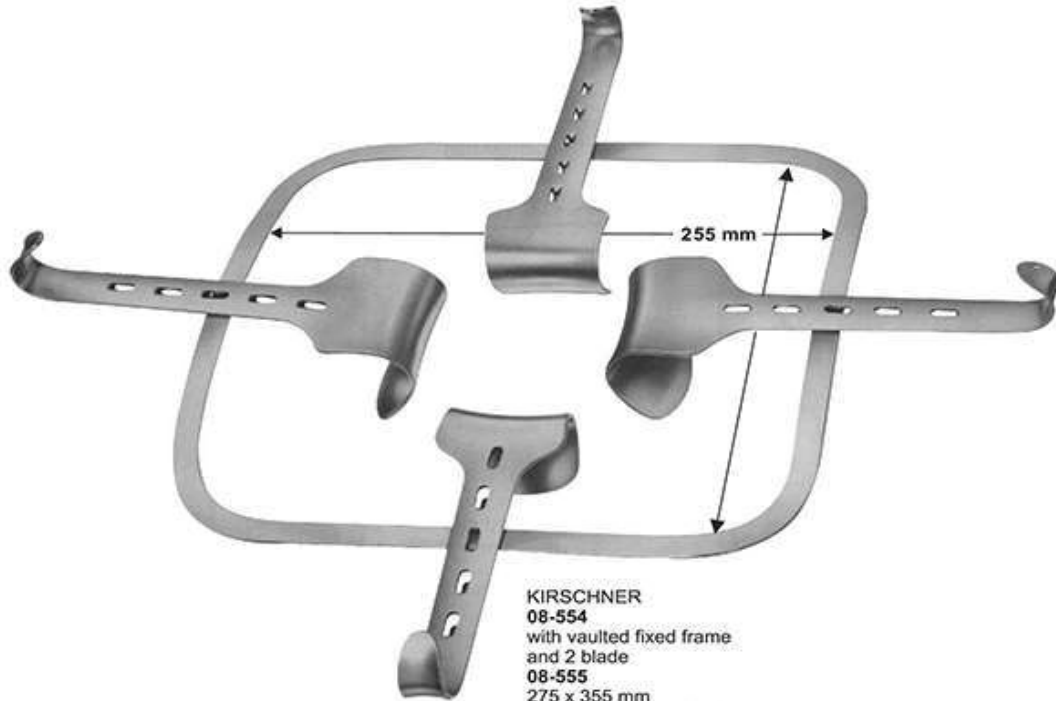

KIRSCHNER
08-554
with vaulted fixed frame
and 2 blade
08-555
275 x 355 mm
Frame only, over-sized
08-556
295 x 275 mm
Frame only



08-557
KIRSCHNER
64 x 80 mm



08-558
KIRSCHNER-BALFOUR
80x 82 mm



08-559 - 561
KIRSCHNER
08-559 90x 69mm
08-560 92x 95mm
08-561 78x 58mm



08-562 - 564
KIRSCHNER
08-562 108x42mm
08-563 91x 55mm
08-564 121x 55mm

Abdominal Retractors

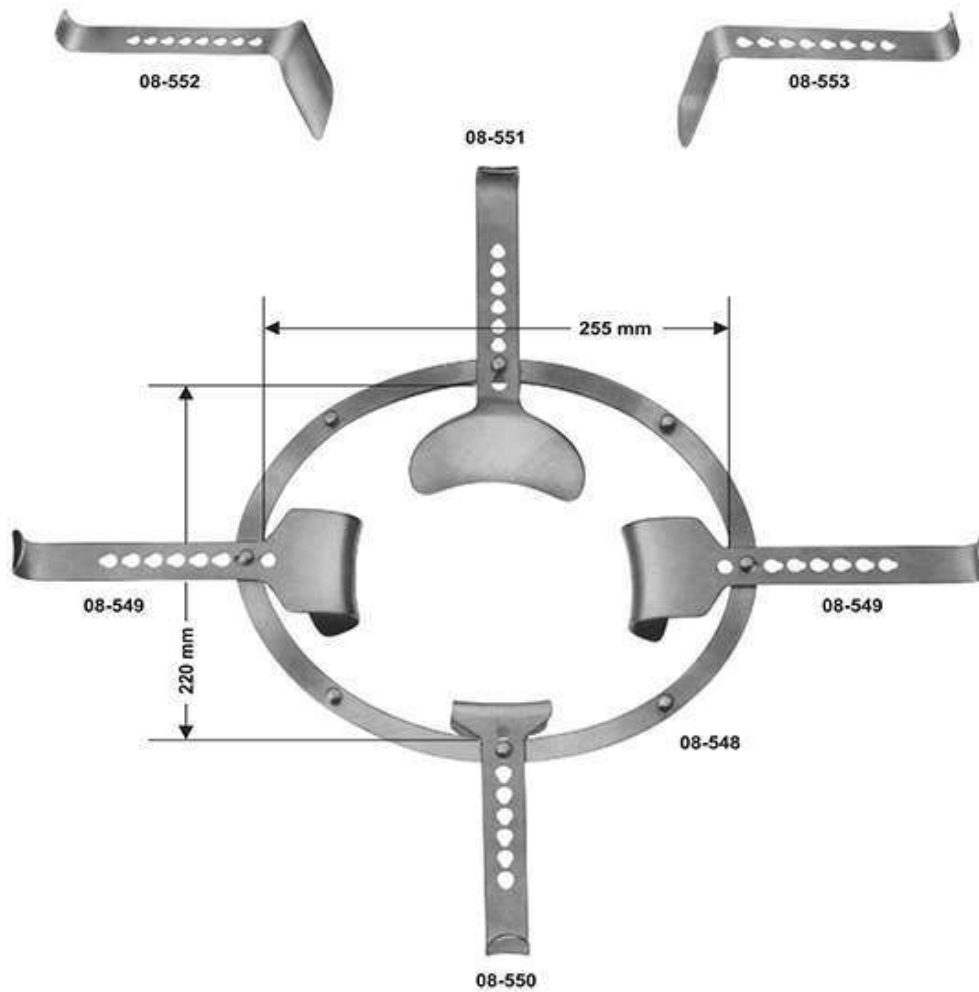

- 08-548 - 08-553**
SEMM
consisting of:
- 08-548** 1 frame 225 x 220 mm
 - 08-549** 2 blades 46 x 64 mm
 - 08-550** 1 blade 53 x 54 mm
(for bladder)
 - 08-551** 1 blade 82 x 97 mm
(for intestine)
 - 08-552** 1 blade 98 x 51 mm
(for intestine)
 - 08-553** 1 blade, narrow
107 x 36 mm

Abdominal Retractors

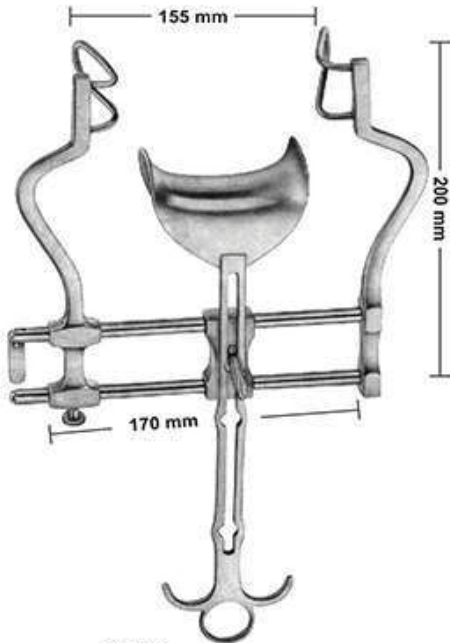

08-537
BALFOUR
 Lateral blades 60 mm deep
 Center blade 47 x 80 mm

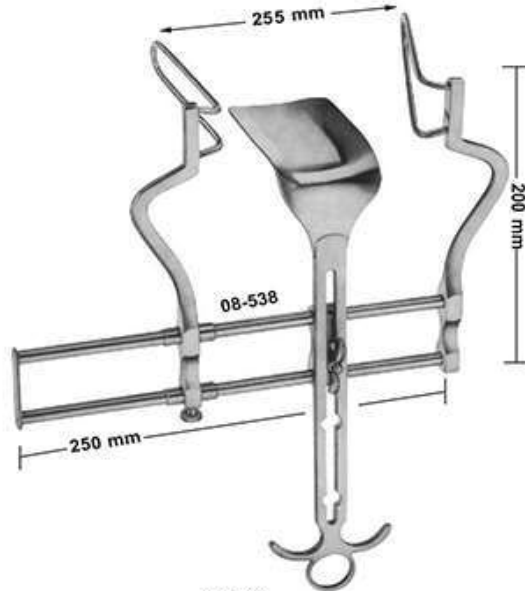

08-538
BALFOUR
 Lateral blades 105 mm deep
 Center blade 107x 59 mm



08-539
 Center blade only
 54x80 mm

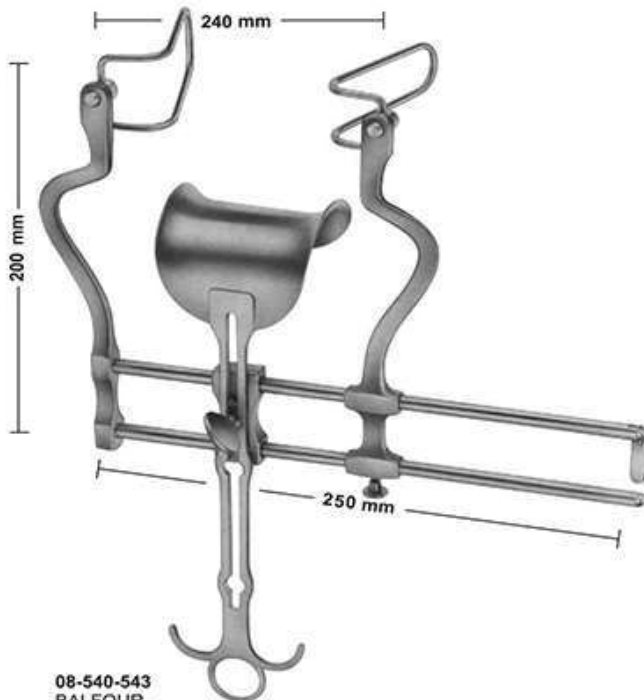

08-540-543
BALFOUR

Spreader only	08-540	08-541	08-542	08-543
Lateral blades	50 mm	60 mm	75 mm	90 mm
Center blade	47 x 80 mm	62x76 mm	80x80 mm	80x80 mm



Sales Unit of blades:PR = pair

Lateral blades
08-544
 50 mm deep
08-545
 60 mm deep
08-546
 75 mm deep
08-547
 90 mm deep

Abdominal Retractors



08-532
GOSSET
Blades: 38 mm deep

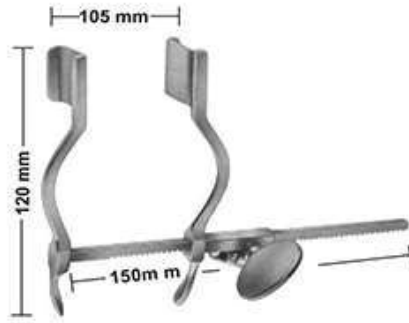

08-533
HERTZLER
Blades: 20 X 25 mm

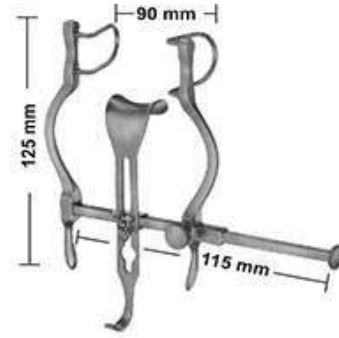

08-534
BALFOUR-BABY
Lateral blades 27 mm deep
Center blade 21x24 mm



08-535
GOSSET
Blades: 55 mm deep

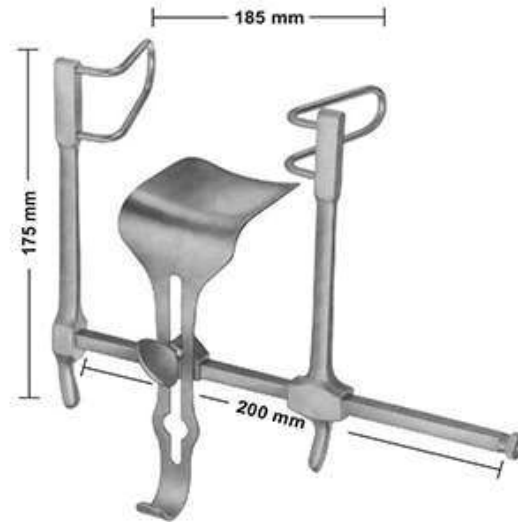

08-536
GOSSET
Lateral blades 58 mm deep
Center blade 59 x 57 mm

Abdominal Retractors

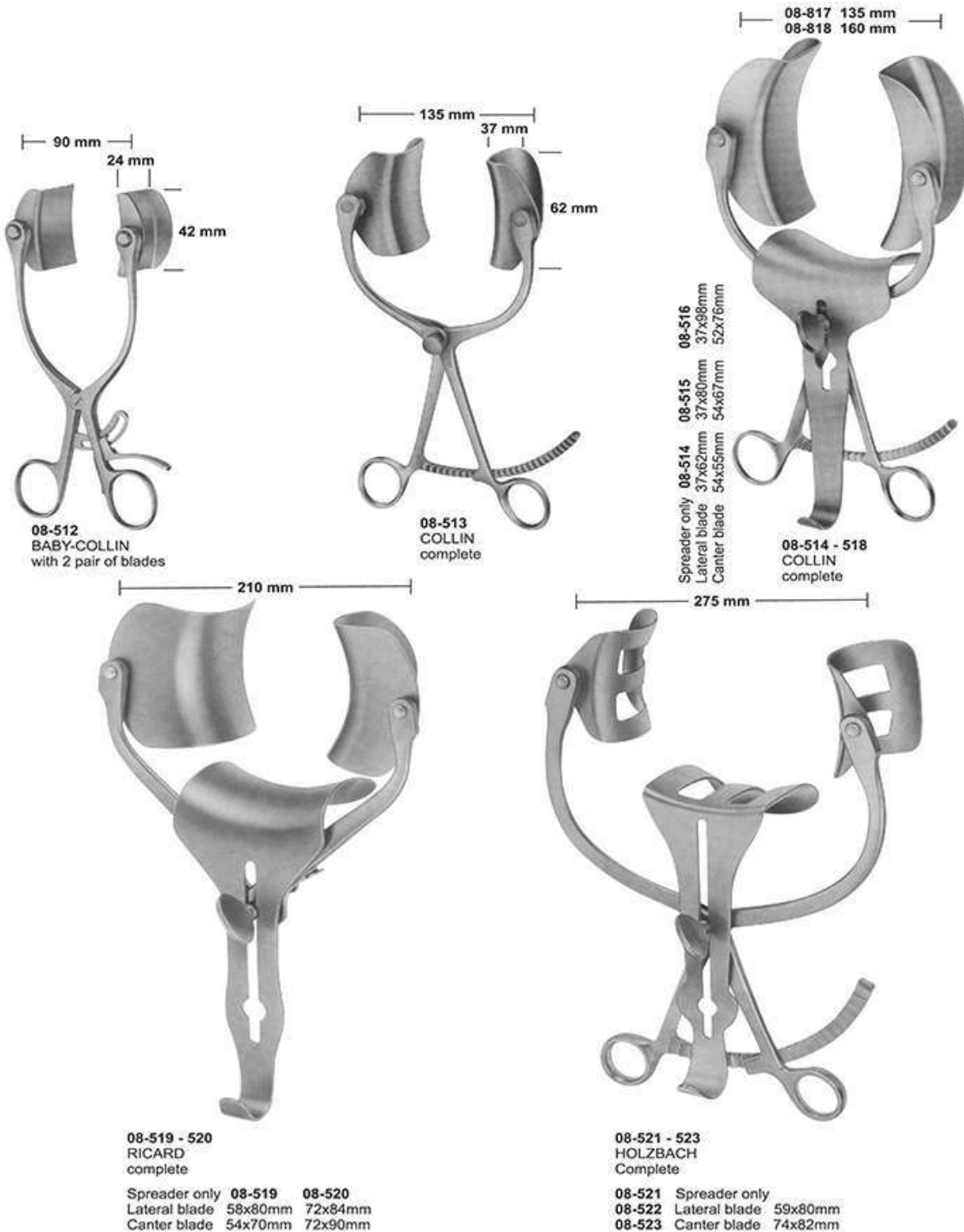

Abdominal Blades



Lateral blades only
08-524 37x62 mm
08-525 37x80 mm
08-526 37x98 mm

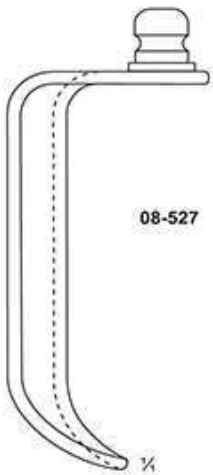

08-527 61x80 mm

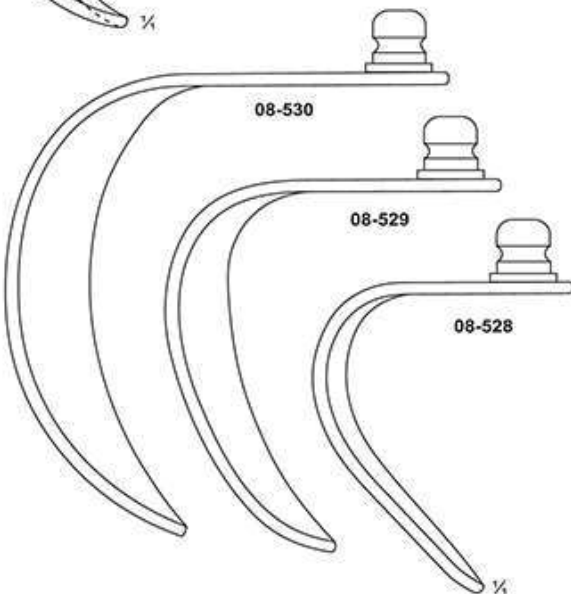

08-528 48x59 mm
08-529 58x80 mm
08-530 72x84 mm

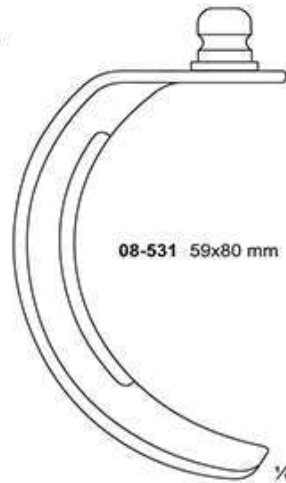

Lamina Spreaders

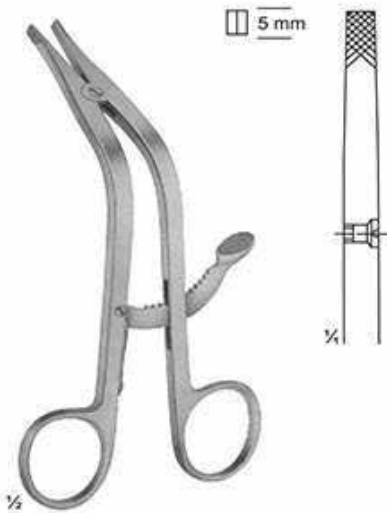

08-508
CLOWARD
155 mm



08-509
CLOWARD
135 mm

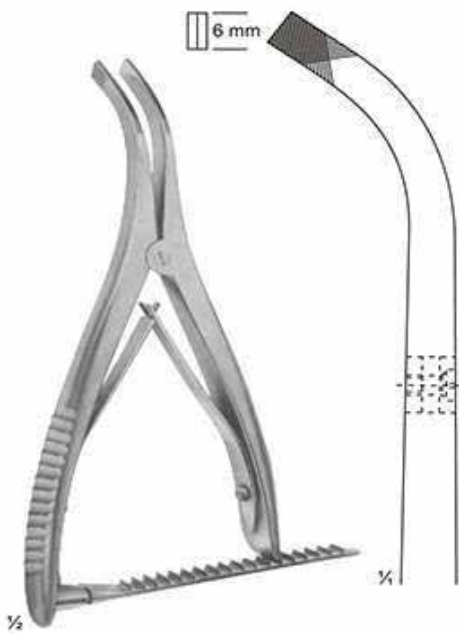

08-510
INGE
170 mm

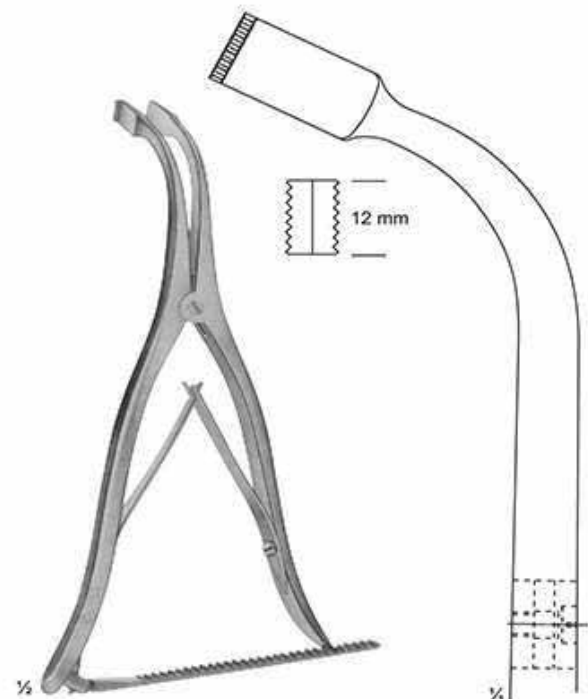

08-511
INGE
275 mm

Retractors for Cervical Vertebral Column

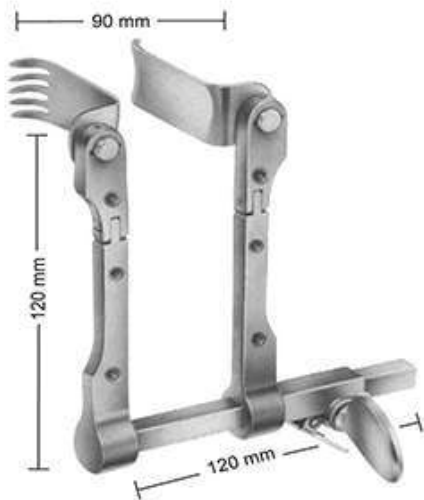

08-480
CASPAR
Retractor, adjustable,
consisting of: 5 medial
blades, 5 Lateral blades.



08-480 A
CASPAR
Counter retractor, adjustable,
consisting of: 5 blades.



08-481 40 x 23 mm
08-482 45 x 23 mm
08-483 50 x 23 mm
08-484 55 x 23 mm
08-485 60 x 23 mm
Medial blades



08-486 40 x 23 mm
08-487 45 x 23 mm
08-488 50 x 23 mm
08-489 55 x 23 mm
08-490 60 x 23 mm
Lateral blades



08-491 45 x 23 mm
08-492 50 x 23 mm
08-493 55 x 23 mm
08-494 60 x 23 mm
08-495 65 x 23 mm
Blunt blades



08-496 50 x 25 mm
08-497 60 x 25 mm
Blunt blades,
for harvesting of the
fusion graft from the
iliac crest



08-498 40 x 25 mm
08-499 45 x 25 mm
08-500 50 x 25 mm
08-501 55 x 25 mm
08-502 60 x 25 mm
Medial Titan blades
semi transparent to x-ray



08-503 40 x 25 mm
08-504 45 x 25 mm
08-505 50 x 25 mm
08-506 55 x 25 mm
08-507 60 x 25 mm
Lateral Titan blades
semi transparent to x-ray

Retractors for Cervical Spine



08-469
CLOWARD modif.
Spreader Only



16 mm
08-470



16 mm
08-471



16 mm
08-475



16 mm
08-476



16 mm
08-472

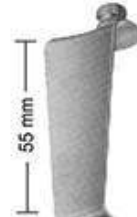

16 mm
08-473



16 mm
08-477



16 mm
08-478

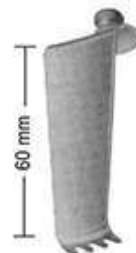

16 mm
08-474



16 mm
08-479

- 08-470 blade
- 08-471 blade
- 08-472 blade
- 08-473 blade
- 08-474 blade

- 08-475 blade
- 08-476 blade
- 08-477 blade
- 08-478 blade
- 08-479 blade

Self Retaining Retractors for Laminectomy and other Operations

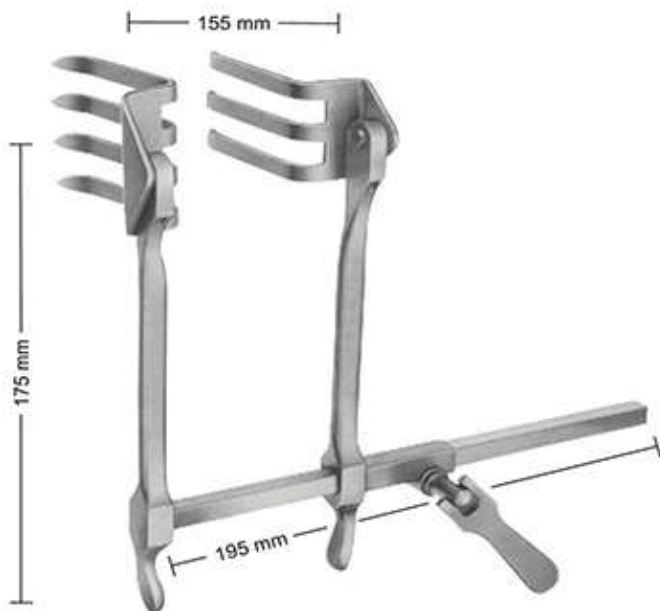

08-464 - 468
SCOVILLE-RICHTER
 Retractor with 1 pair
 blades reversible type.
 The Retractor bar and
 shanks may be easily
 rotated 180° when
 blades are in situ.



08-465
 62 x 52 mm
 PR= Pair
 62 x 37 mm



08-466
 47 x 51 mm



08-467
 30 x 40 mm



08-468
 37 x 62 mm

Special Retractors



1/2
08-459
JOLL (FRIEDMAN)
Thyroid- and Vaginal Retractor
155 mm



1/2
08-460
JACKSON BURROWS
Retractor, blunt
185 mm



1/2
08-461
GELPI
Vaginal Retractor
135 mm



1/2
08-462
GELPI
Skin- and Vaginal Retractor
175 mm



1/2
08-463
DE BAKEY
Femur Retractor
145 mm

Self-Retaining Laminectomy Retractors

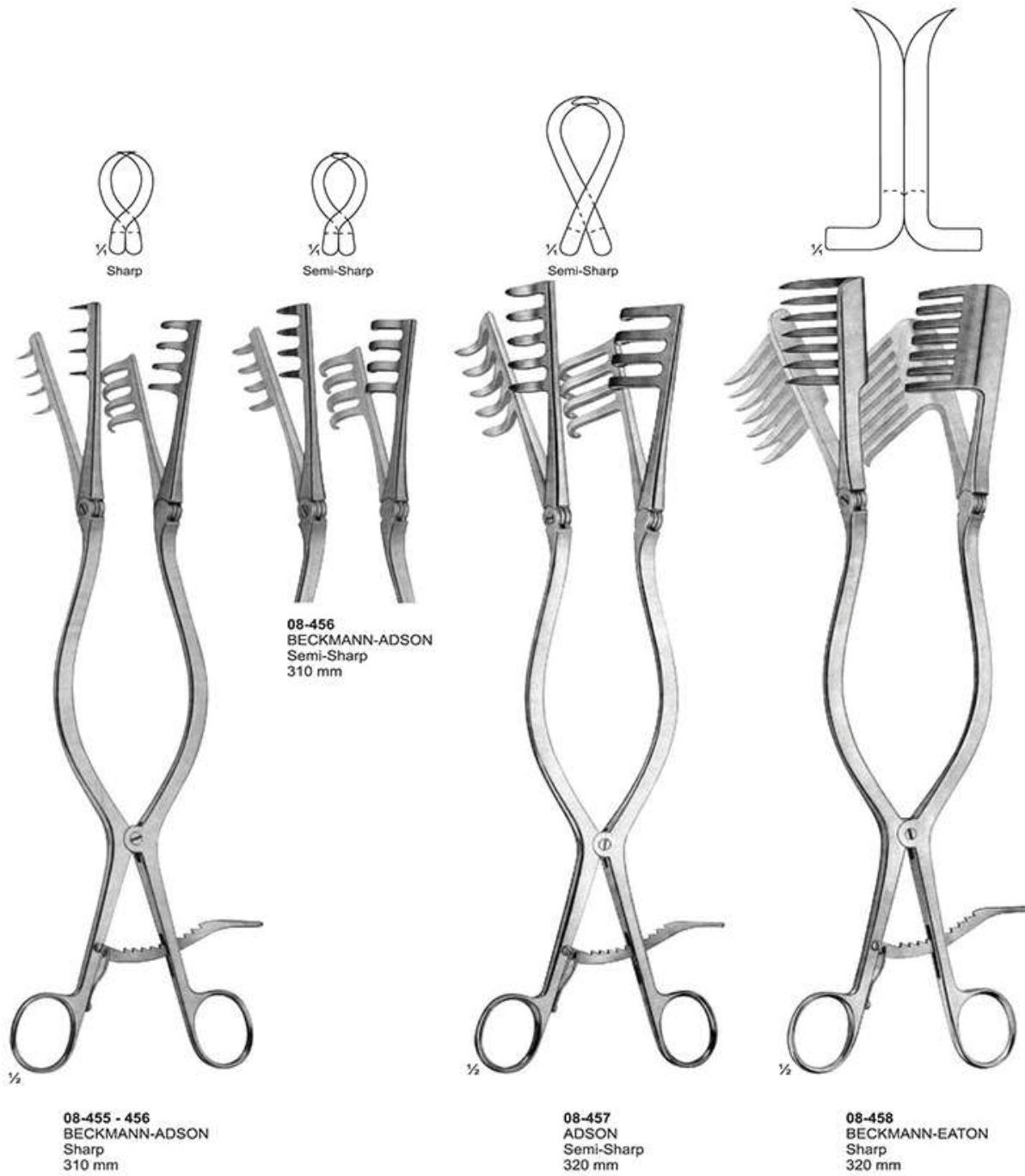

Self-Retaining Laminectomy Retractors

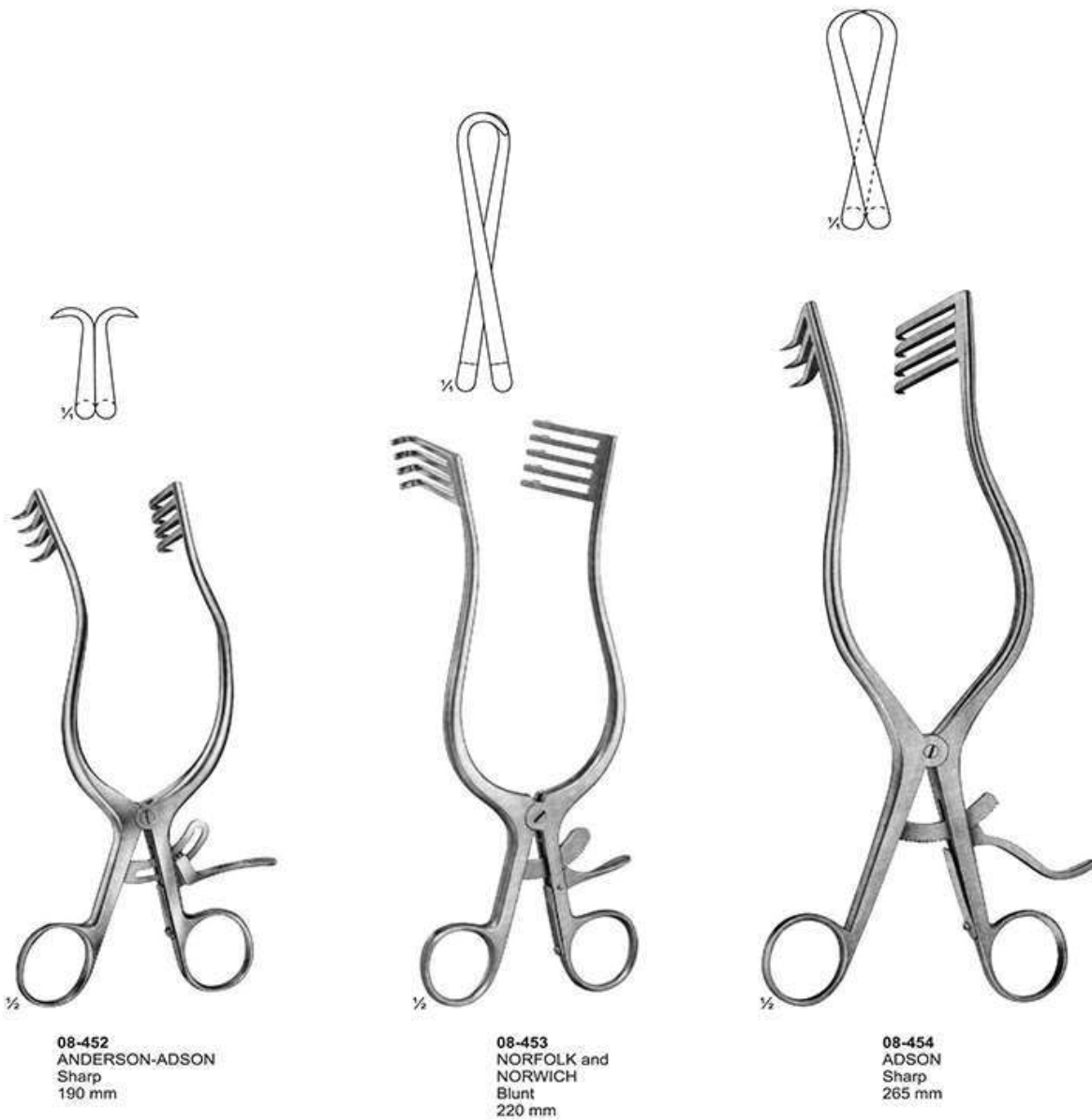

Self-Retaining Retractors



08-449
ADSON-BABY
Blunt
140 mm

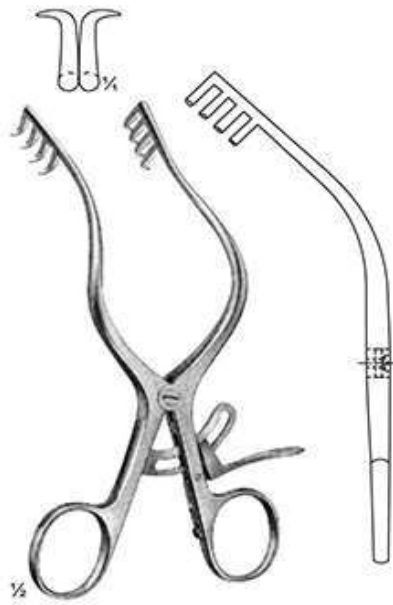

08-450
MOLLISON
Sharp
155 mm



08-451
MAYO-ADAMS
165 mm

Self-Retaining Retractors

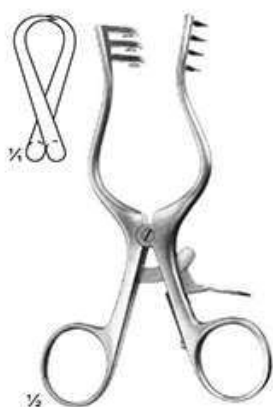

08-443
WEITLANER
Sharp
130 mm

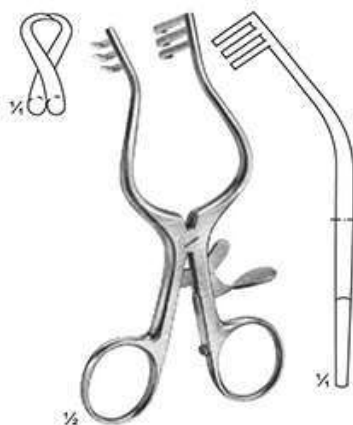

08-444
WULLSTEIN
Sharp
130 mm

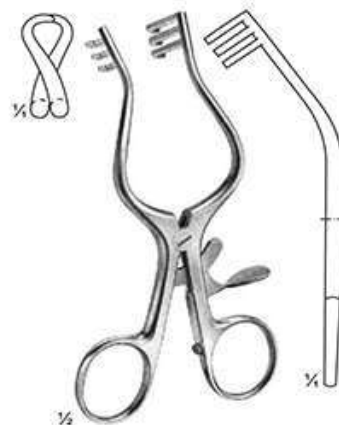

08-445
WULLSTEIN
Blunt
130 mm



08-446
WEITLANER
Sharp
165 mm



08-447
PLESTER
Blunt
110 mm

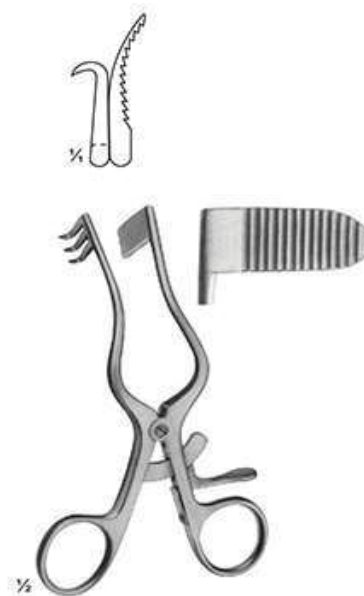

08-448
PERKINS
130 mm

Self-Retaining Retractors



08-437
WEITLANER
Sharp
110 mm



08-438
WEITLANER
Semi-Sharp
110 mm



08-439
WEITLANER
Blunt
110 mm



08-440
WEITLANER
Sharp
130 mm



08-441
WEITLANER
Semi-Sharp
130 mm



08-442
WEITLANER
Blunt
130 mm

Self-Retaining Retractors



08-423
BOSE
60 mm



08-424
FINSEN
50 mm



08-425
FINSEN
70 mm



08-426
FINSEN modif.
75 mm



08-427
MUELLER
45 mm



08-428
MUELLER
55 mm



08-429
MUELLER
65 mm



08-430
ALM
100 mm



08-431 - 432
ALM
08-431 70 mm
08-432 100 mm



08-433
LOGAN
modif. REILL
50 mm



08-434
JANSEN
100 mm



08-435
JANSEN
100 mm

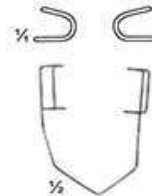

08-436
BARRAQUER
45 mm

Abdominal-and Intestinal Spatulas



08-417
REVERDIN
285 mm



08-418
HABERER
Malleable
305 mm



08-419 30 mm
08-420 40 mm
08-421 50 mm
Malleable
330 mm



08-422
TUFFIER
Malleable
200 mm

Abdominal-and Intestinal Spatulas

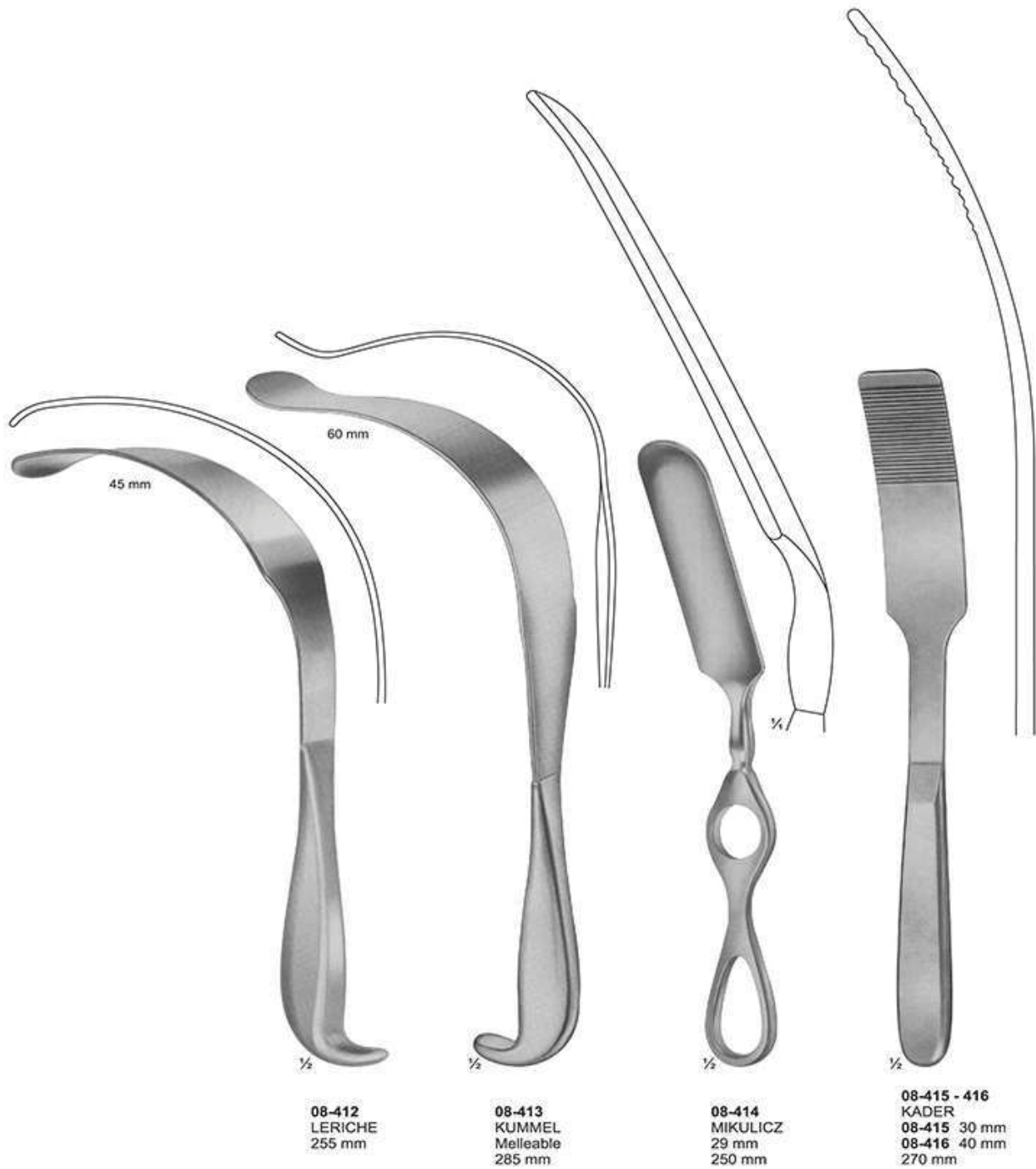

Pelvis Retractors

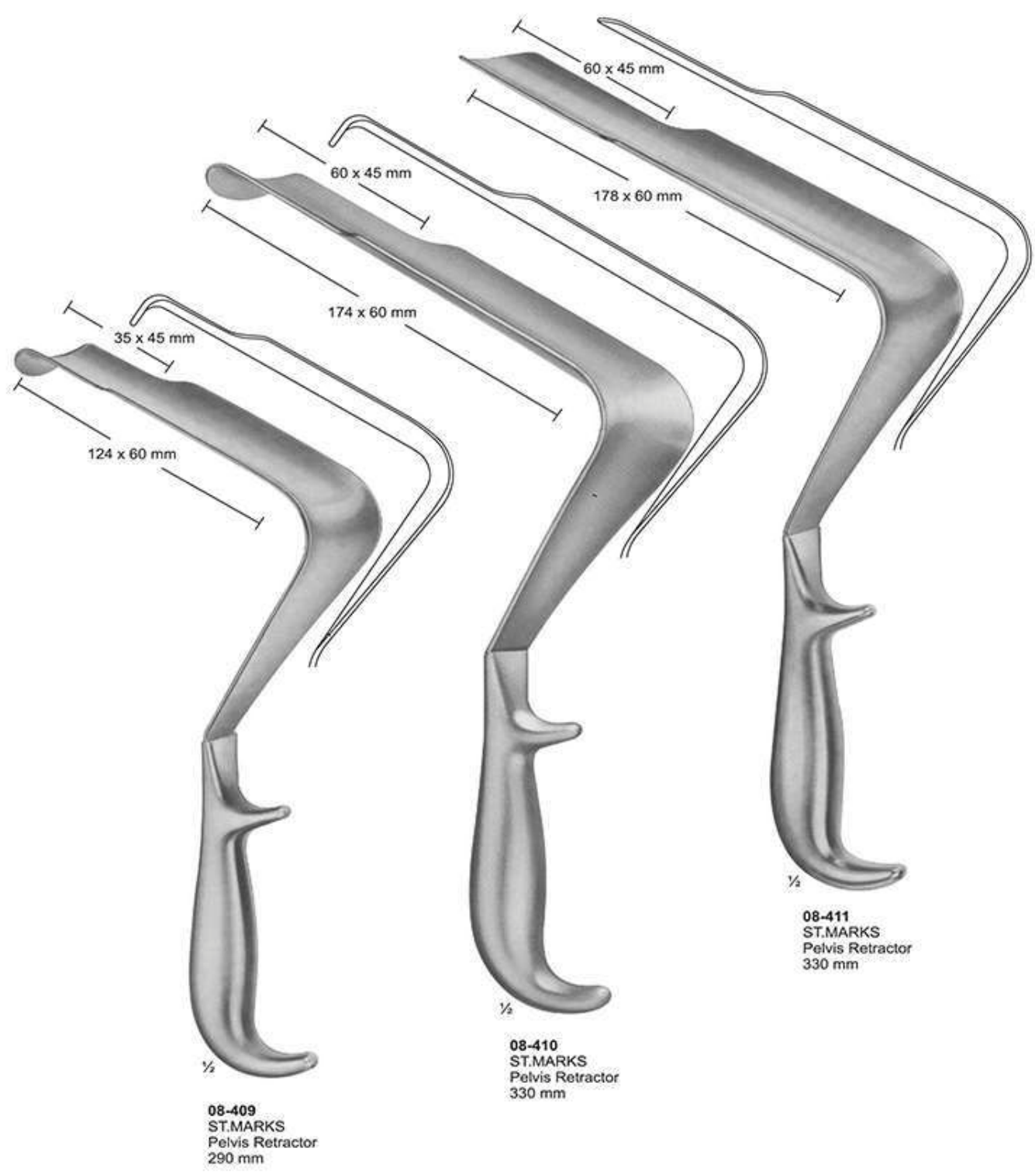

Abdominal Retractors



08-397 - 401
ROCHARD
310 mm
08-397 48 x 90 mm
08-398 48 x 105 mm
08-399 48 x 120 mm
08-400 48 x 135 mm
08-401 48 x 155 mm



08-402



08-403 - 406
DOYEN
280 mm
08-403 48 x 90 mm
08-404 48 x 105 mm
08-405 48 x 120 mm
08-406 48 x 135 mm



08-407
DOYEN-CHILD
Fixation device
220 mm



08-408
Chain with weight (747 / 645g)
790 mm

Retractors, Abdominal Retractors

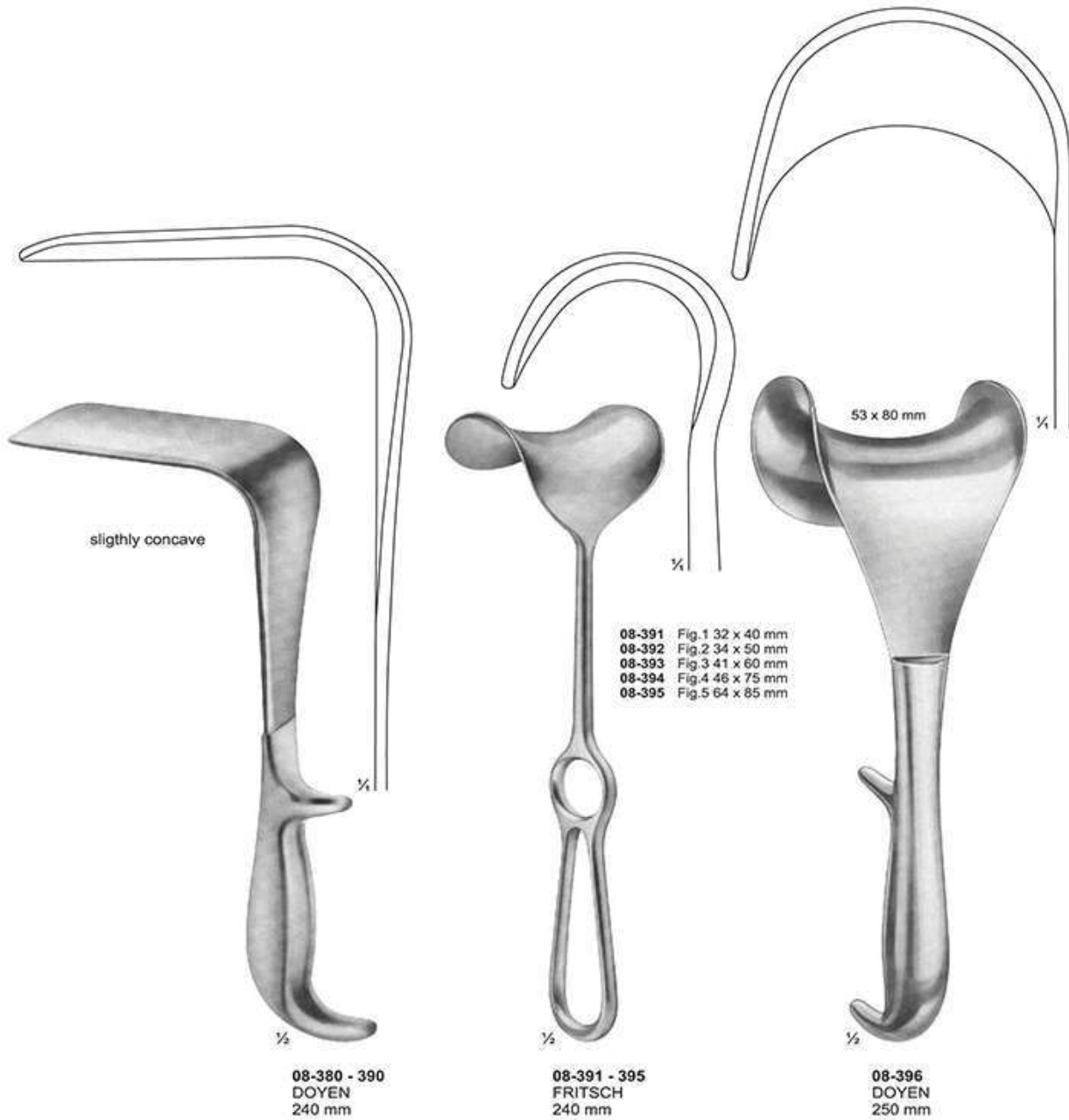

Width of Blades	
35 mm, 45 mm, 60 mm	
Length of Blades	08-380, 08-381, 08-382
62 mm	08-383, 08-384, 08-385
92 mm	08-386, 08-387, 08-388
122 mm	08-389, 08-390
160 mm	

08-380 - 390
DOYEN
240 mm

08-391 - 395
FRITSCH
240 mm

08-396
DOYEN
250 mm

Retractors For Deep Surgery (Abdominal Retractors)

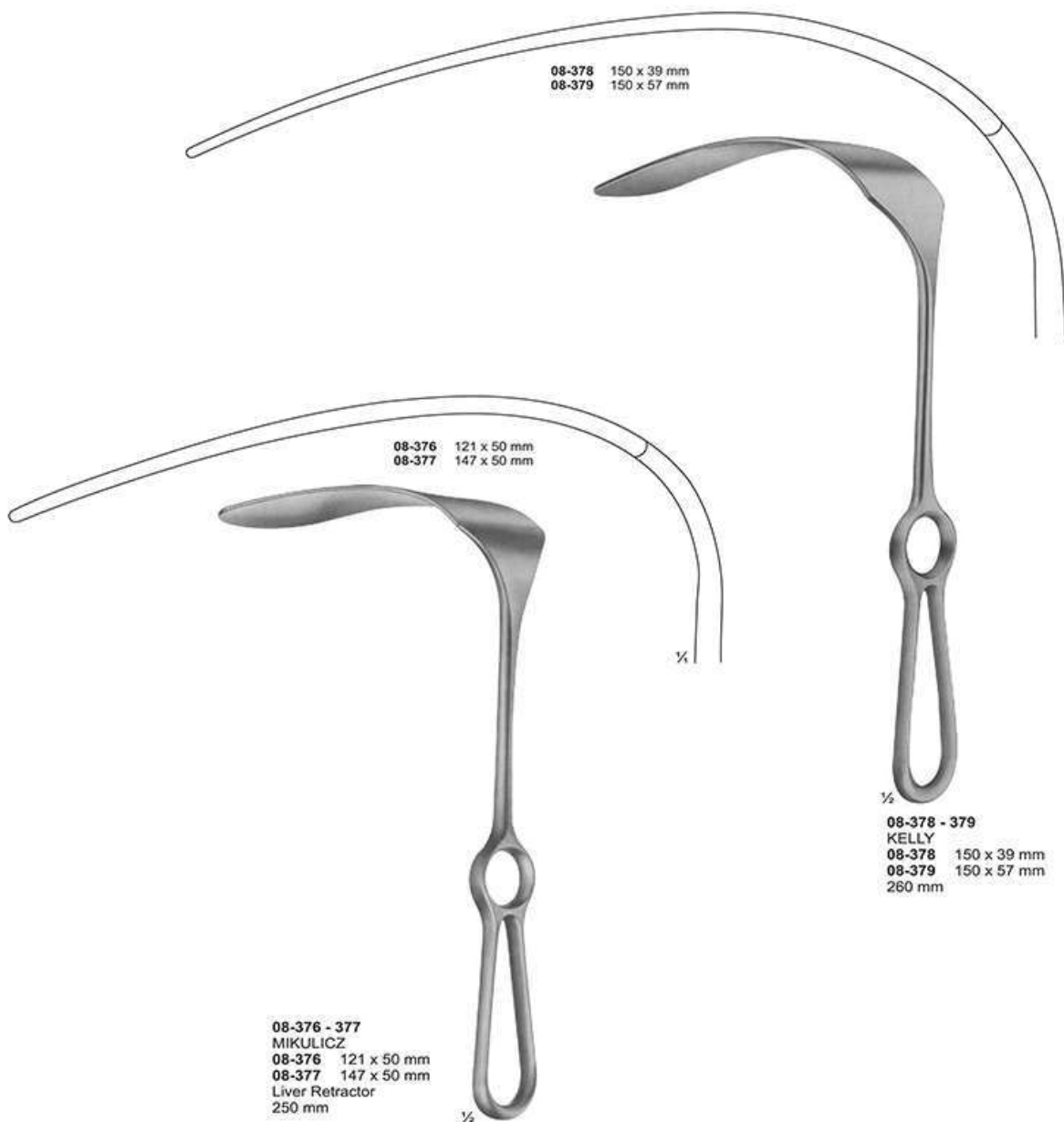

Retractors For Deep Surgery (Abdominal Retractors)

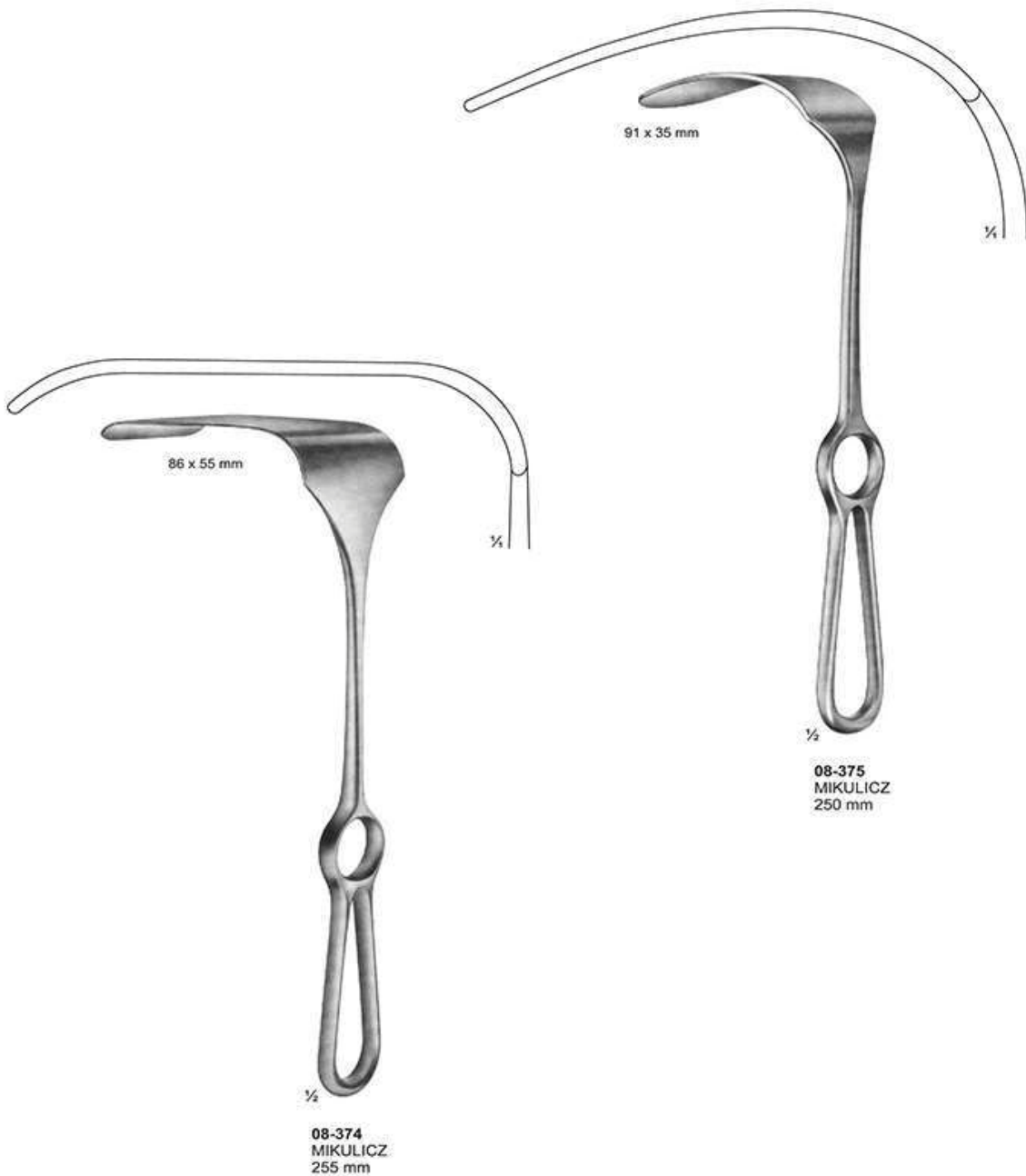

Retractors, Lung Spatulas



08-372
DEAVER
305 mm
Fig. 3



08-373
DEAVER
310 mm
Fig. 4

Retractors, Lung Spatulas

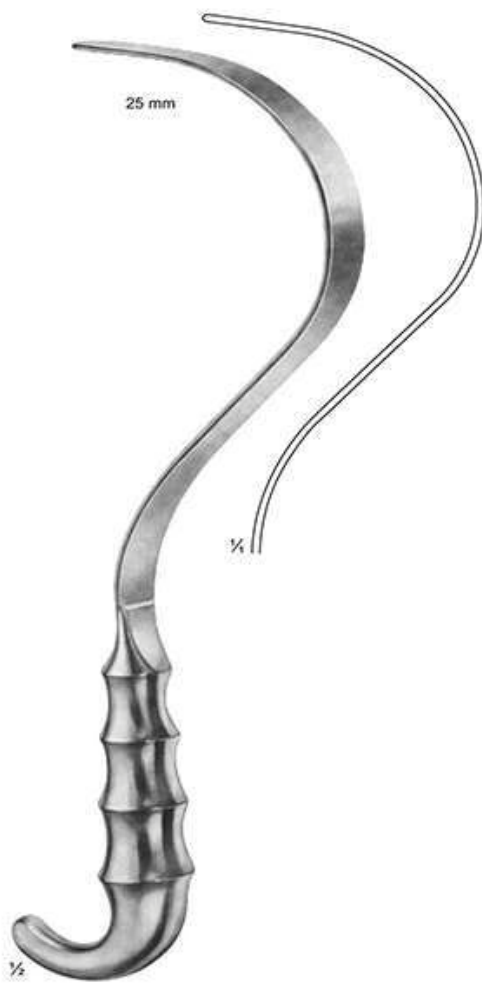

08-370
DEAVER
310 mm
Fig. 1



08-371
DEAVER
310 mm
Fig. 3

Retractors, Lung Spatulas



Retractors, Lung Spatulas

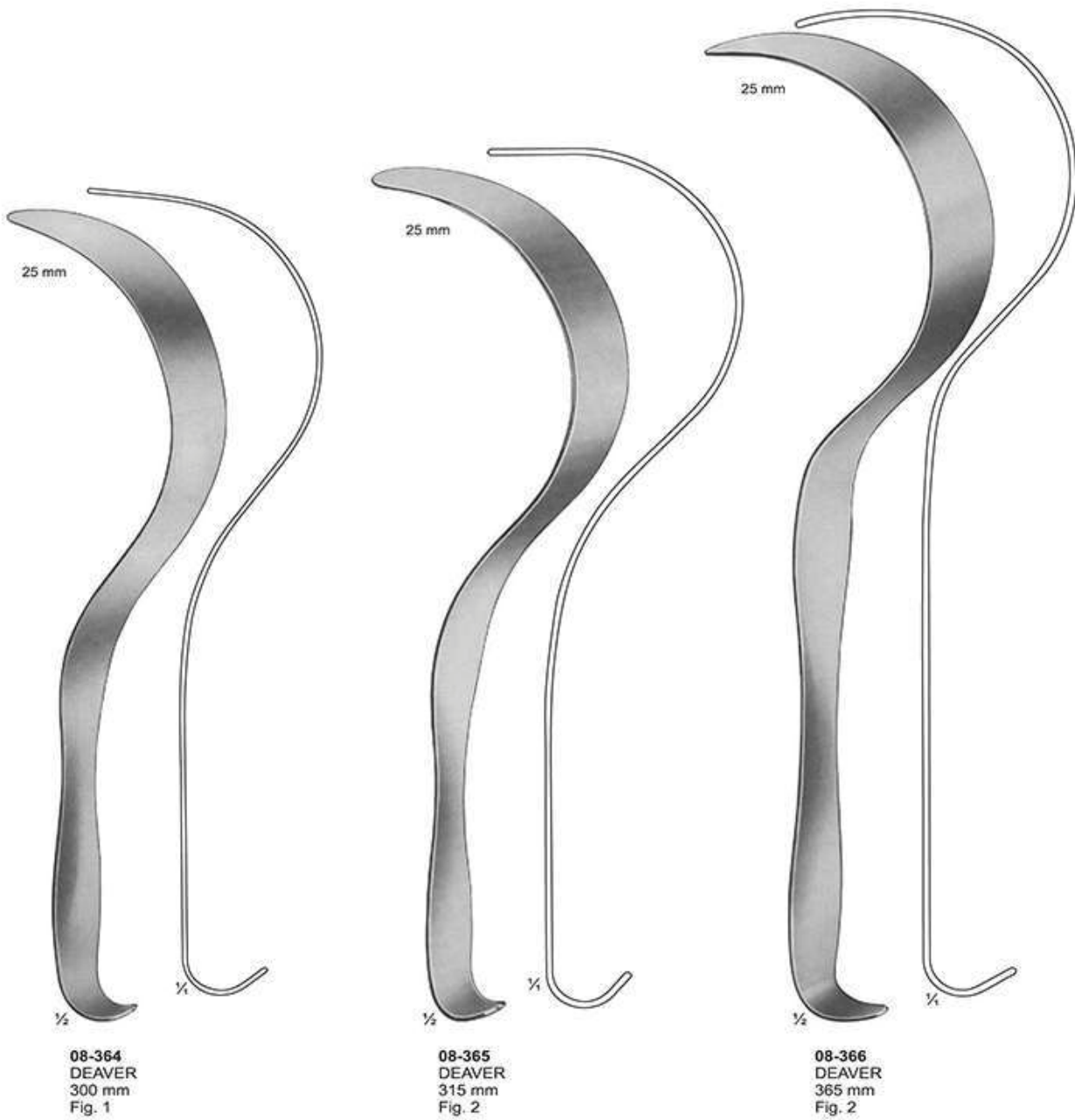

Retractors, Lung Spatulas

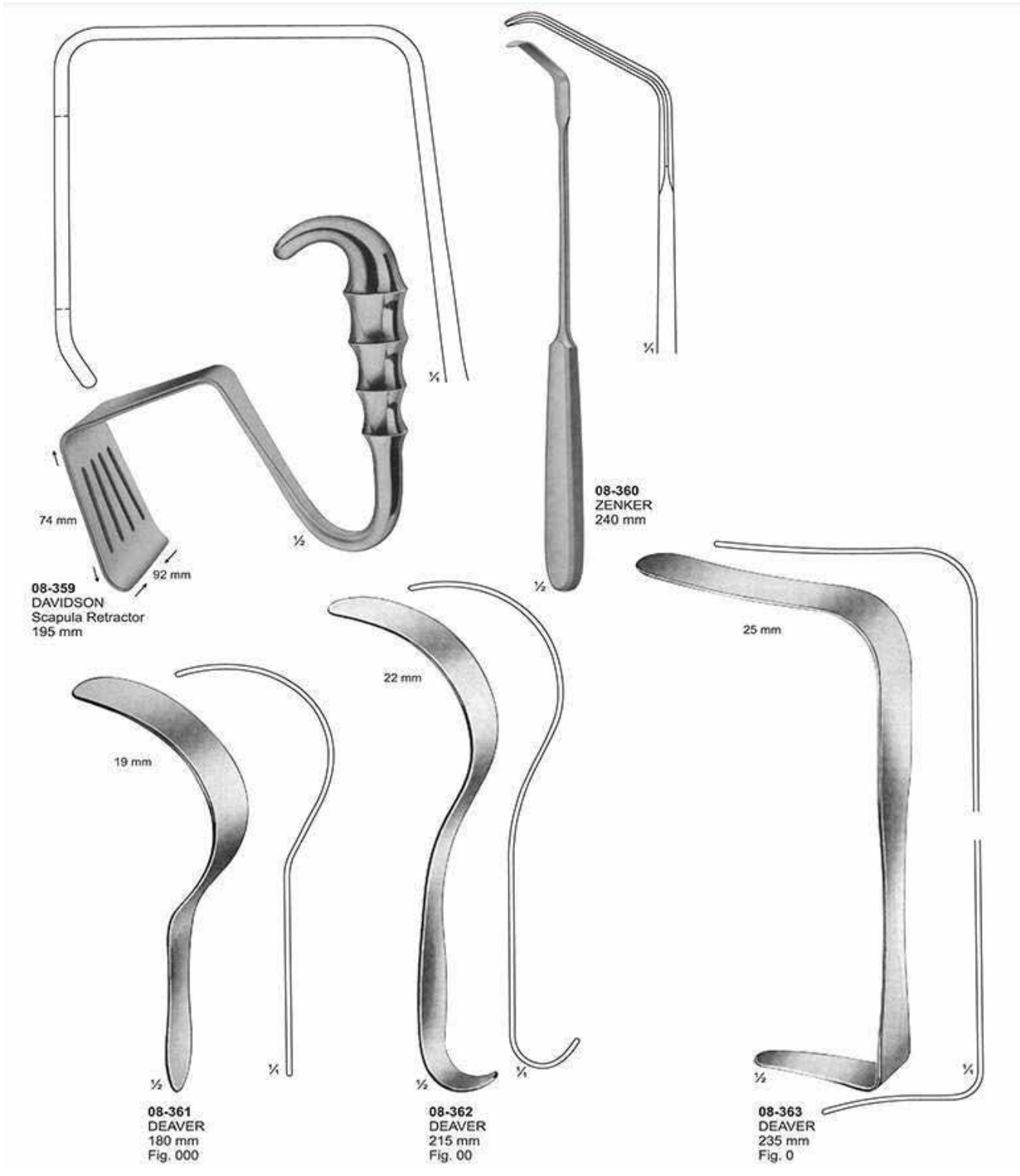

Retractors, Lung Spatulas

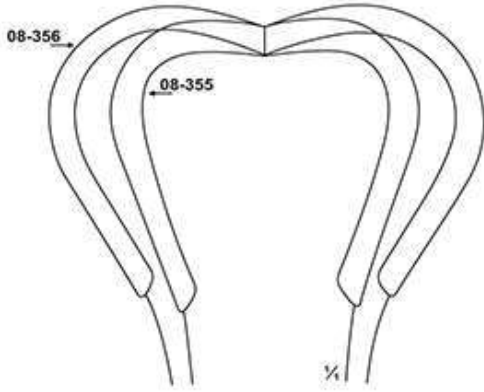

08-355 - 356
HARRINGTON
08-355 123 x 45 mm
08-356 123 x 64 mm
Flexible
295 mm



08-357
ALLISON
255 mm



08-358
ALLISON
320 mm

Vario Retractor System, Germ. Fed Patent,
Germ. Fed. Regd.Des.

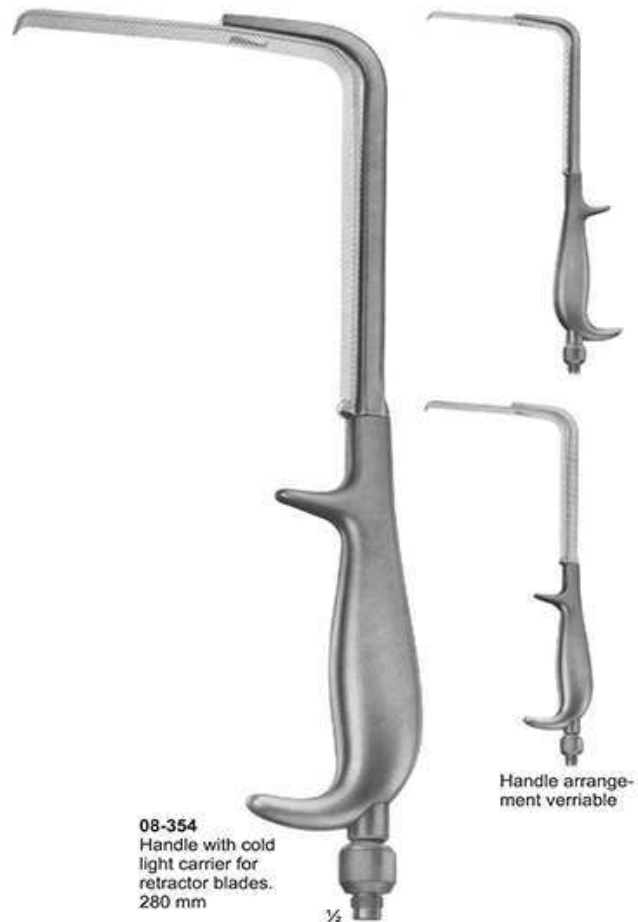
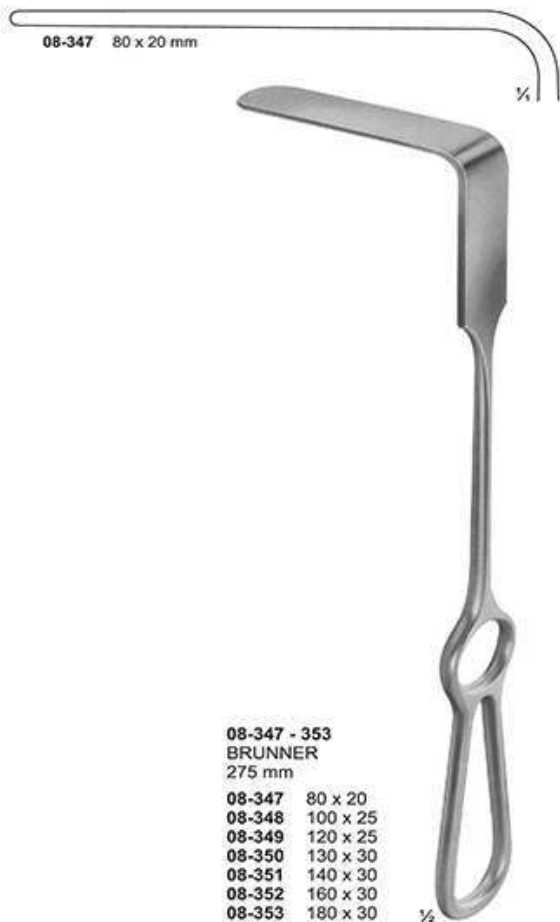

Retractors For Deep Surgery

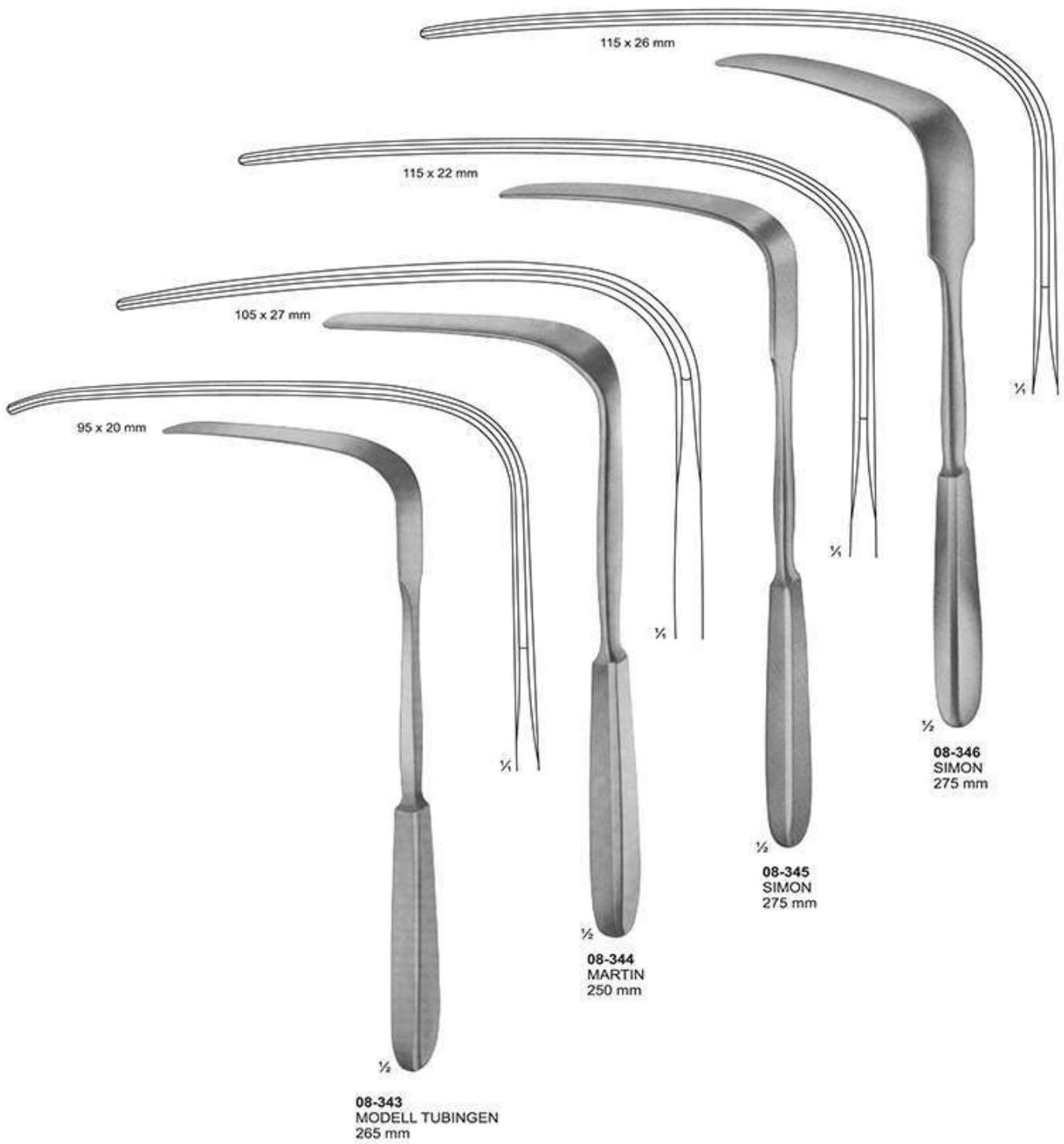

Retractors For Deep Surgery



Retractors

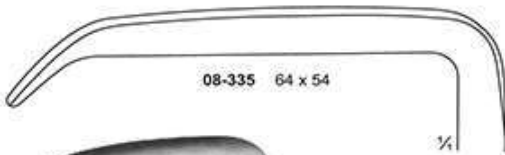
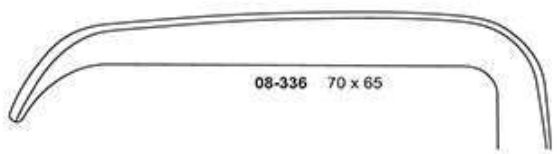

08-335 - 336
KELLY
260 mm

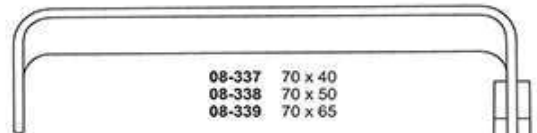

08-337 - 339
MORRIS
245 mm

Retractors

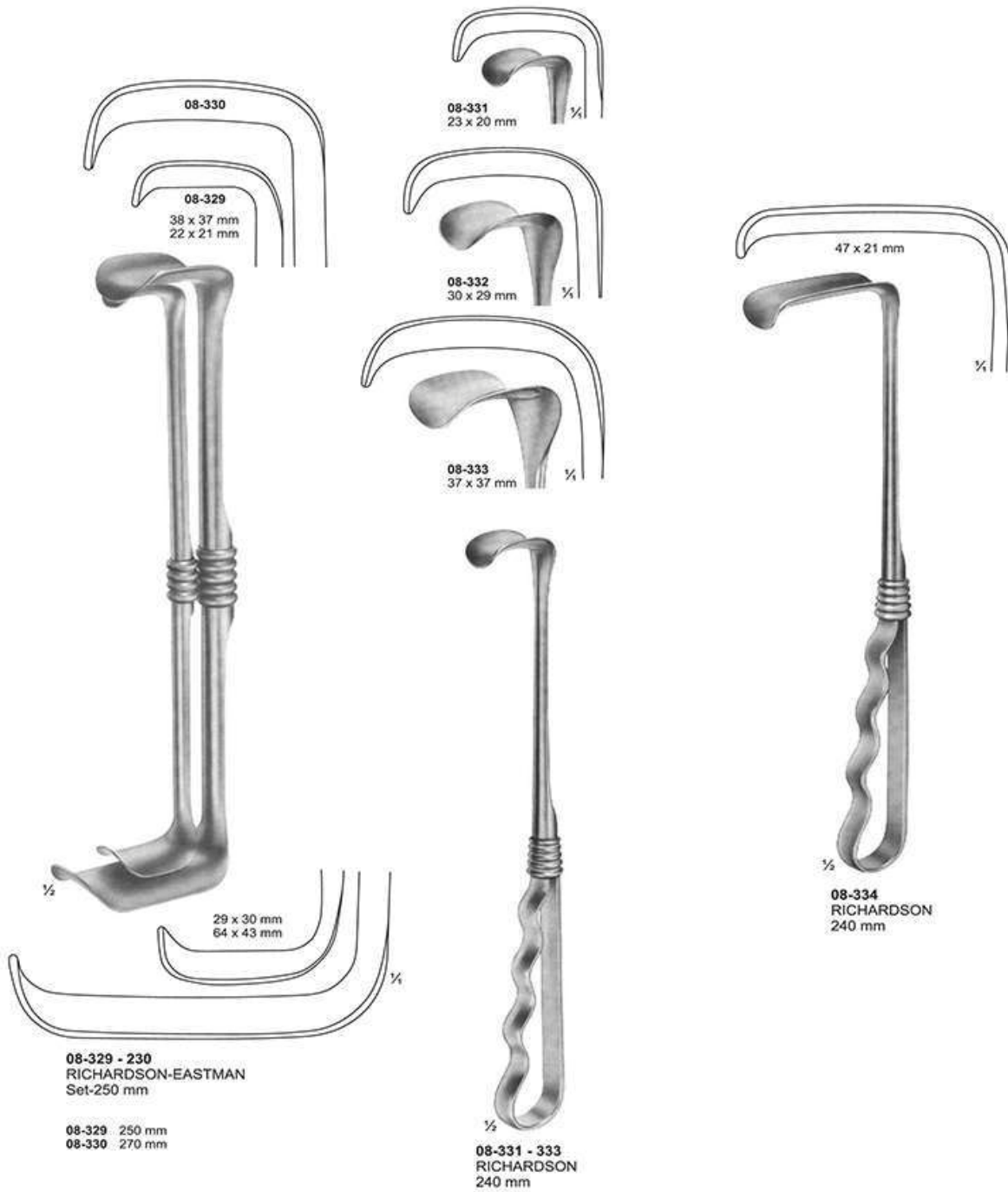

Retractors



08-323 - 328
HOSEL
250 mm

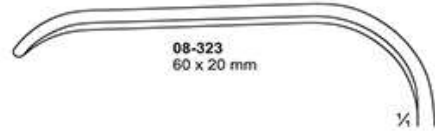

08-323
60 x 20 mm

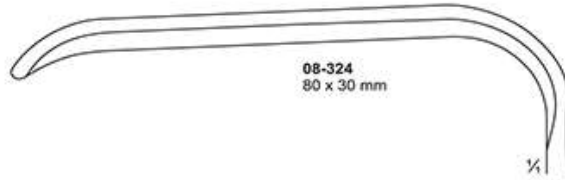

08-324
80 x 30 mm

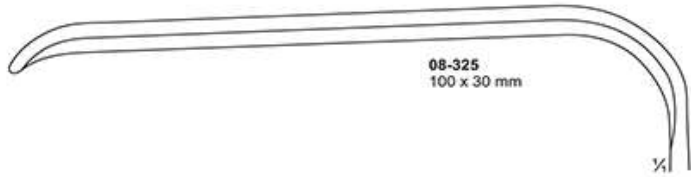

08-325
100 x 30 mm

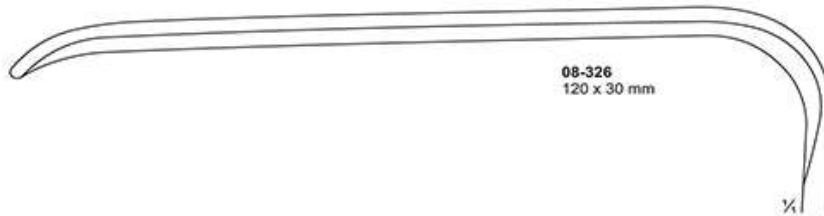

08-326
120 x 30 mm

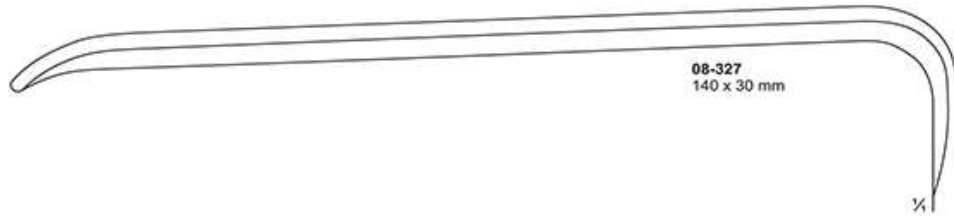

08-327
140 x 30 mm

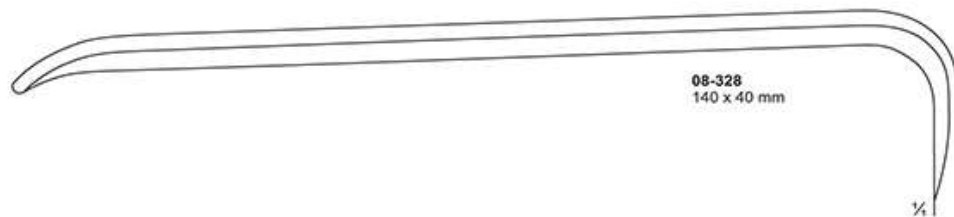

08-328
140 x 40 mm

Retractors

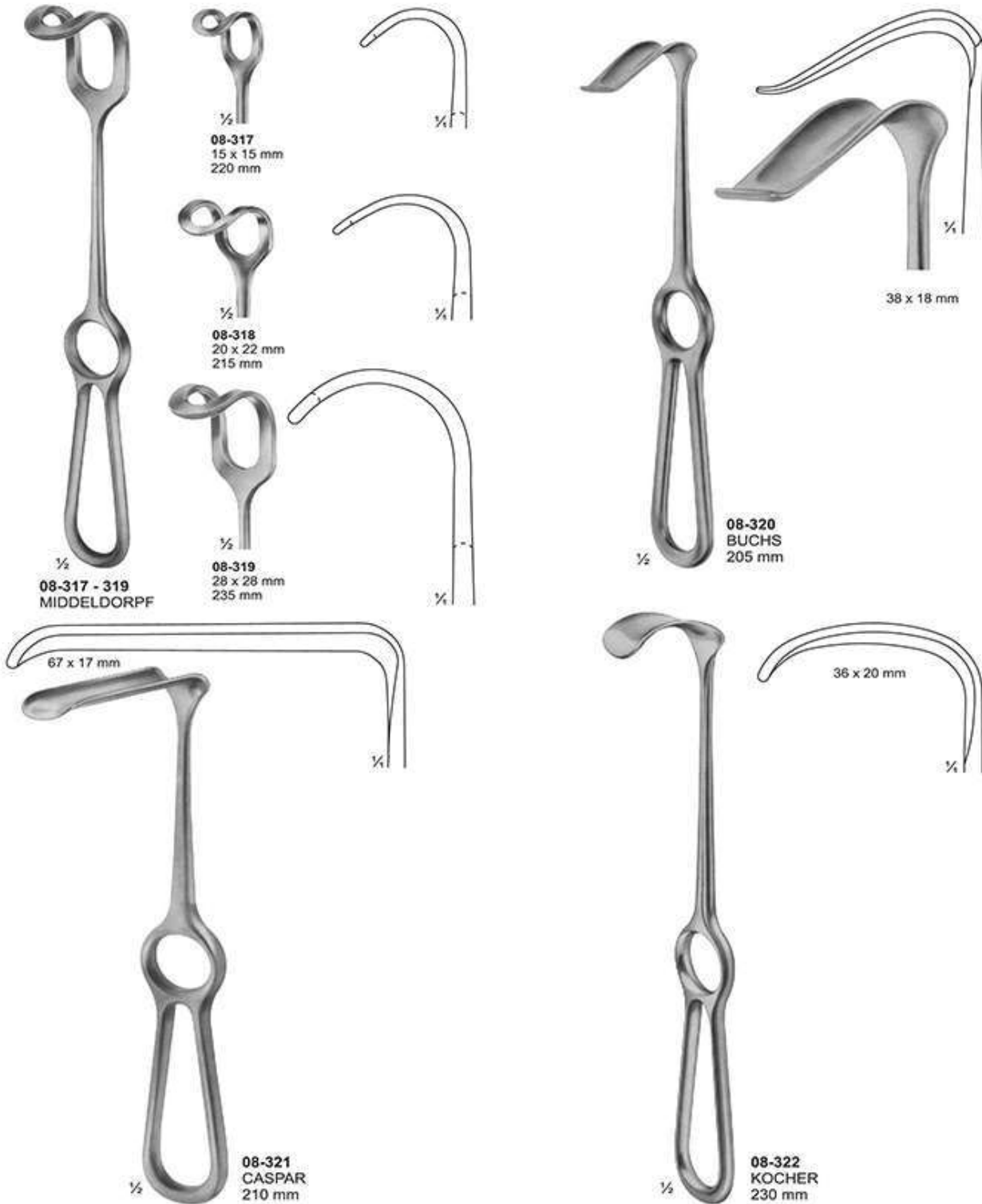

Retractors

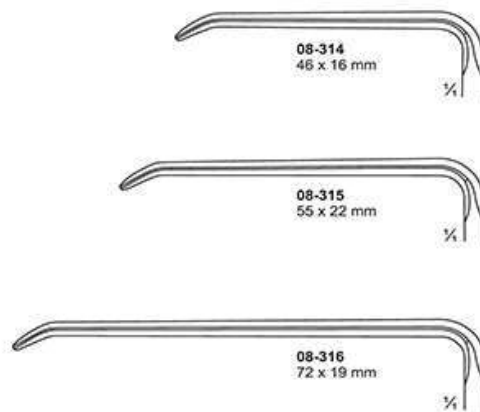
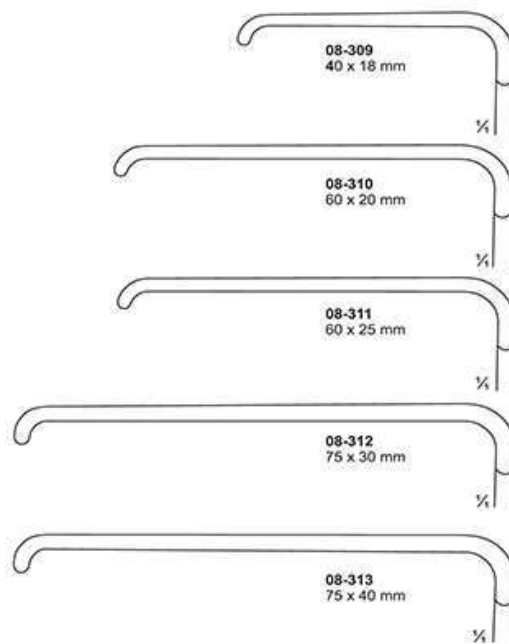

Retractors



08-295 - 300
LANGENBECK
210 mm
08-295 28 x 10 mm
08-296 28 x 14 mm
08-297 33 x 14 mm
08-298 28 x 16 mm
08-299 40 x 10 mm
08-300 40 x 13 mm



08-301 - 307
KOCHER-LANGENBECK
215 mm
08-301 25 x 6 mm
08-302 35 x 8 mm
08-303 35 x 11 mm
08-304 35 x 15 mm
08-305 41 x 11 mm
08-306 55 x 11 mm
08-307 70 x 14 mm

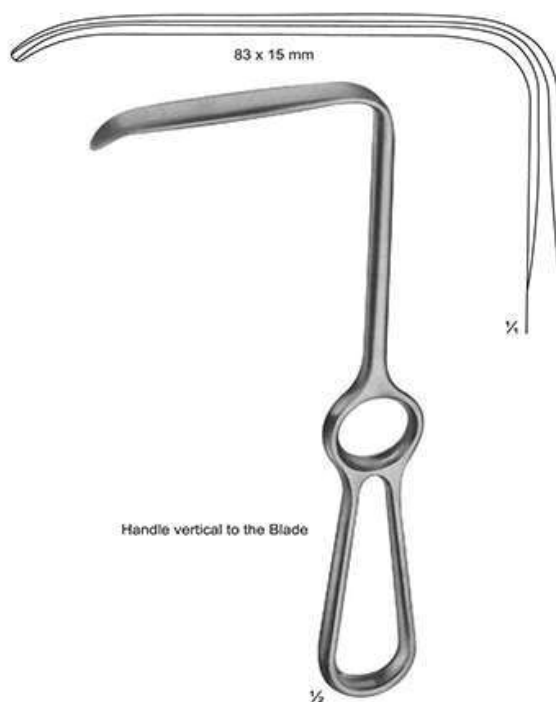

08-308
LANGENBECK
215 mm

Retractors, Deep form

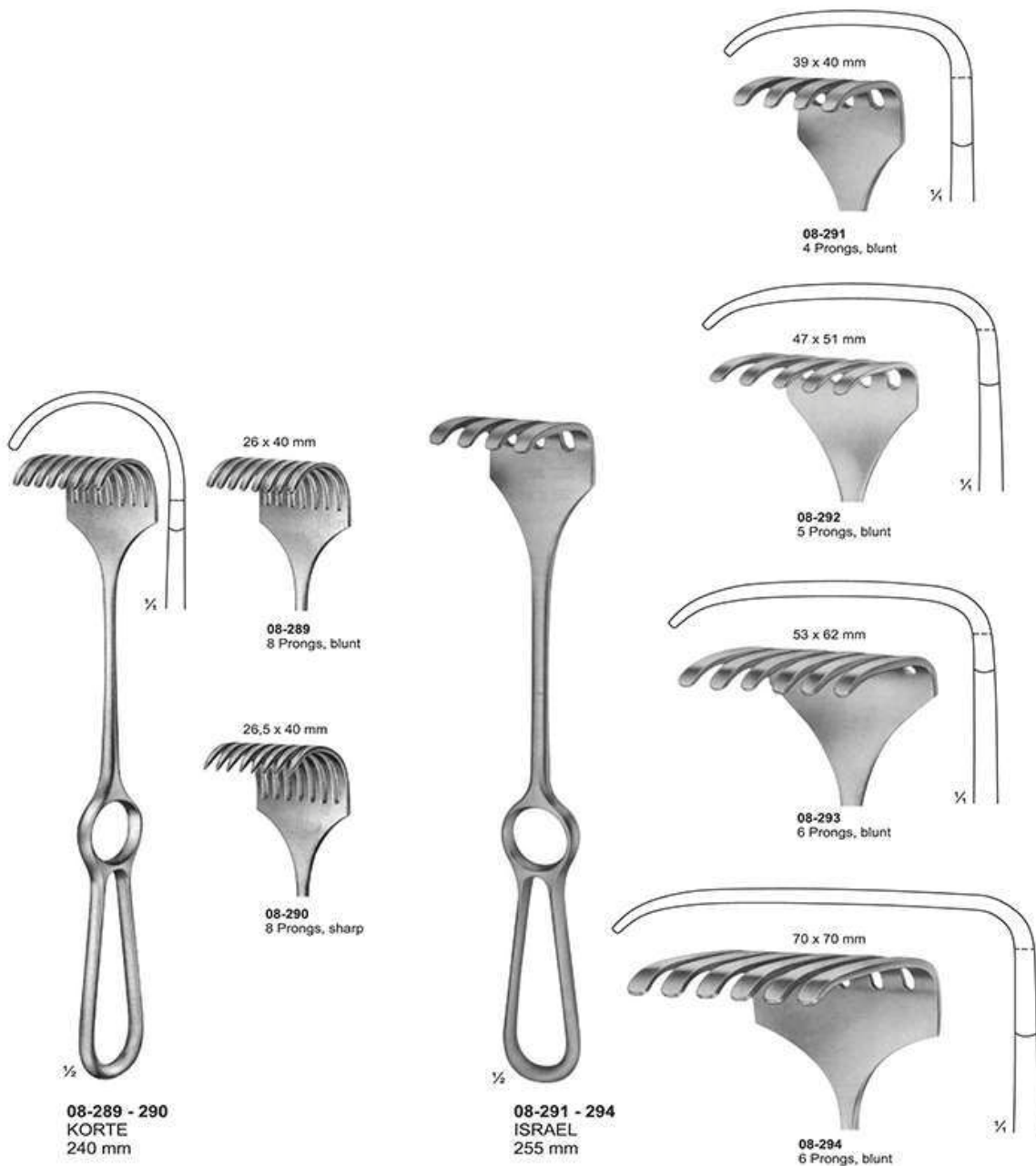

Retractors

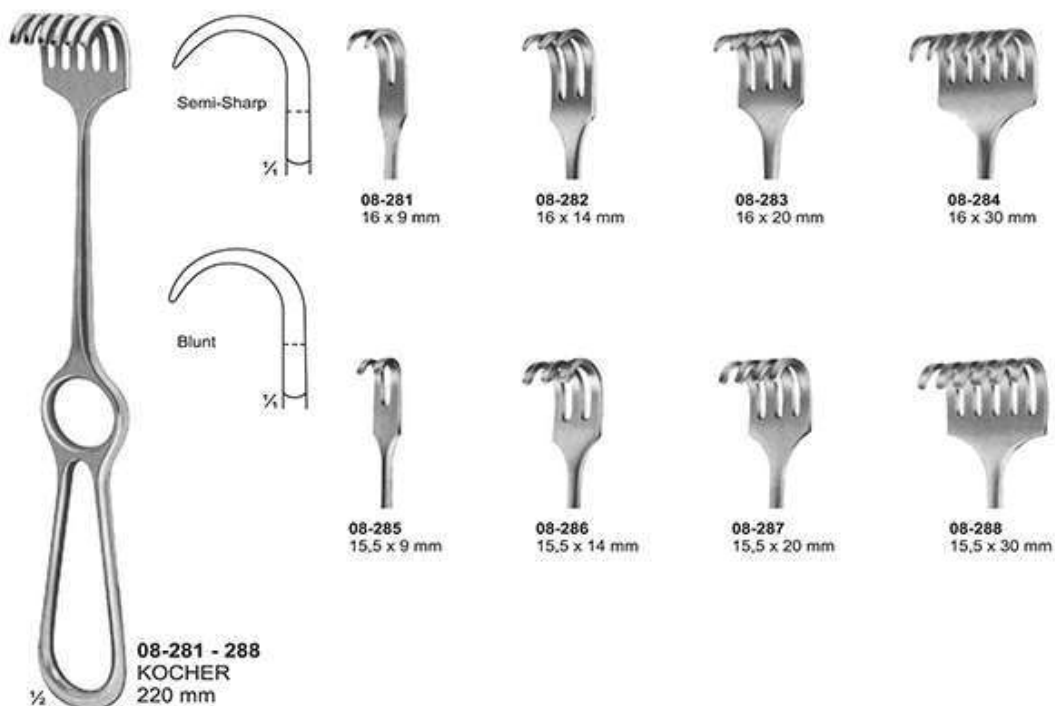
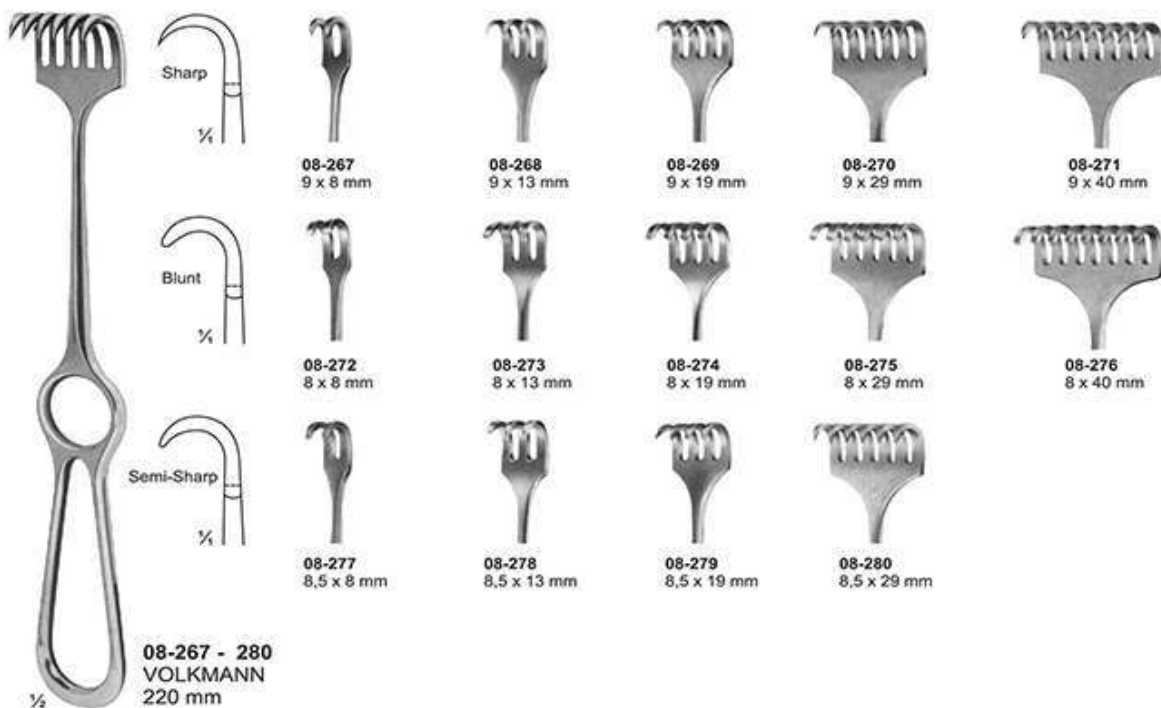

Bone Retractors and Retractors

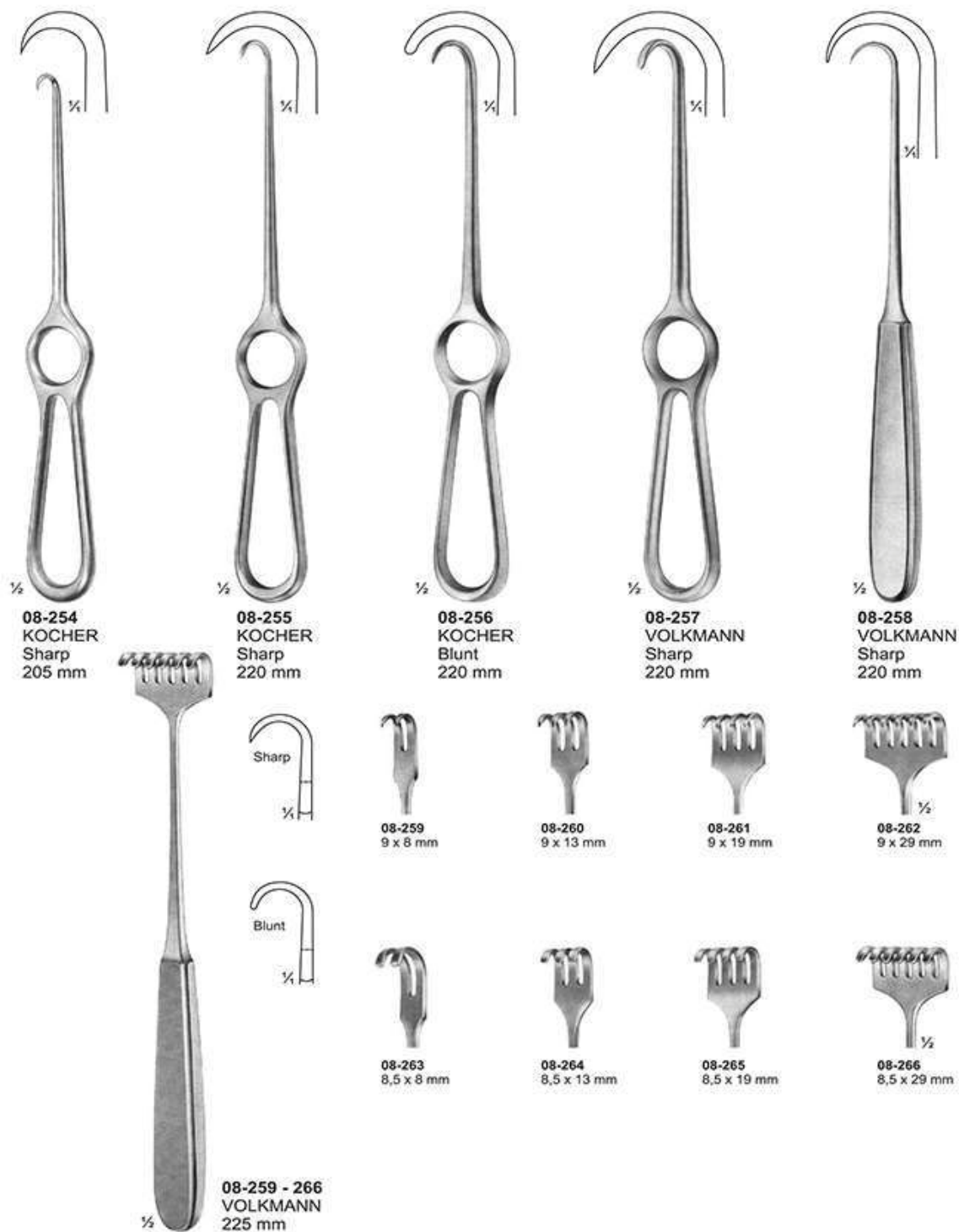

Retractors



Retractors

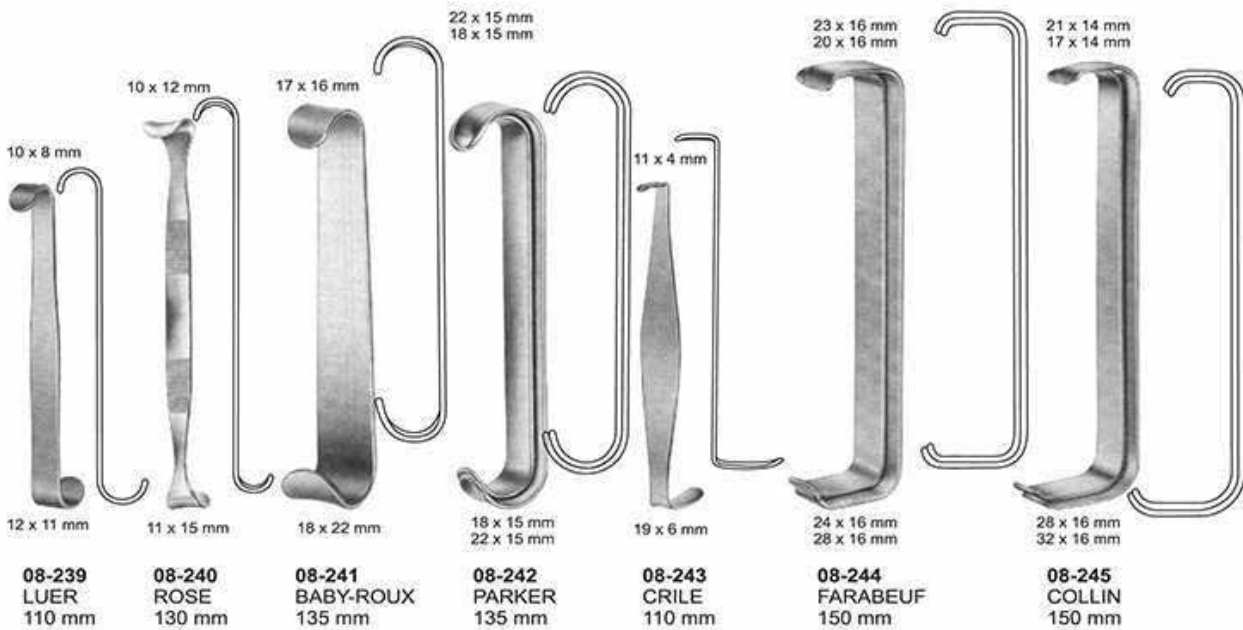

Retractors

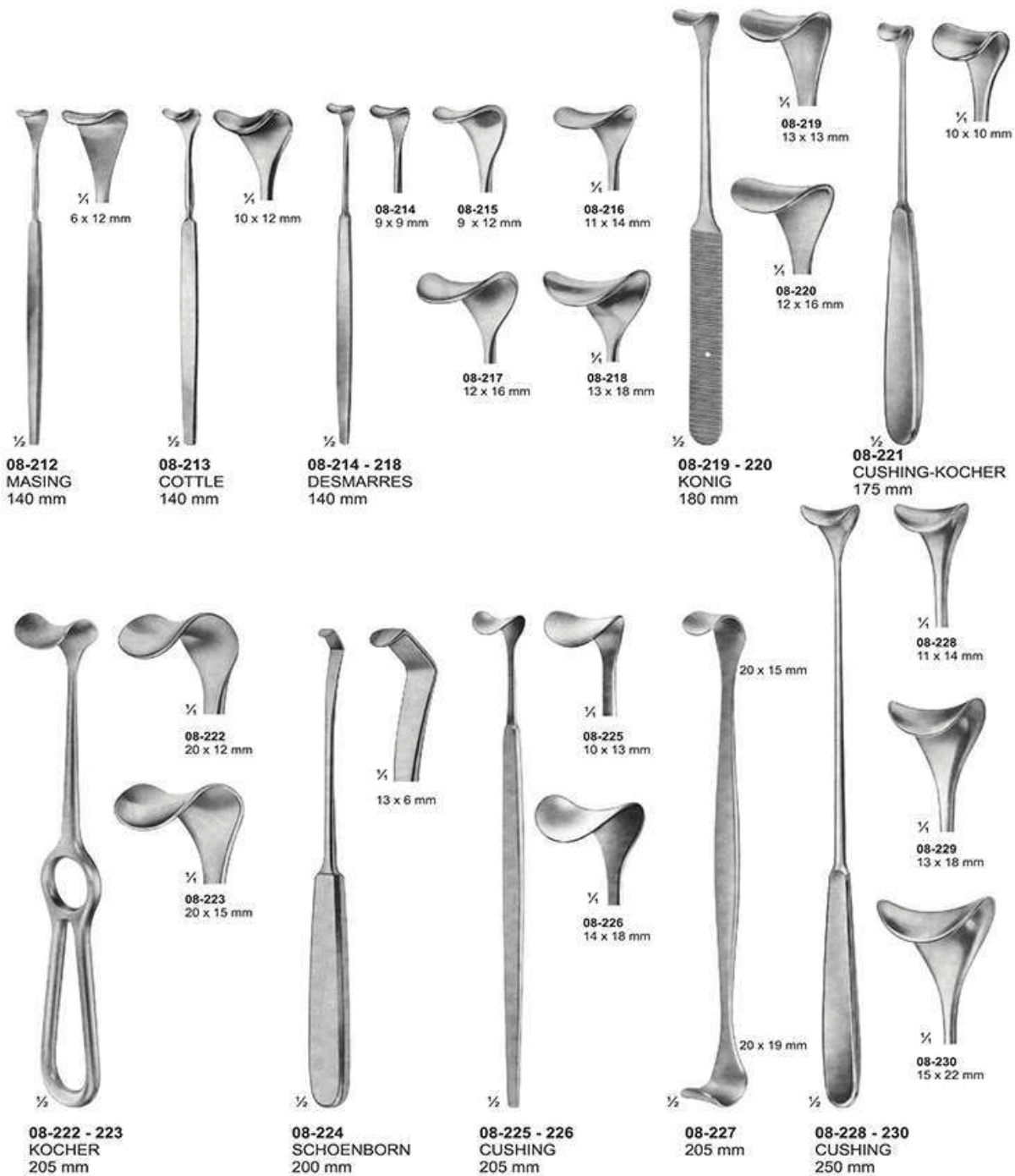

Retractors



08-205
EMMETT
Fistula hook
220 mm



08-206
SIMON
Fistula hook
220 mm

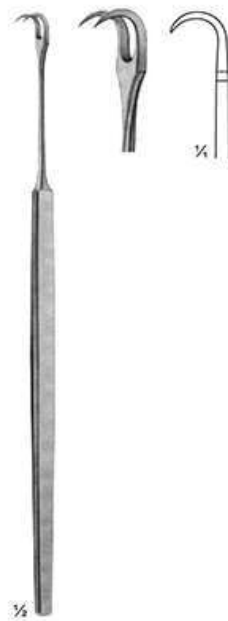

08-207
SIMON
Fistula hook
220 mm



08-208
LANGE
Fistula hook
230 mm

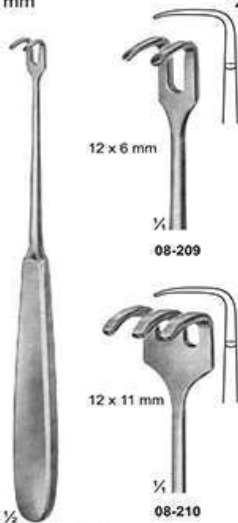

08-209 - 210
Tendon hooks
175 mm

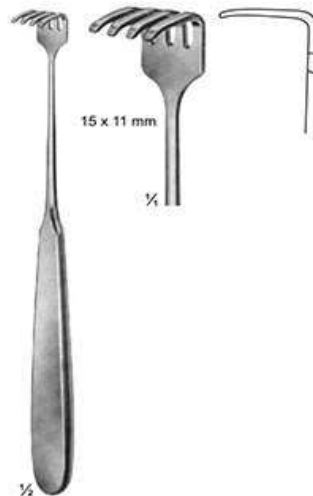

08-211
KLAPP
Tendon hooks
175 mm

Retractors

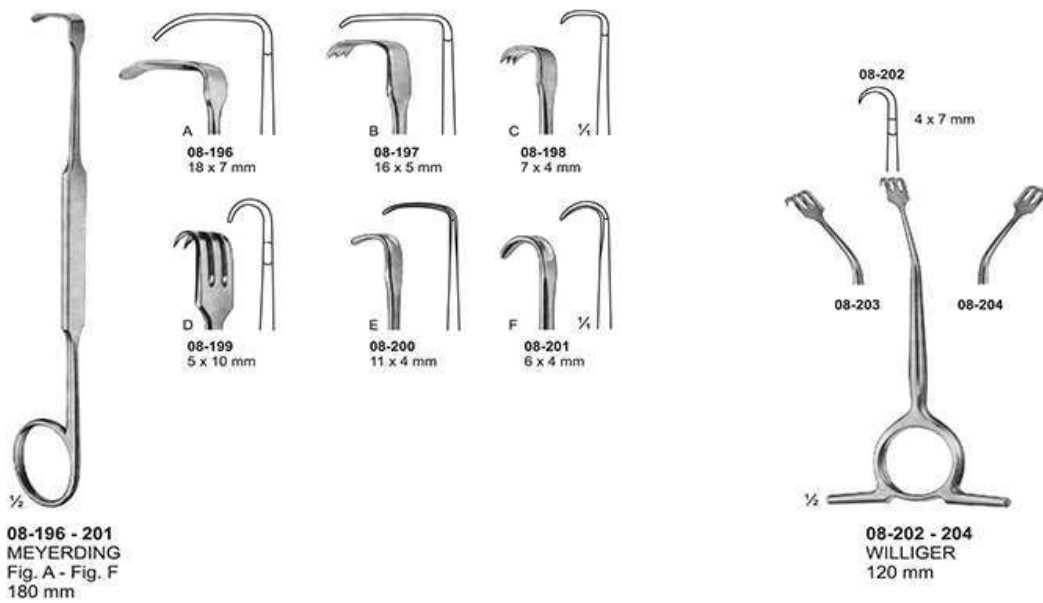

Retractors With Treanglr Handle

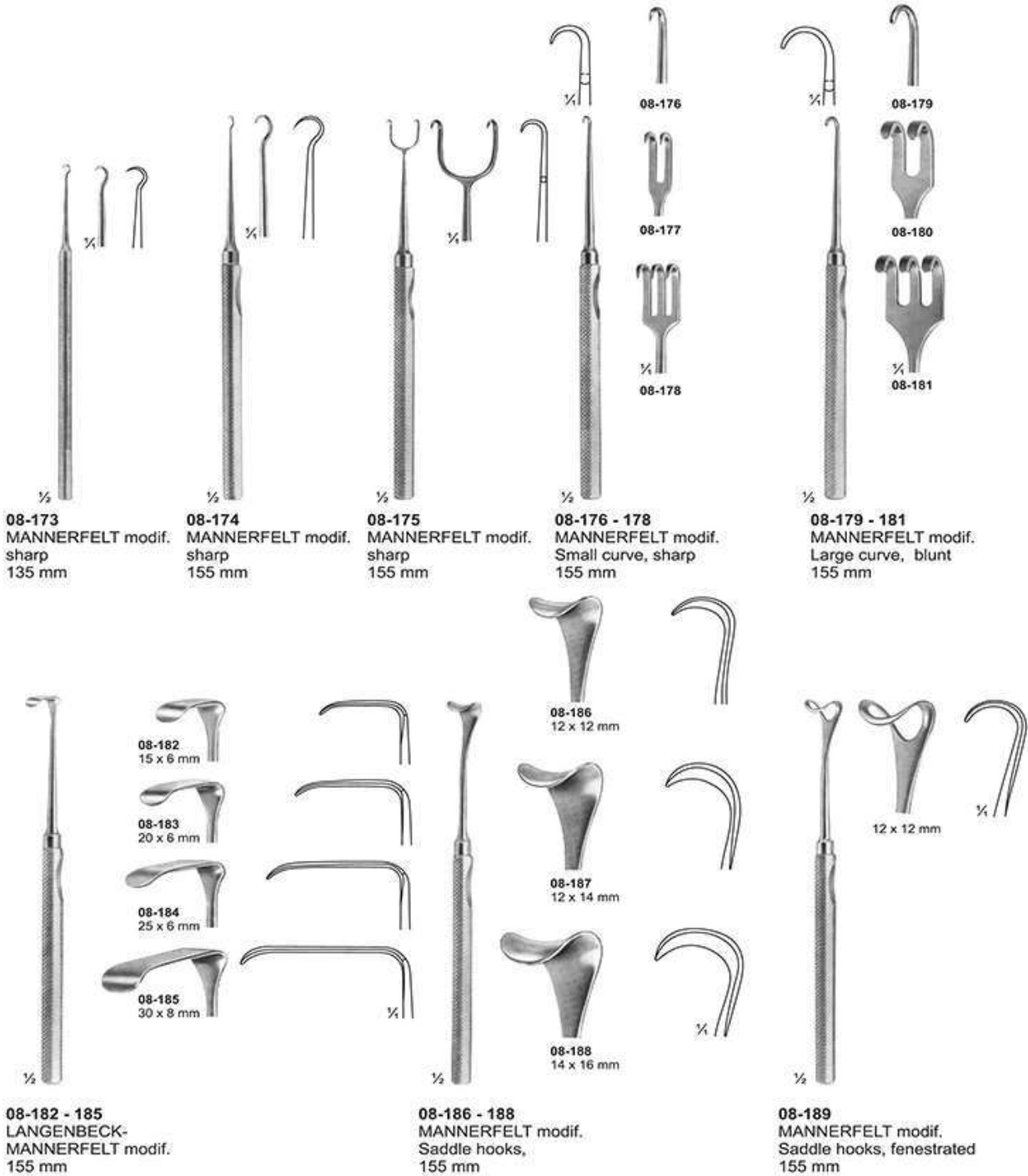

Wound - Trachea Retractors

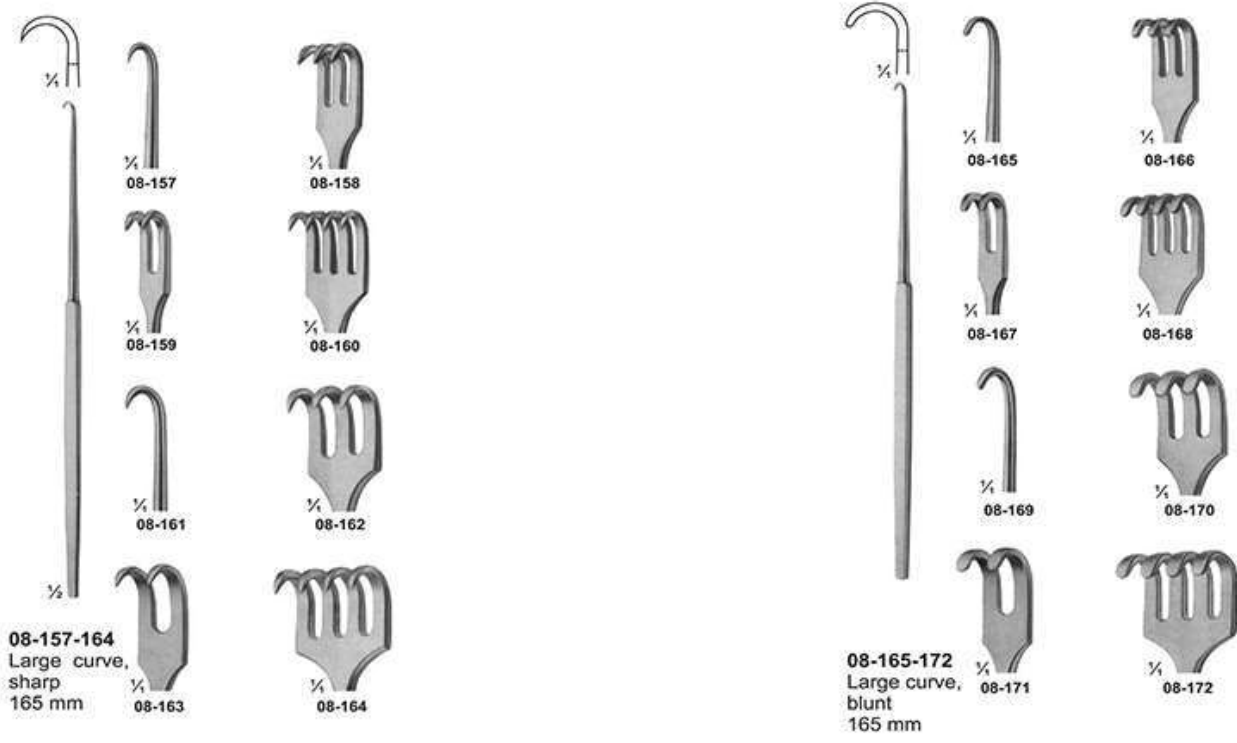
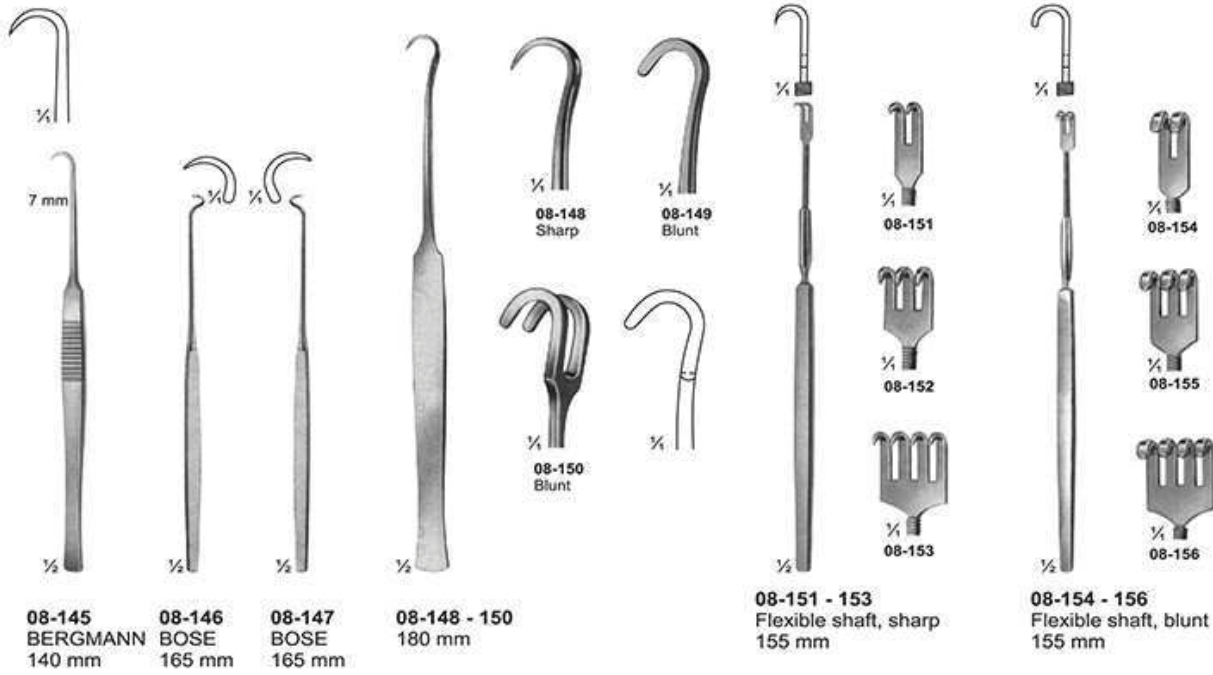

Fine Wound Retractors (Dura- and Skin Retractors)

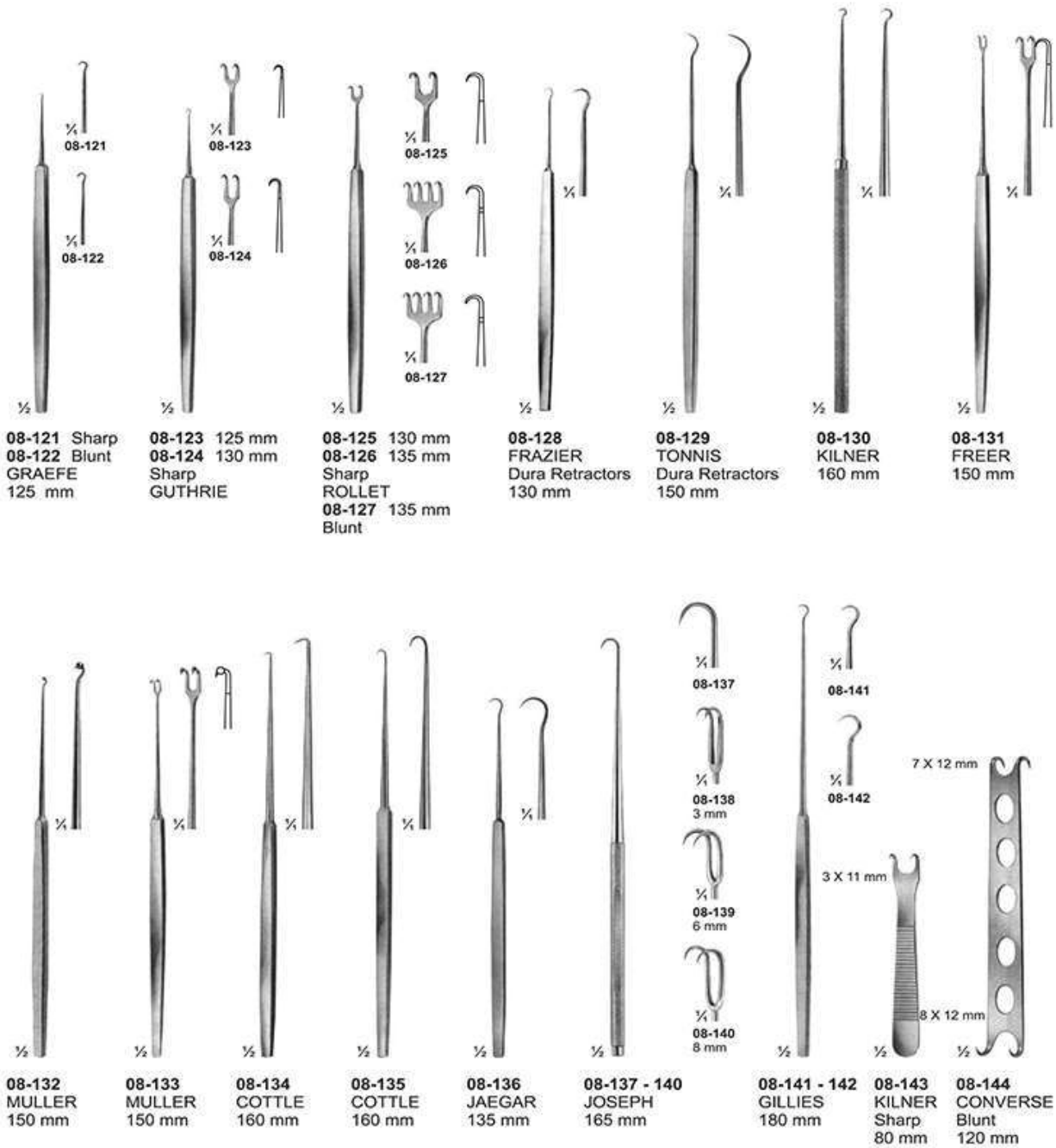

Nerve - and Vessel Hooks

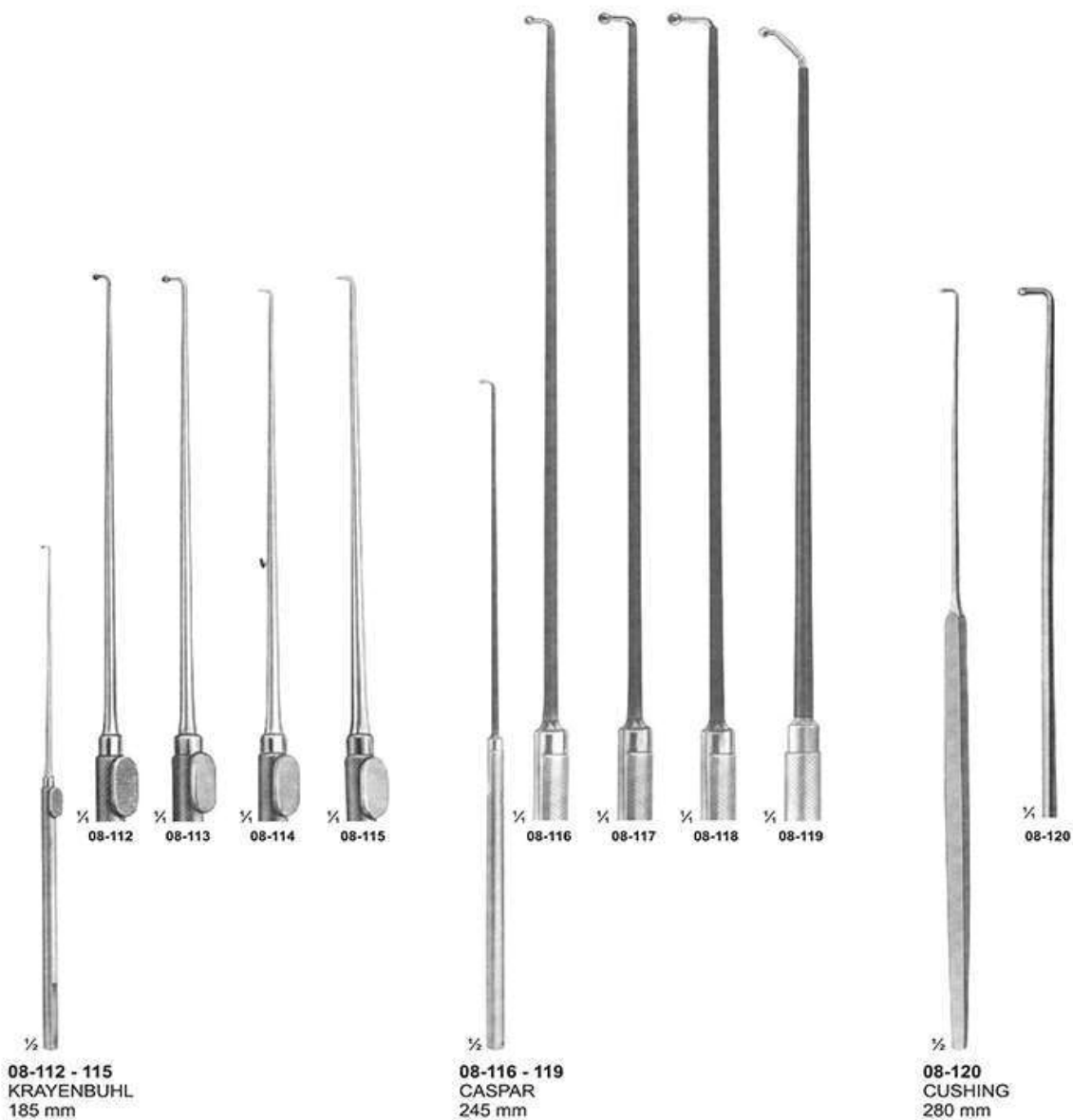

Nerve - and Vessel Hooks

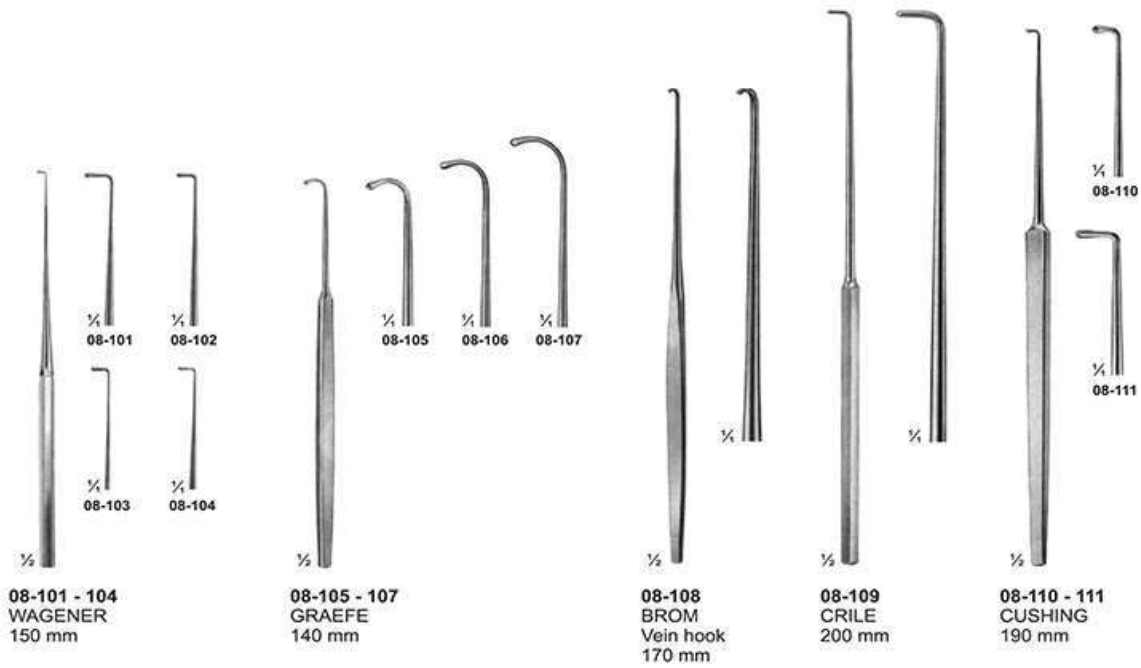

Clip Applying Forceps - Suture Set



07-295

Venae sectio set, in metal case
consisting of:

Bottom tray

- 1 MATHIEU needle holder, fine pattern 140mm
- 1 Ligature needle, fine short pattern
- 1 DOYEN director, curved
- 1 HEGENBARTH clip forceps,
- 1 ELSCHNIG tissue forceps, 1 x 2 teeth fine, 150mm
- 1 Dressing forceps, fine 105mm
- 1 Tissue forceps, 1 x 2 teeth, 110mm
- 1 Vessel scissors, straight, with 1 ball point, 110mm
- 1 Vessel scissors, curved, pointed 105mm
- 1 FINSEN retractor
- 1 Perforated needle case

Top tray

- 1 Scalpel, pointed
- 1 Scalpel, bellied
- 2 HALSTED mosquito forceps, curved, 125mm
- 2 HALSTED mosquito forceps, straight, 1x 2 teeth, 125mm
- 3 BACKHAUS towel forceps, 90mm
- 2 Flacon holder

Clip Applying Forceps - Suture Set



07-290

Suturing instruments set, in metal case consisting of: Scissors, curved, sharp/sharp, 115mm
25 MICHEL clip, 16 x 3mm
1 Delicate tissue forceps, 130mm
1 Scalpel, bellied
1 MATHIEU needle holder, 140mm
1 Perforated metal case, stainless containing:
1 Suture needle
1 item 1 item



07-291

Pocket instrument set, in metal case consisting of:

Bottom tray

1 MATHIEU needle holder, 140mm
1 MICHEL clip forceps, combined
1 Myrtle leaf probe, 130mm
1 Sharp double curette
1 Skin hook
1 Detachable scalpel handle, no.4
1 Perforated metal case, containing
6 Scalpel blades BB 520
1 Perforated metal case, stainless, containing
1 Suture needle
1 item
1 item

Top tray

1 Tissue forceps, 130mm
1 KOCHER haemostatic forceps, 130mm
1 Straight surgical scissors, 130mm
1 Dissecting forceps, 130mm
1 FEILCHENFELD splinter forceps, 115mm
25 MICHEL clip, 16 x 3mm
1 Flacon of suture skin, sterile in alcohol



07-292

Pocket instrument set, in metal case consisting of:

Bottom tray

1 MAYO-HEGER needle holder, 150mm
1 MICHEL clip forceps, combined
1 Myrtle leaf probe, 130mm
1 Sharp double curette
1 Skin hook
1 Detachable scalpel handle, no. 4
1 Perforated metal case, consisting
6 Scalpel blades BB 520
1 Perforated metal case, stainless, consisting:
1 Suture needle
1 item & 1 item

Bottom tray

1 Tissue forceps, 130mm
1 CRILE haemostatic forceps, 140mm
1 Straight surgical scissors, 130mm
1 Dissecting forceps, 130mm
1 FEILCHENFELD splinter forceps, 115mm
25 MICHEL clip, 16 x 3mm
1 Flacon of suture silk, sterile in alcohol



Clip Applying Forceps - Suture Set



07-282
MICHEL
125 mm



07-283
HEGENBARTH
120 mm



07-284
WACHENFELDT
120 mm



07-285
WACHENFELDT
120 mm



07-286
MICHEL
125 mm



07-287
MICHEL modif.
130 mm



07-288
HEATH
135 mm



07-289
COLLIN
135 mm

Probes - Spatulas - Cotton Applicators

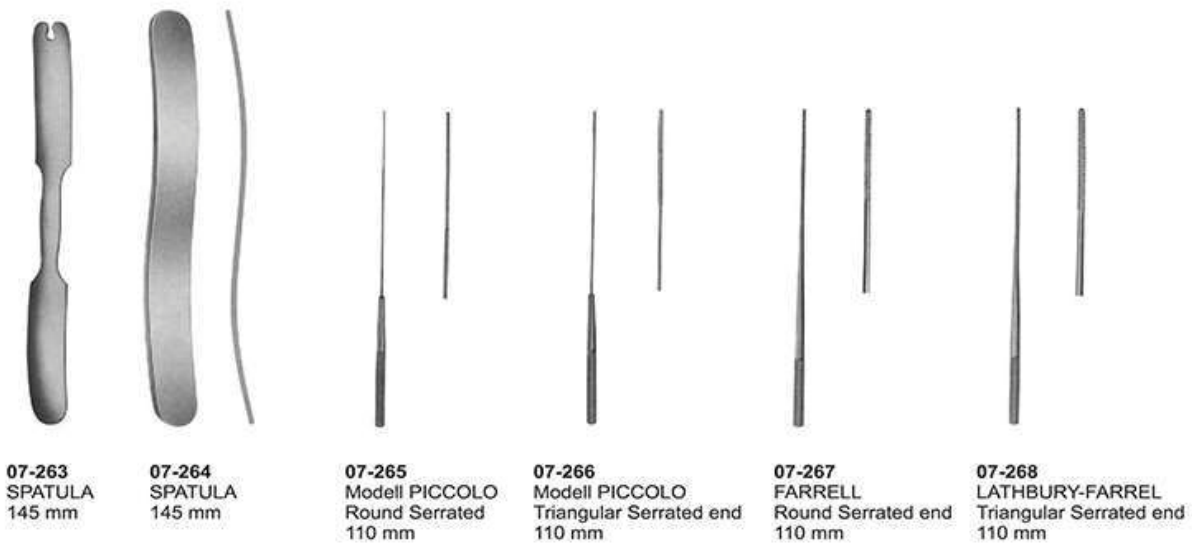
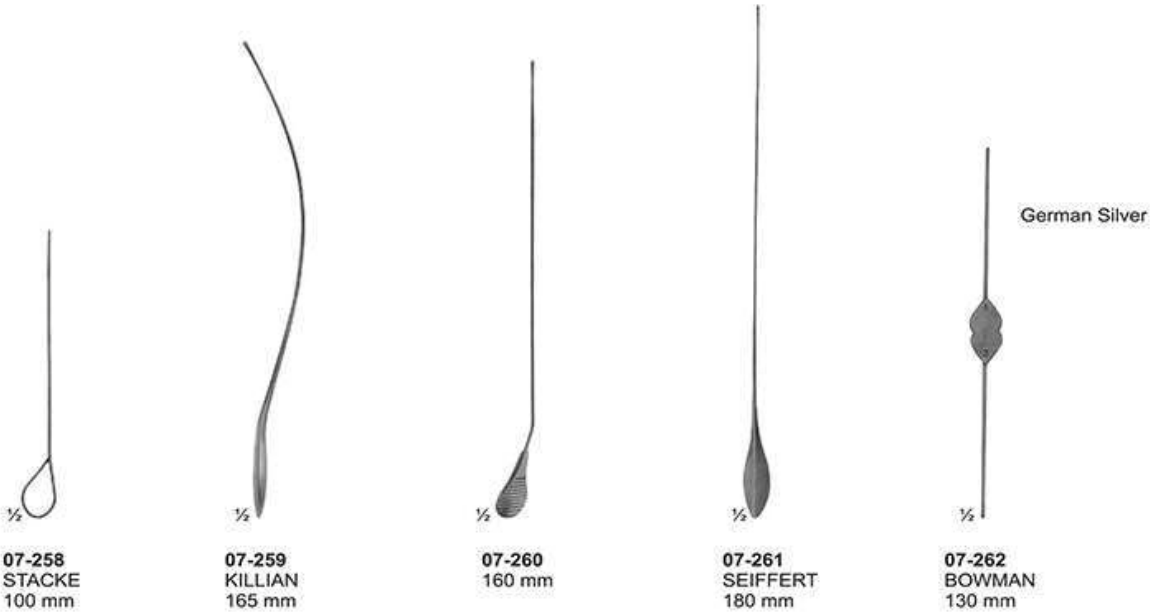

Guiding Probes

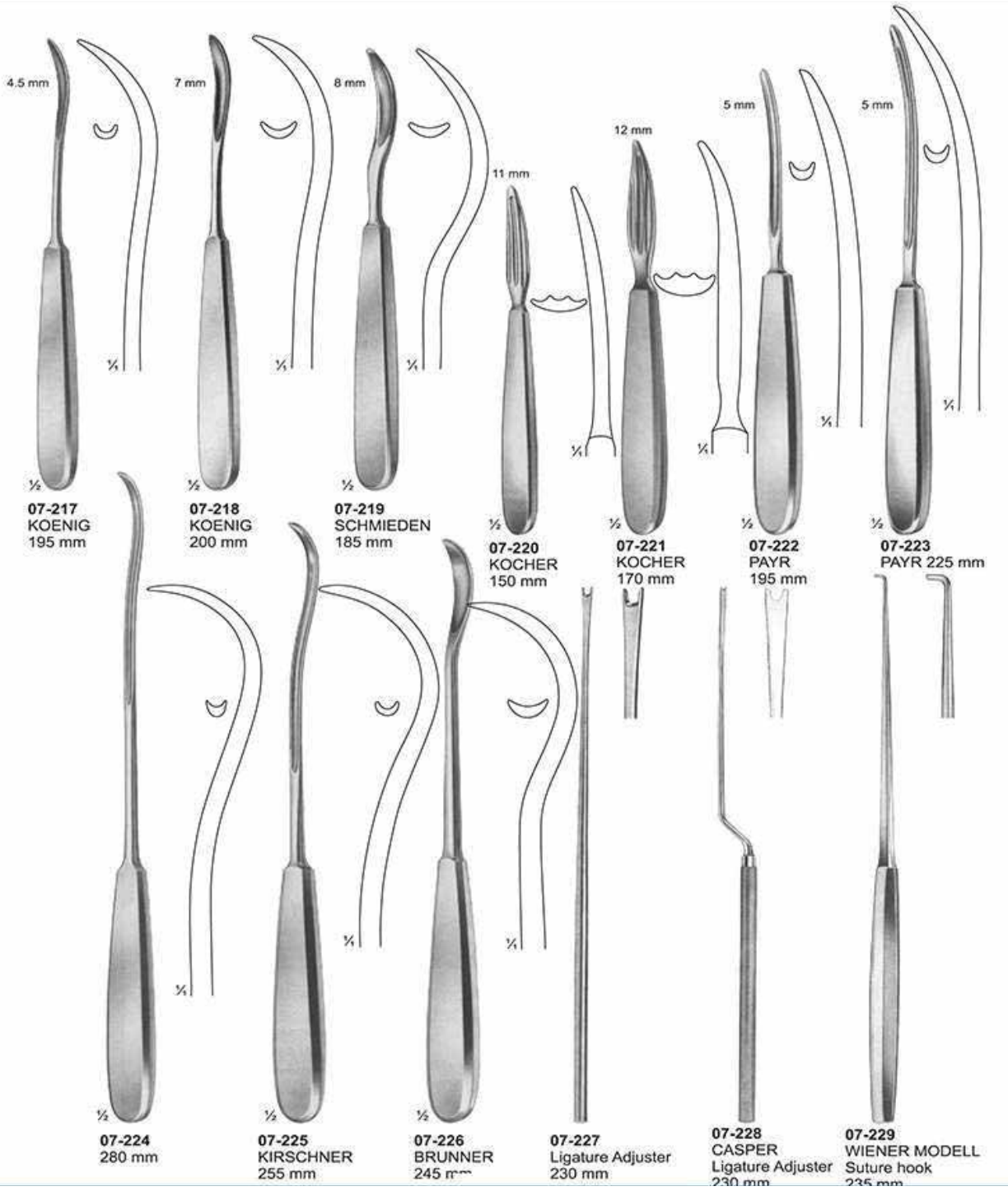

Ligature Needles

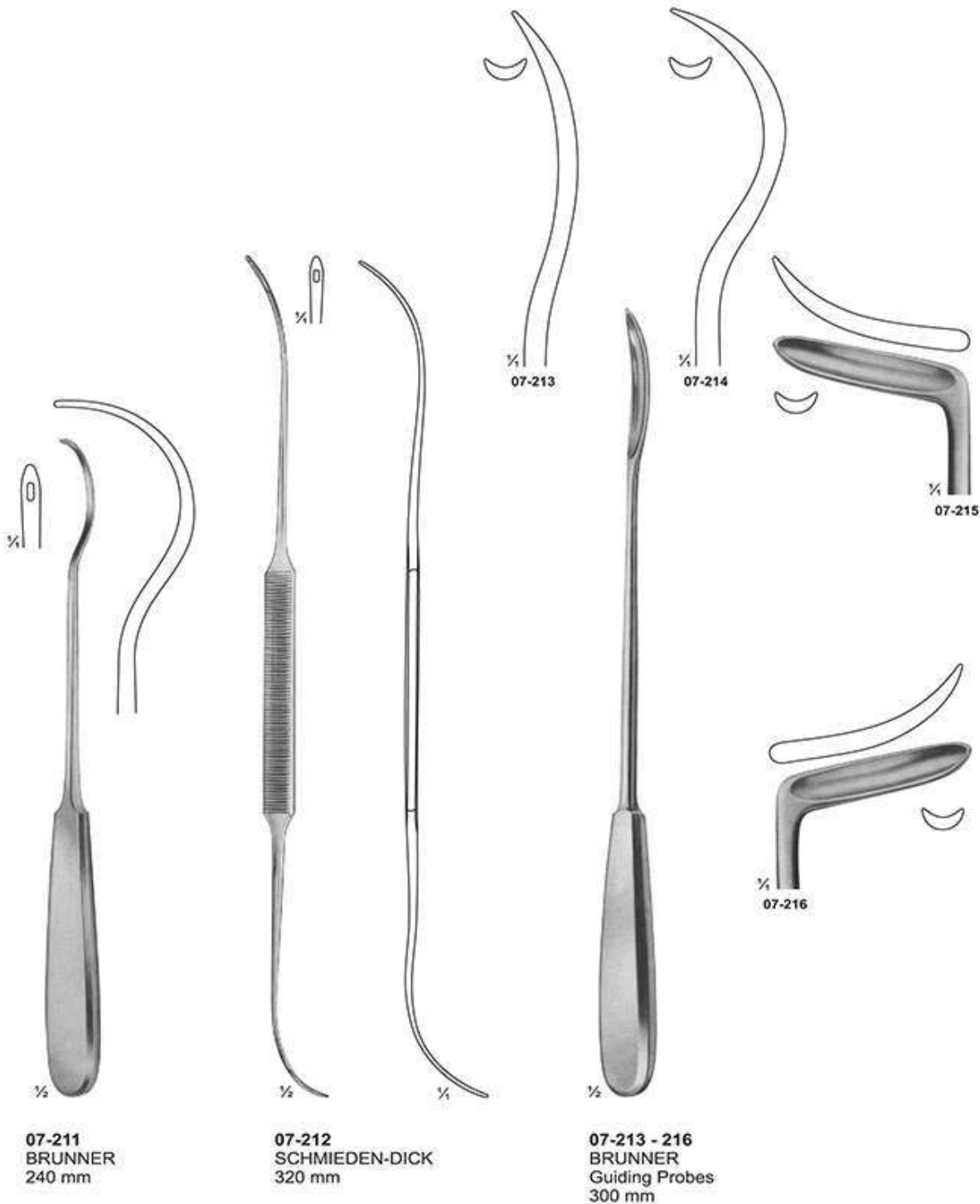

Suture Instruments - Ligature Needles

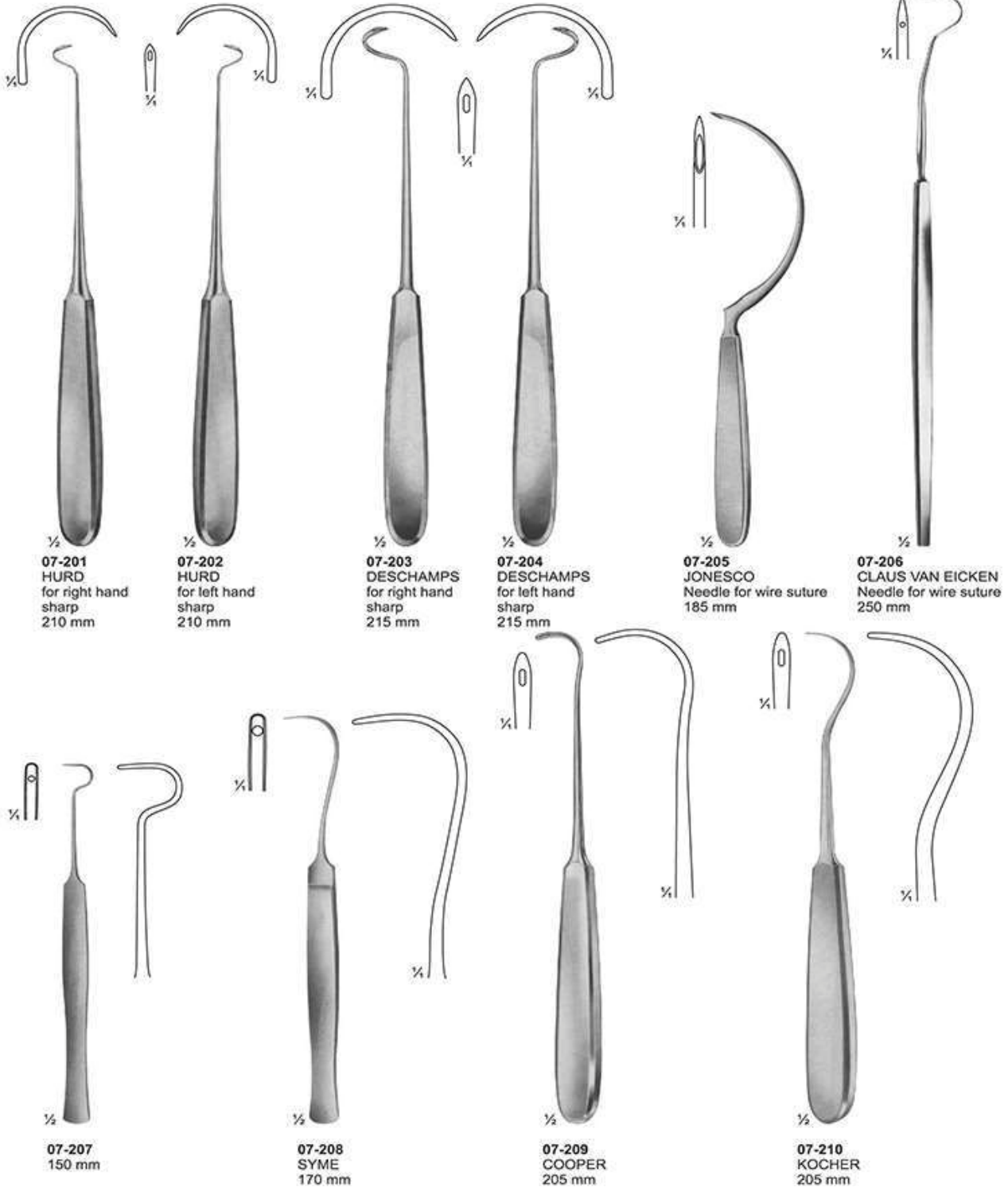

Suture Instruments - Ligature Needles

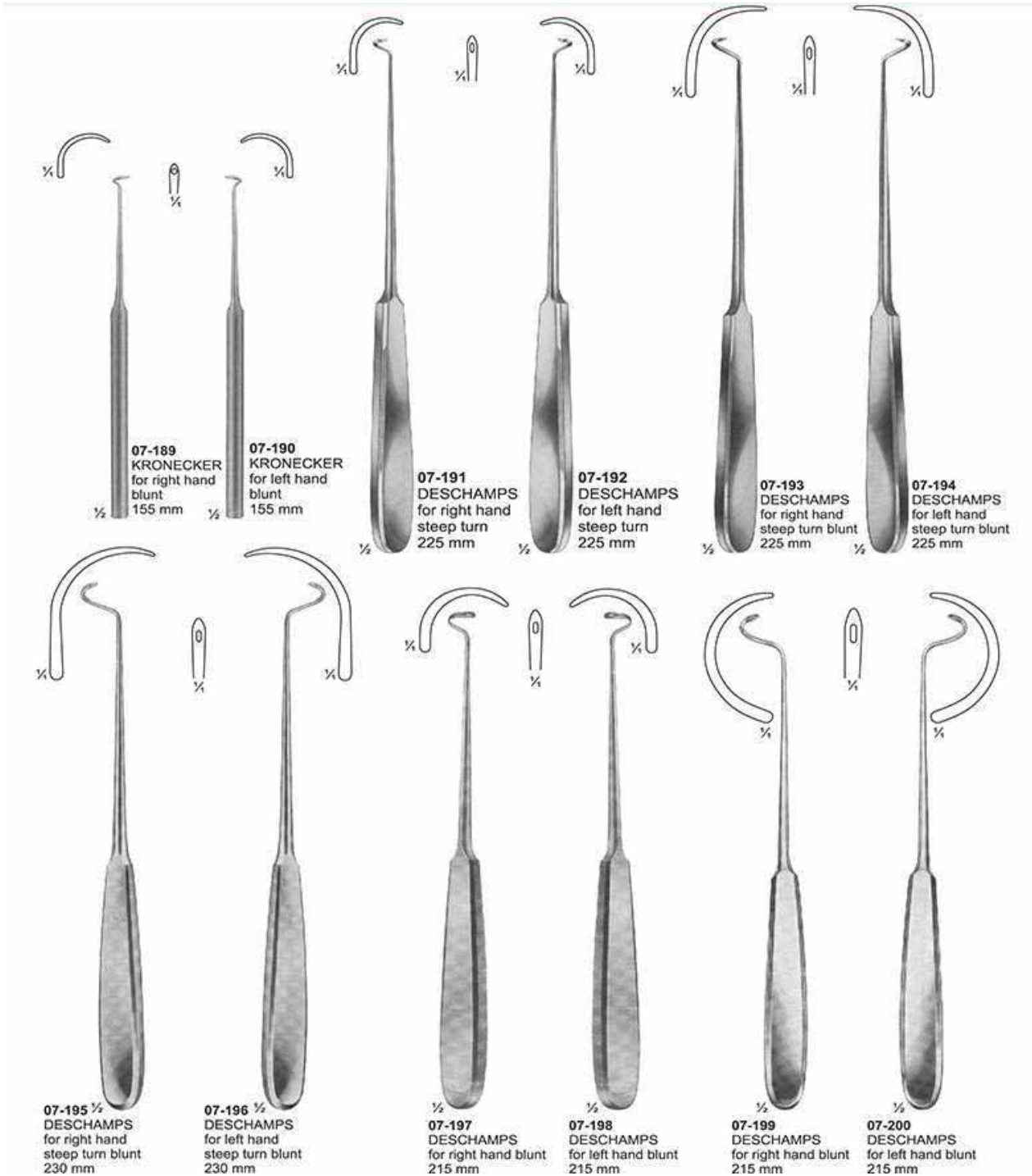

Suture Instruments - Reverdin Needles

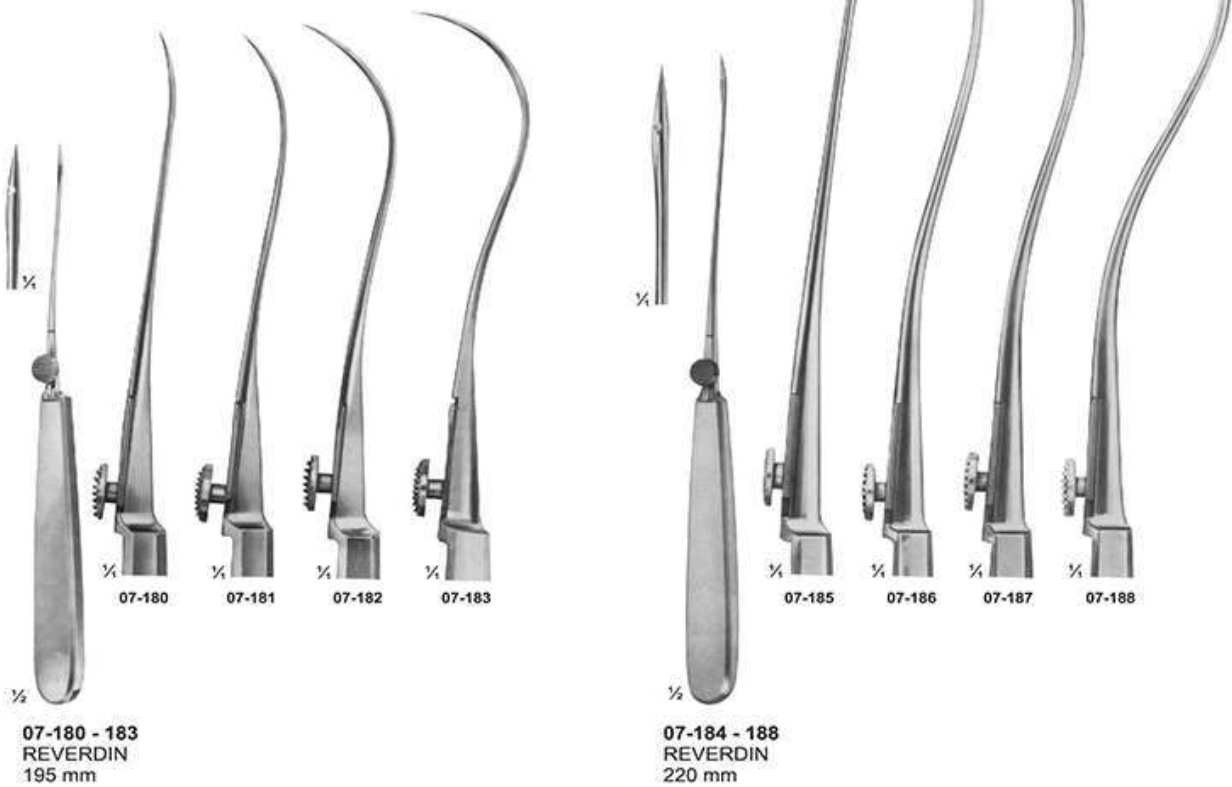
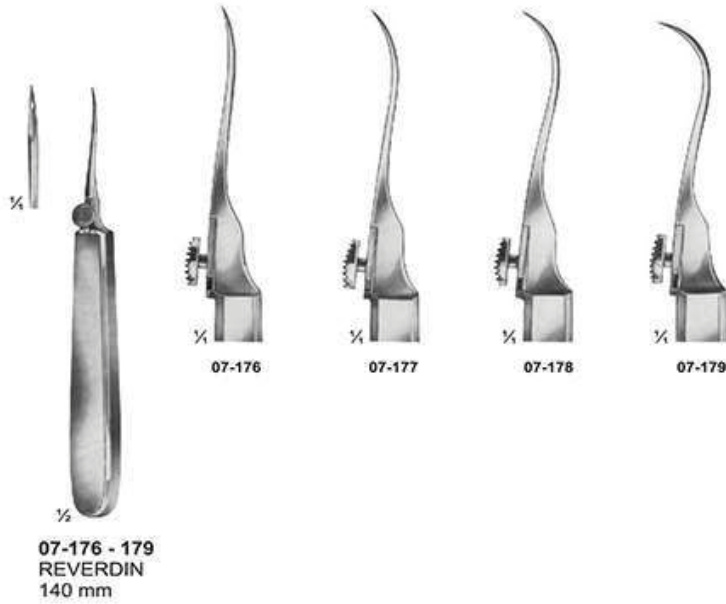

Needle Holders

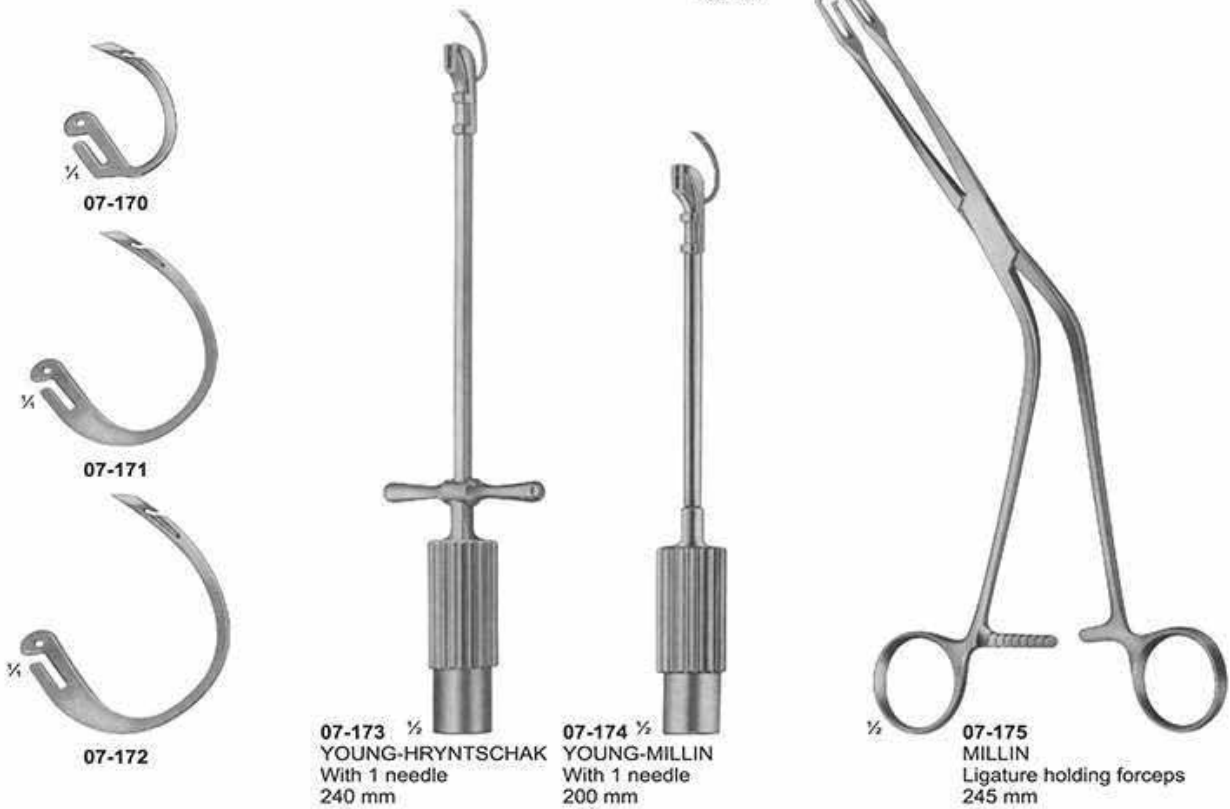
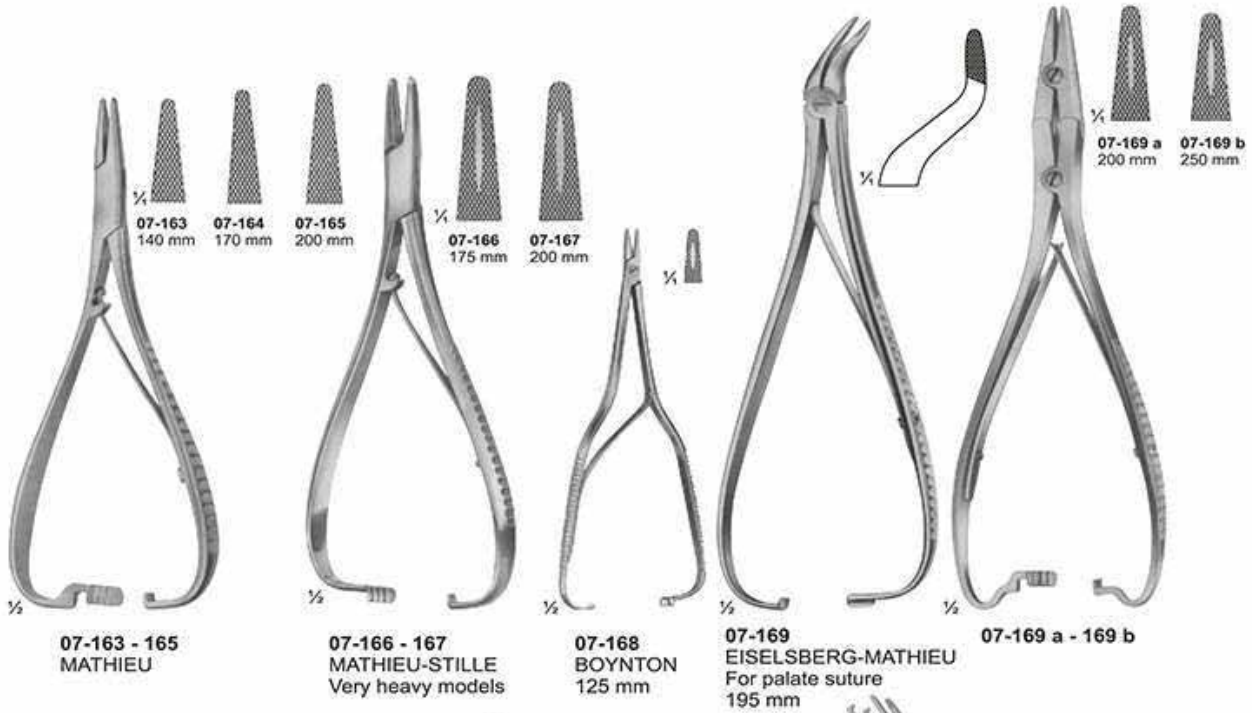

Needle Holders

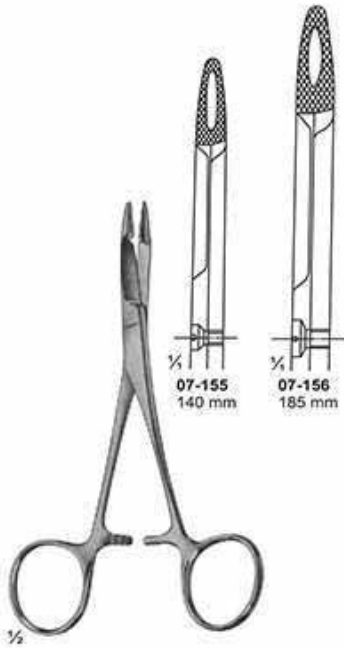

07-155 - 156
HEGAR-OLSEN
255 mm

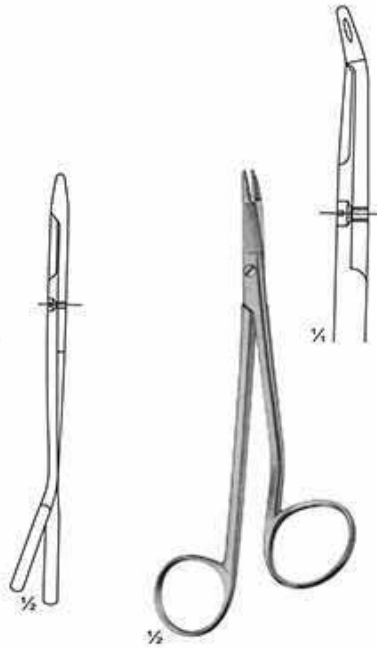

07-157
GILLIES
150 mm

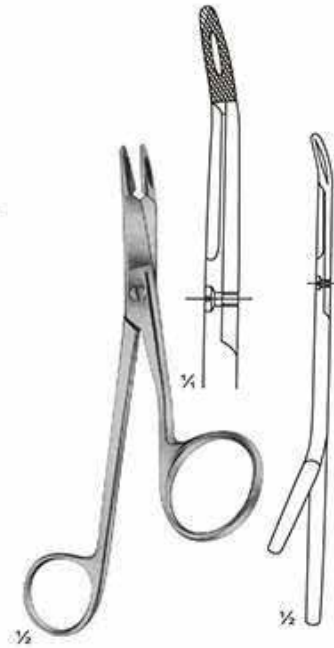

07-158
GILLIES
160 mm



07-159
EISELBERG
115 mm

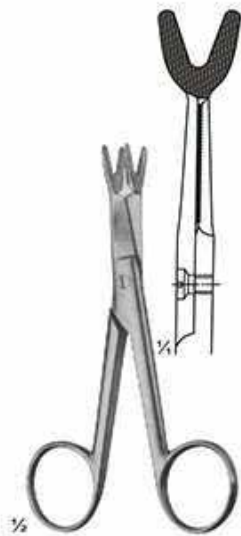

07-160
SCHOEMAKER-LOTH
125 mm



07-161
CRILE
150 mm



07-162
TONNIS
Elastic pattern for
dura-or intestinal suture
180 mm

Needle Holders

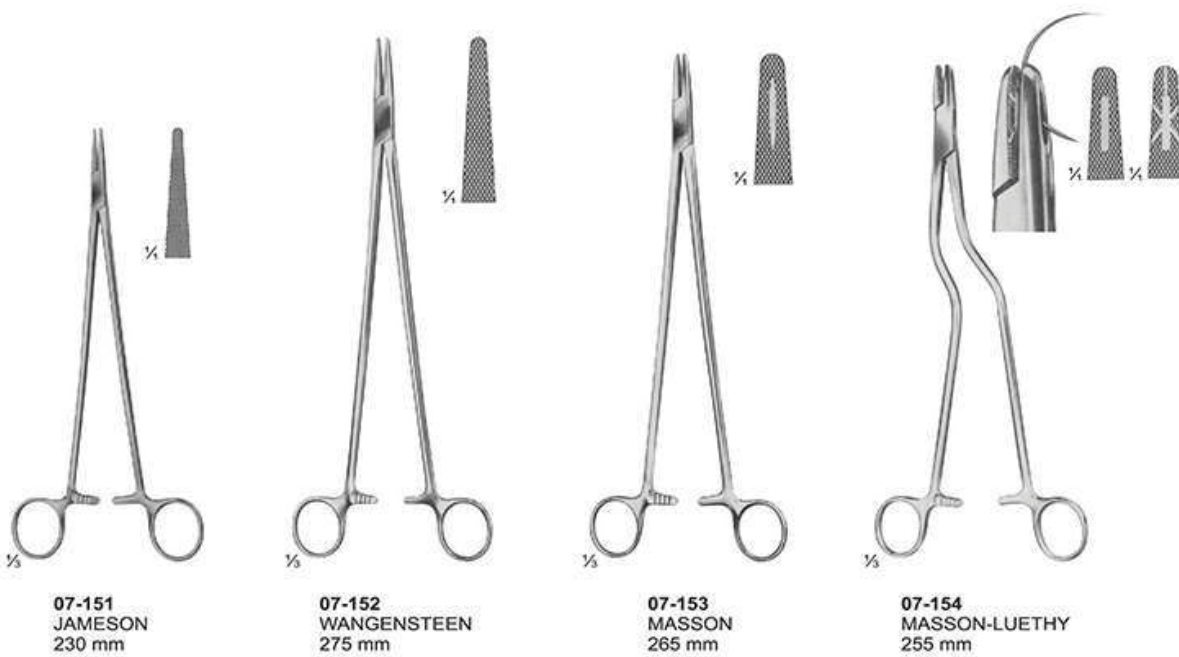

Needle Holders

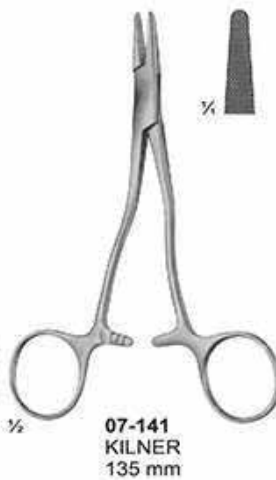
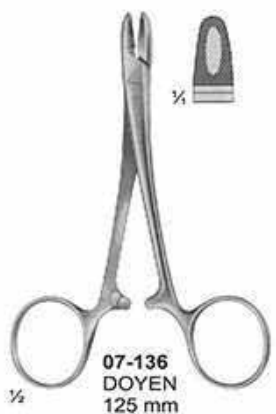
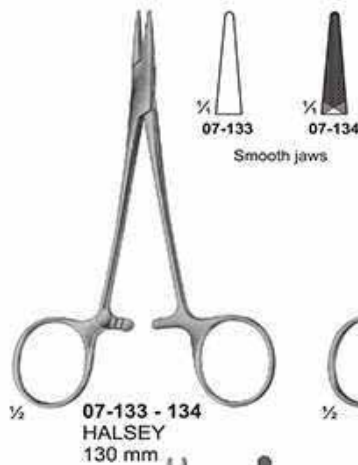

Micro Needle Holders With Round Handles

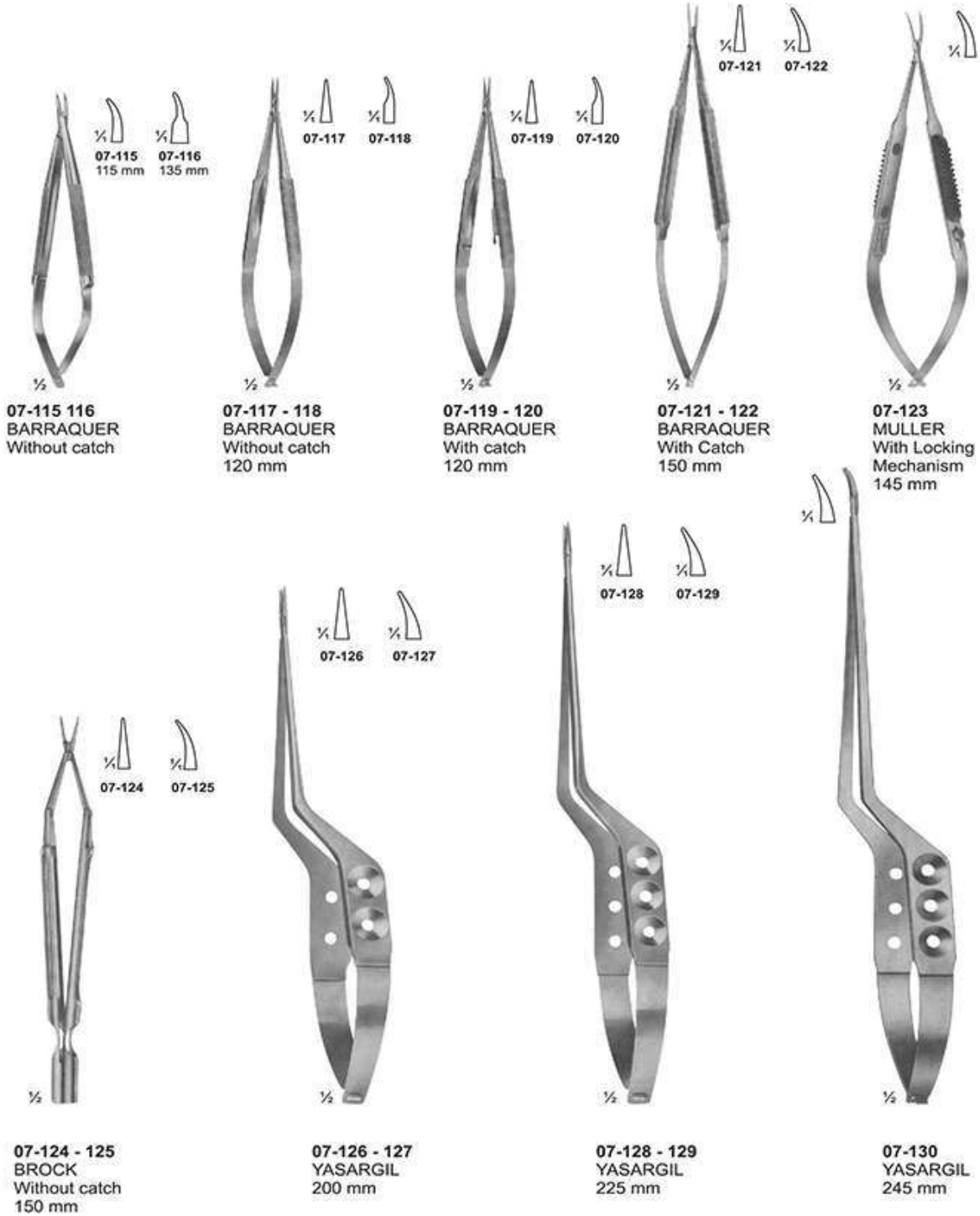

Needle Holders For Micro Surgery

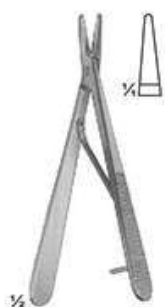

07-101
ROHRSCHEIDER
With copper inserts
100 mm



07-102
KALT
With catch
135 mm



07-103
ARRUGA
With catch
135 mm



07-104 - 105
CASTROVIEJO
With catch
145 mm



07-106 - 107
CASTROVIEJO
With Catch
160 mm



07-108 - 109
YASARGIL
Without catch
185 mm



07-109



07-110 - 111
JACOBSON
185 mm



07-110



07-111

Without catch

With catch



07-112
YASARGIL
Without catch
195 mm



07-113 - 114
YASARGIL
With catch
200 mm

07-113

07-114

Hysterectomy Forceps and Vaginal Clamps and Compression Forceps

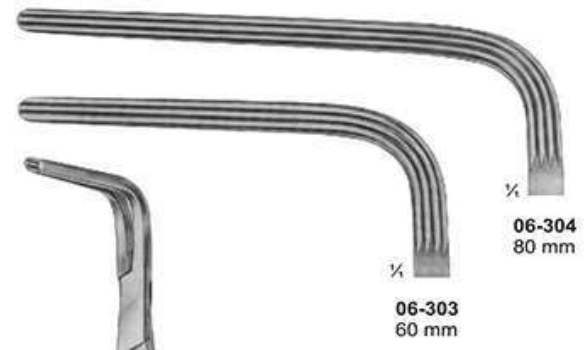

Hysterectomy Forceps and Vaginal Clamps and Compression Forceps



06-296
WERTHEIM
Hysterectomy Forceps
255 mm

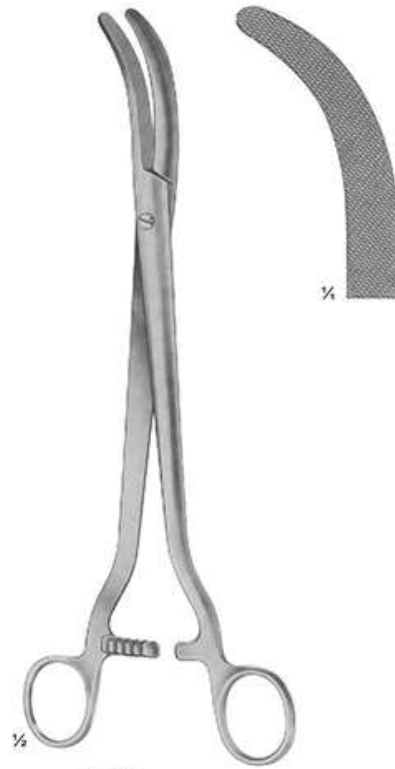

06-297
WERTHEIM
Parametrium Clamp
260 mm



06-298 - 300
DICK



06-298 255 mm
06-299 265 mm
06-300 275 mm

Hysterectomy Forceps and Vaginal Clamps

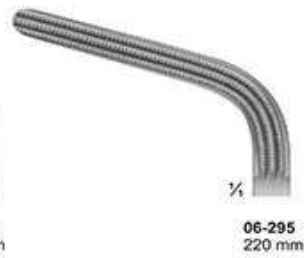
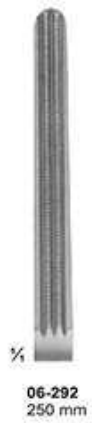
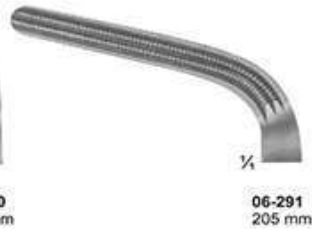

Hysterectomy Forceps



06-280 - 281
PHANEUF

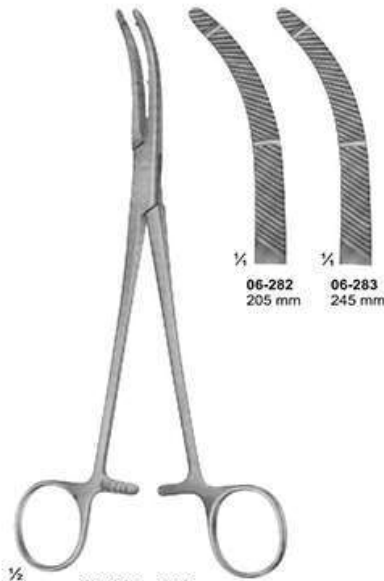

06-282 - 283
HEANEY modif.



06-284
HEANEY

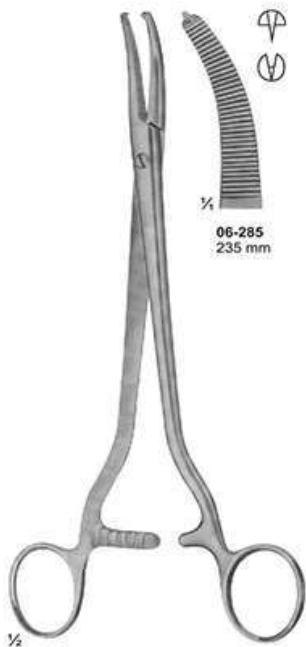

06-285
WERTHEIM

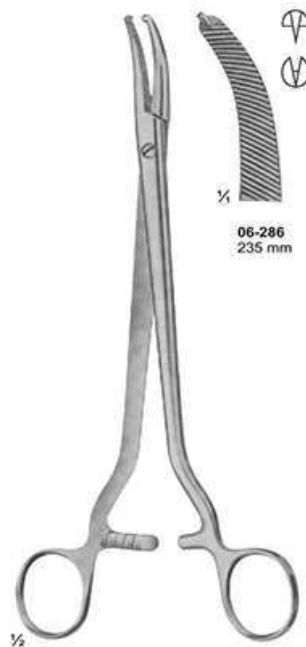

06-286
WERTHEIM



06-287
WERTHEIM

Peritoneum Forceps

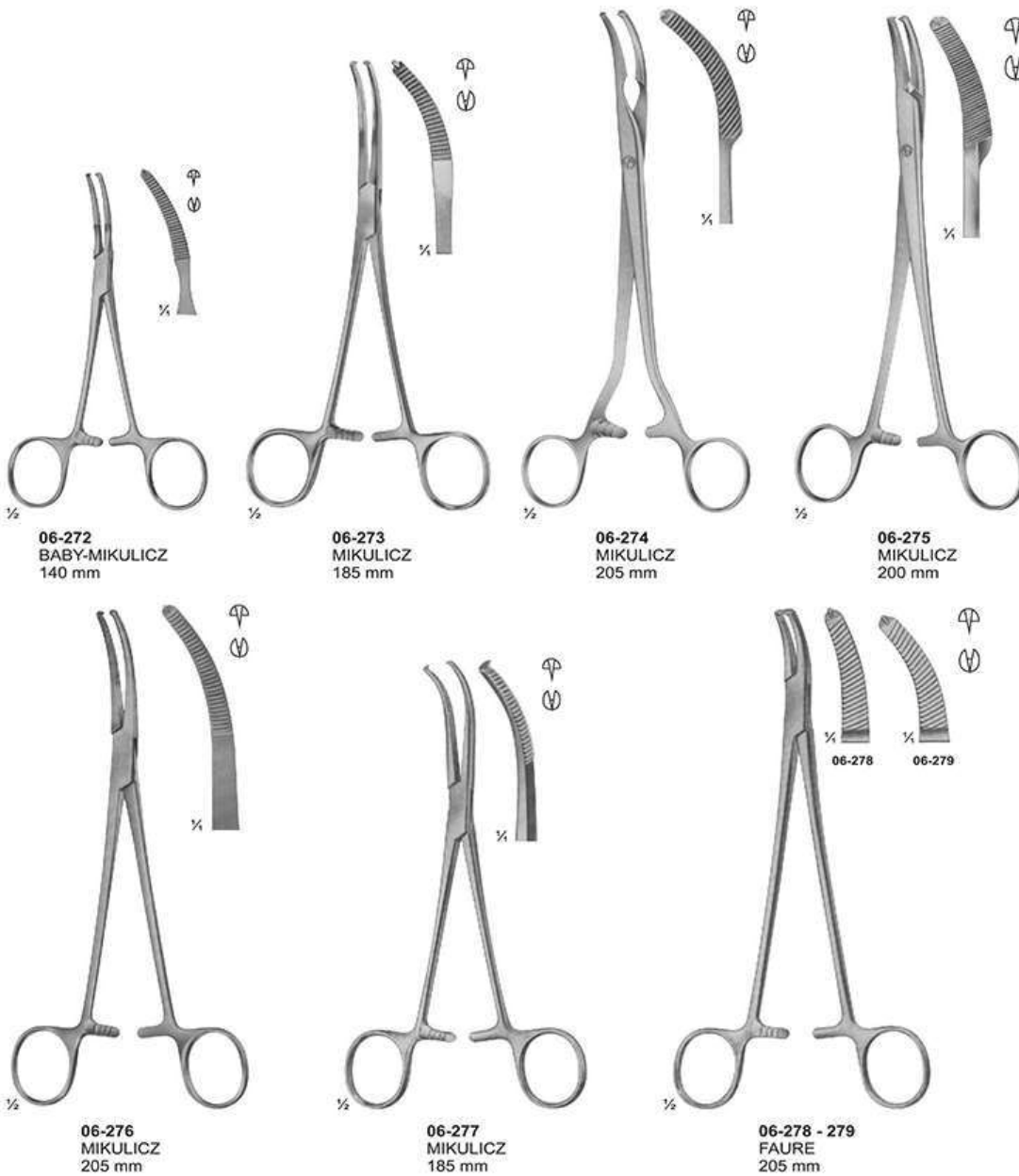

Dissecting- and Ligature Forceps

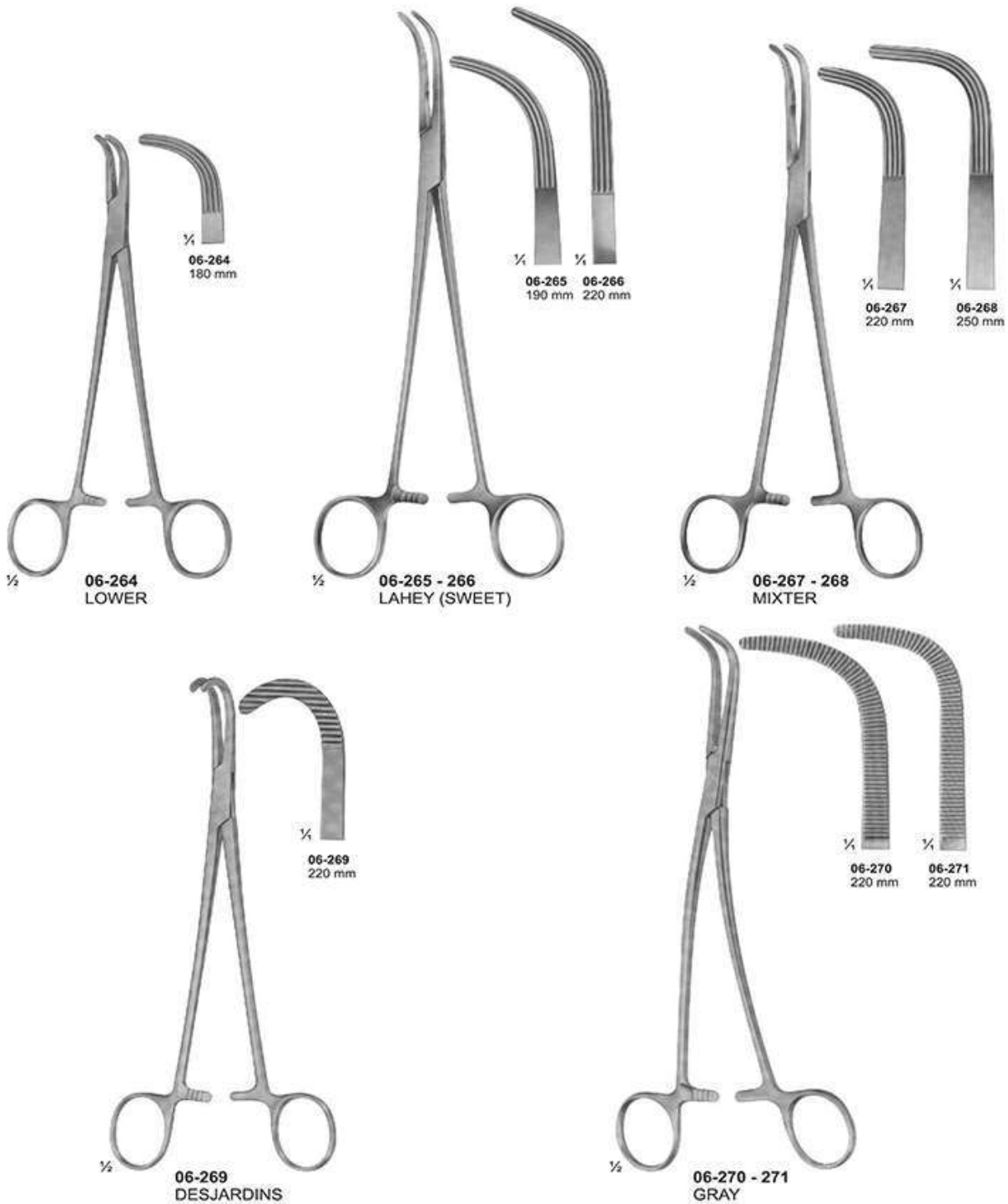

Dissecting- and Ligature Forceps

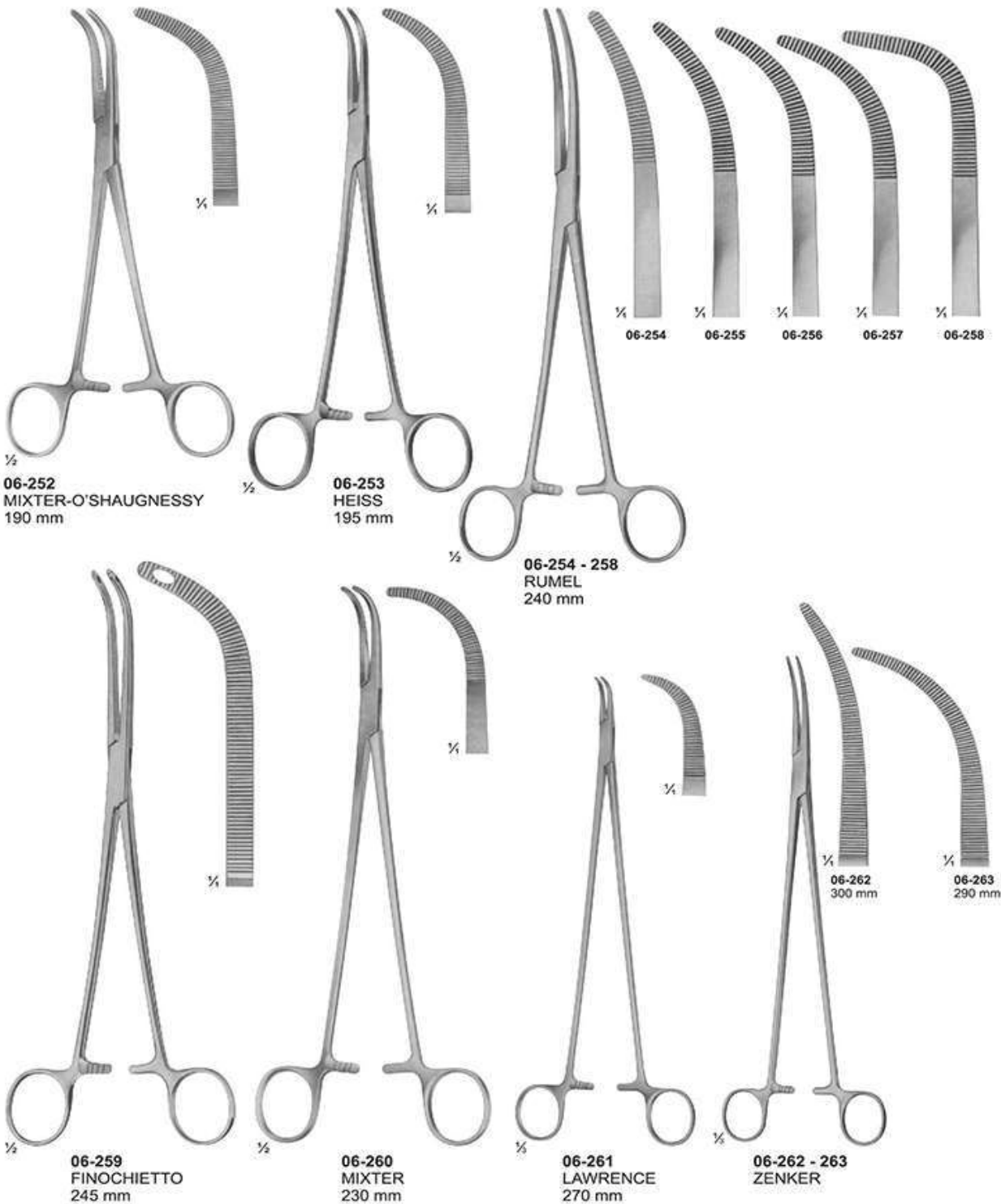

Dissecting- and Ligature Forceps



06-232 - 243
OVERHOLT-GEISSENDOERFER

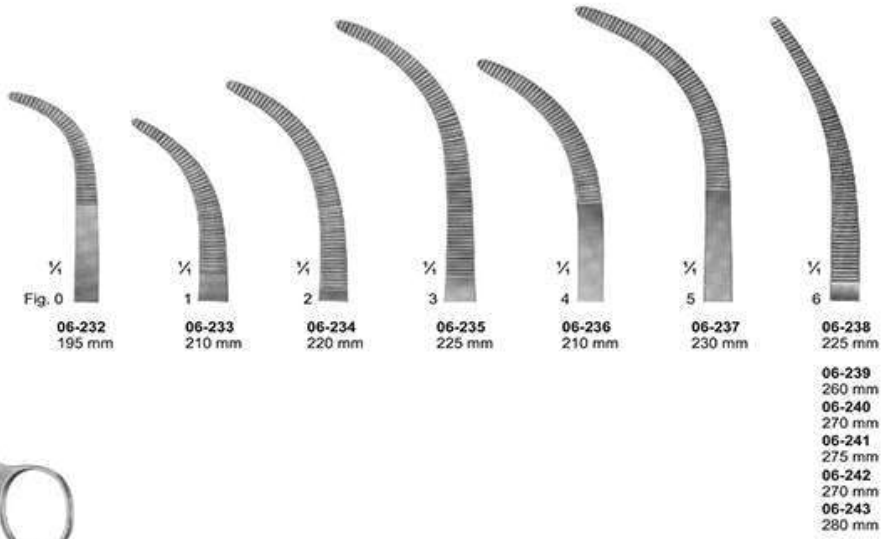

- 06-239 260 mm
- 06-240 270 mm
- 06-241 275 mm
- 06-242 270 mm
- 06-243 280 mm



06-244 - 251
OVERHOLT
fine pattern

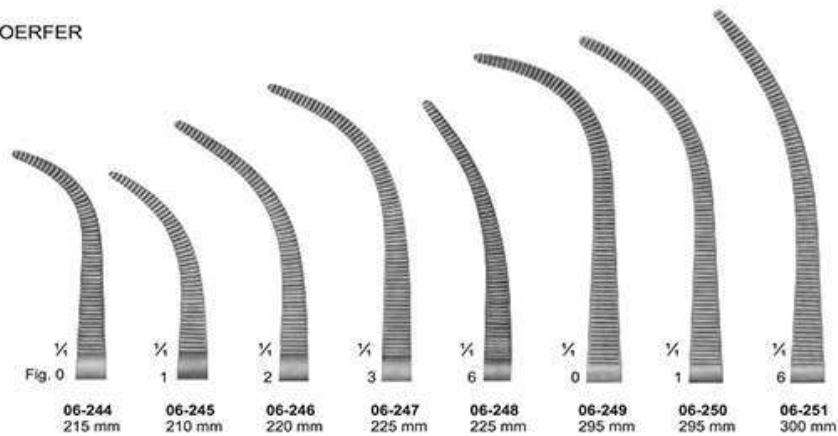

Dissecting- and Ligature Forceps



06-222
MICRO-ADSON
140 mm



06-223
BABY-OVERHOLT
135 mm

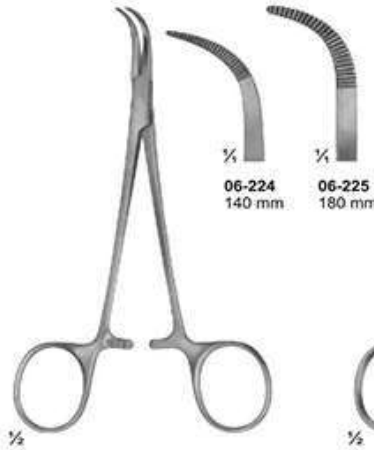

06-224 - 225
BABY-MIXTER

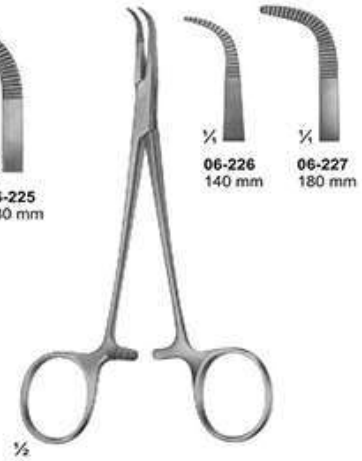

06-226 - 227
BABY-ADSON

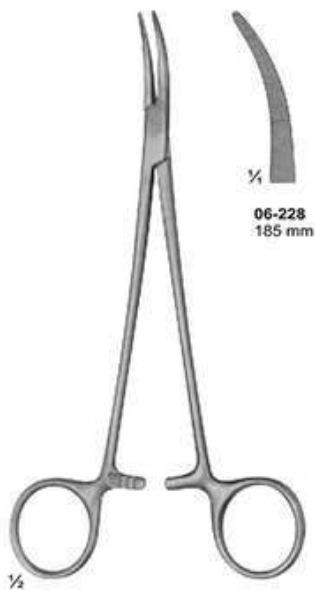

06-228
NISSEN



06-229 - 230
YASARGIL
195 mm



06-231
OVERHOLT-MIXTER

Haemostatic Forceps, Special Pattern, Tonsil Forceps

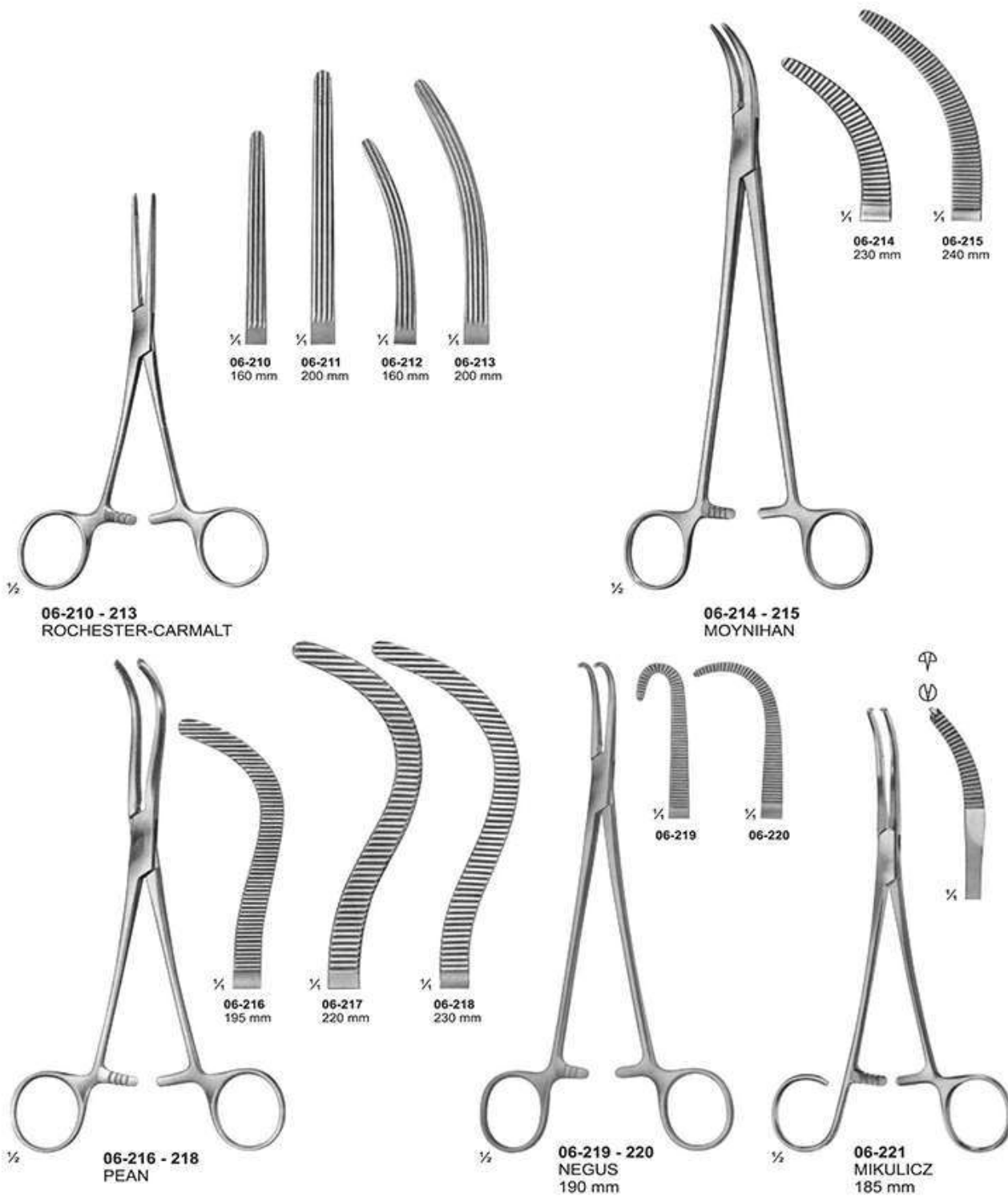

Haemostatic Forceps

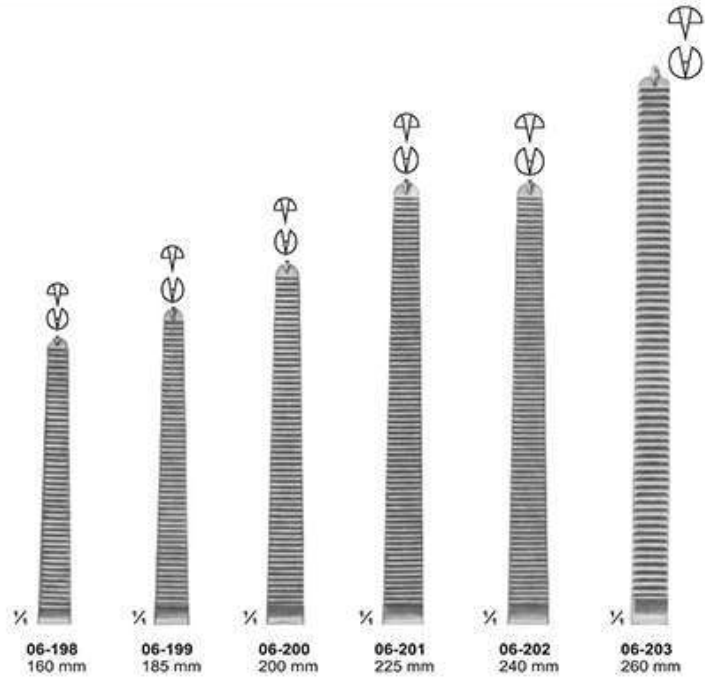

06-198 - 209
KOCHER-OCHSNER

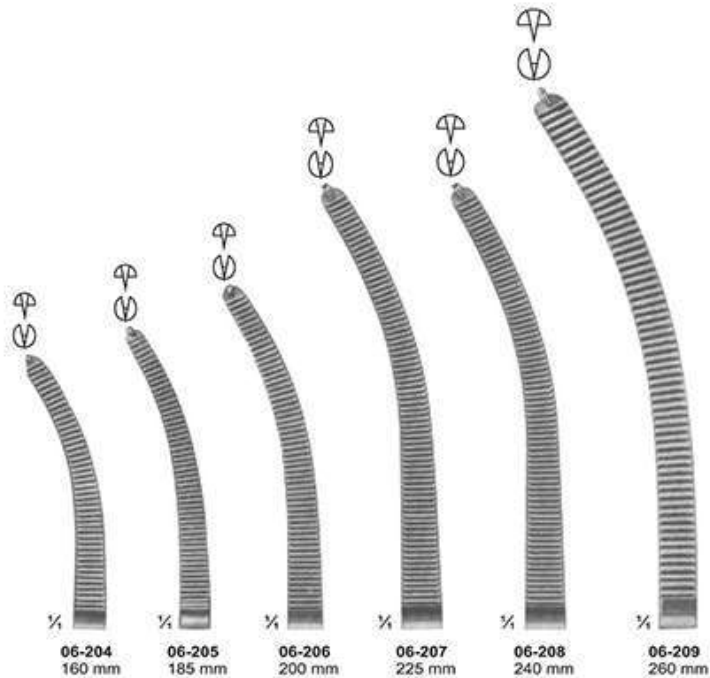

Haemostatic Forceps

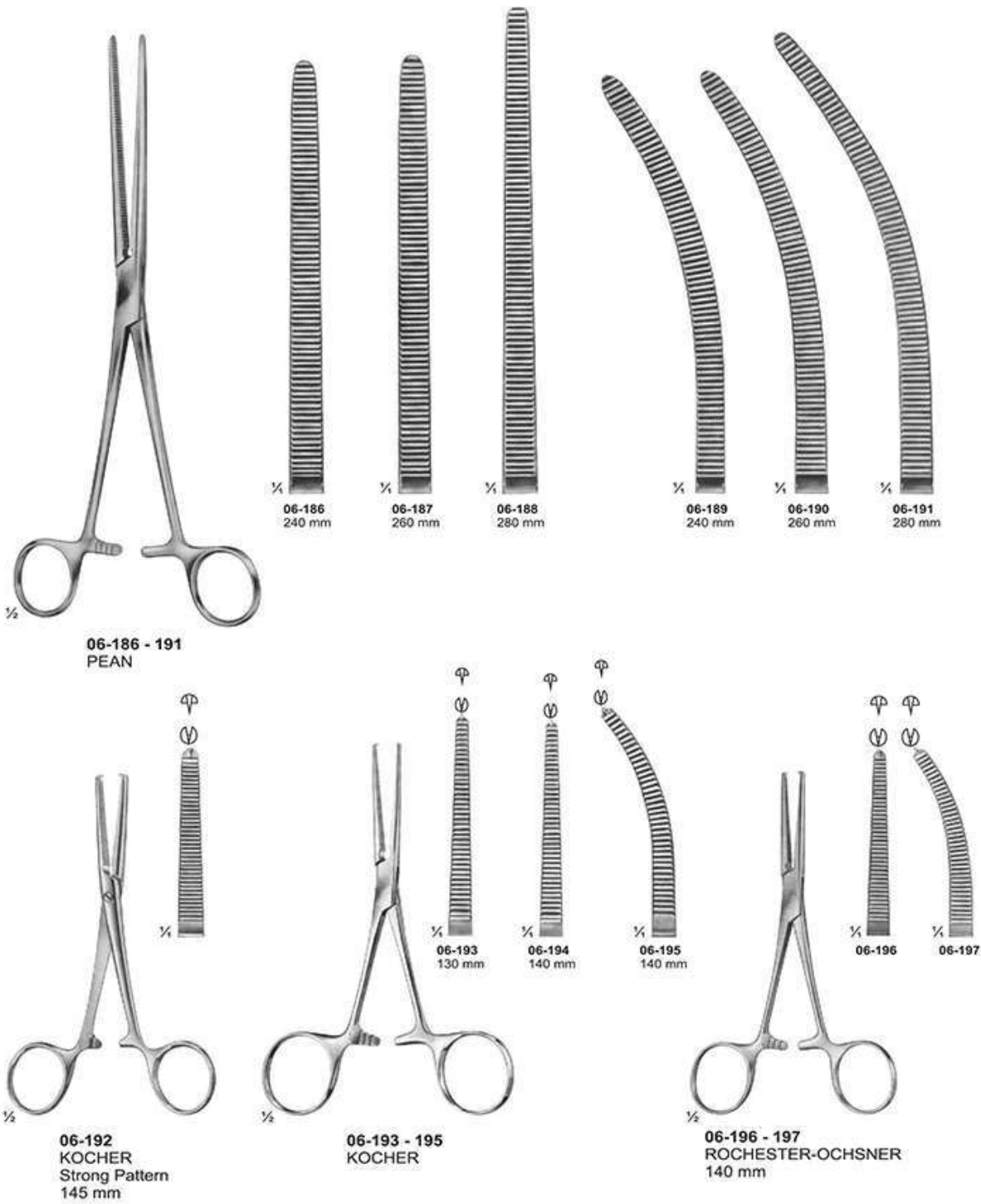

Haemostatic Forceps

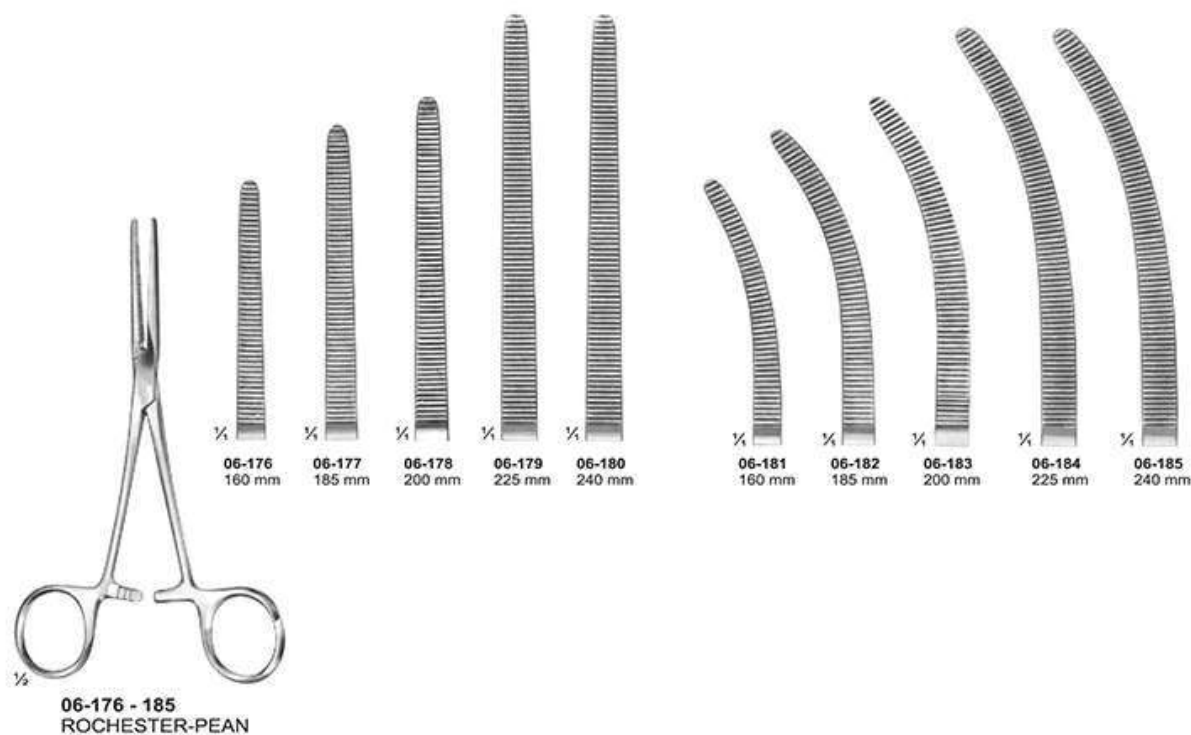

Haemostatic Forceps

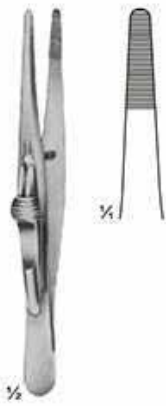

06-156
FRICKE
Artery forceps
130 mm



06-157
KRONLEIN
130 mm

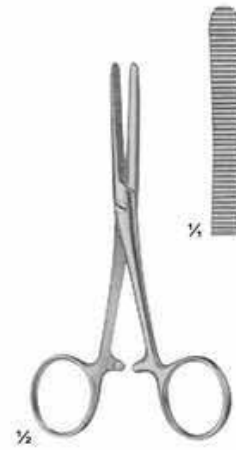

06-158
PEAN
125 mm



06-159 - 160
PEAN



06-159
125 mm



06-160
140 mm



06-161
PEAN

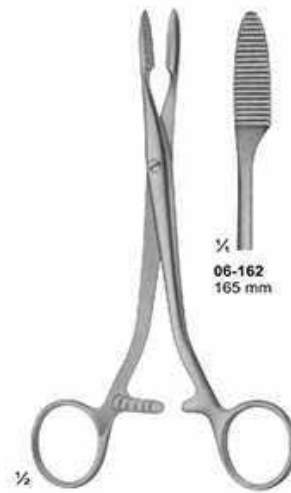

06-162 - 163
PEAN



06-162
165 mm



06-163
185 mm

Delicate Haemostatic Forceps

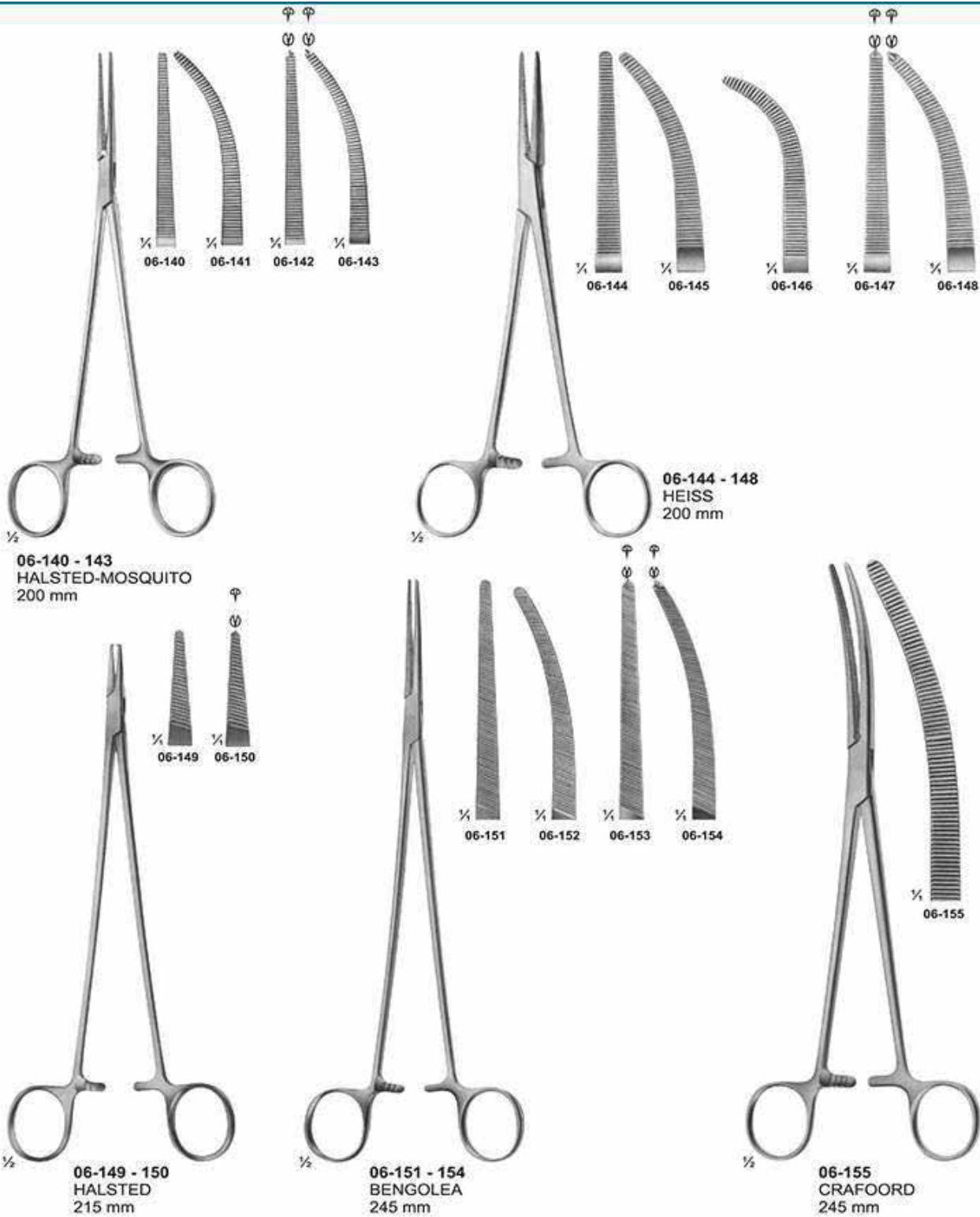

Delicate Haemostatic Forceps

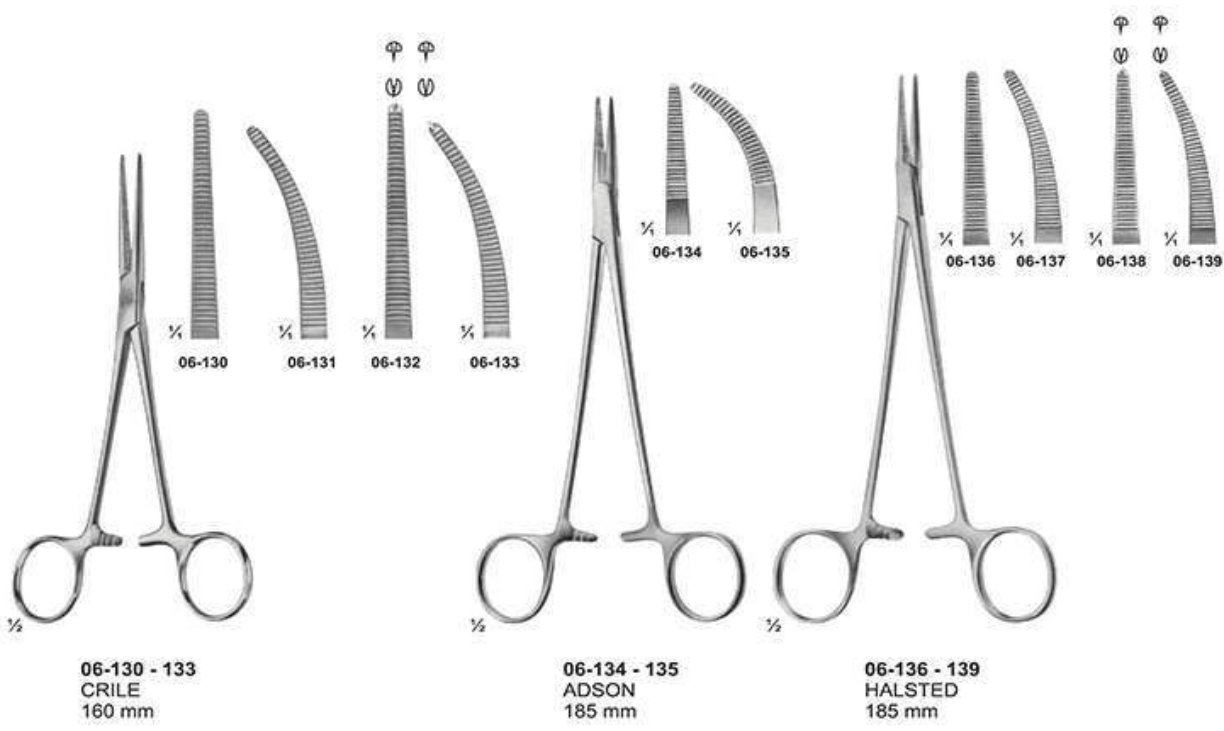
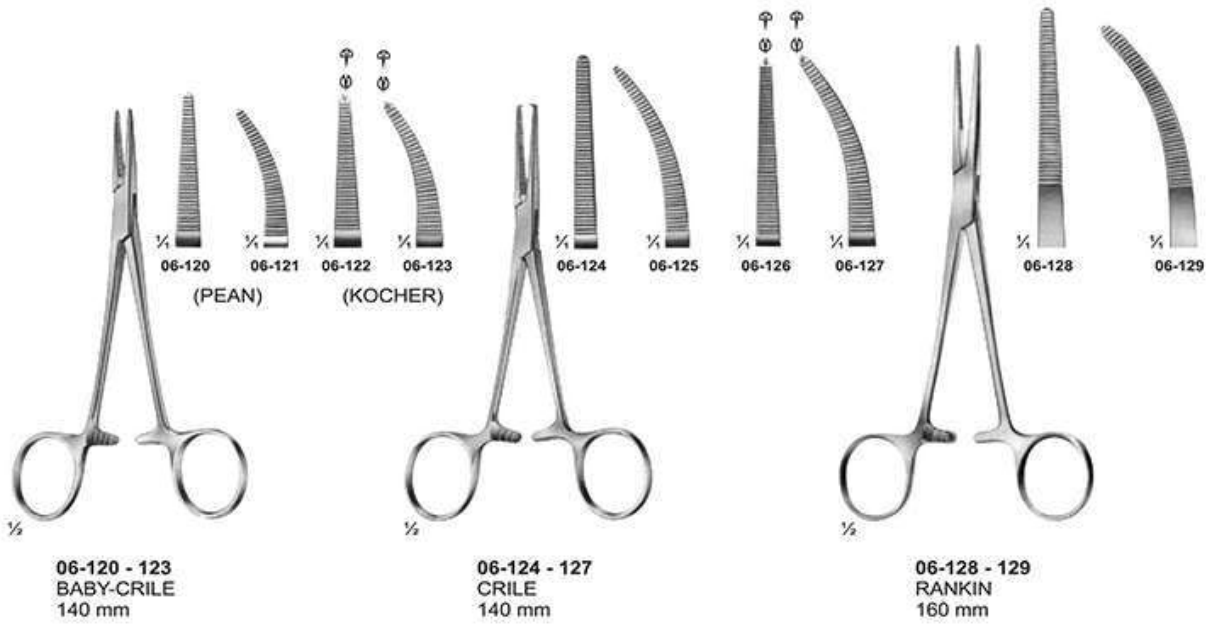

Delicate Haemostatic Forceps

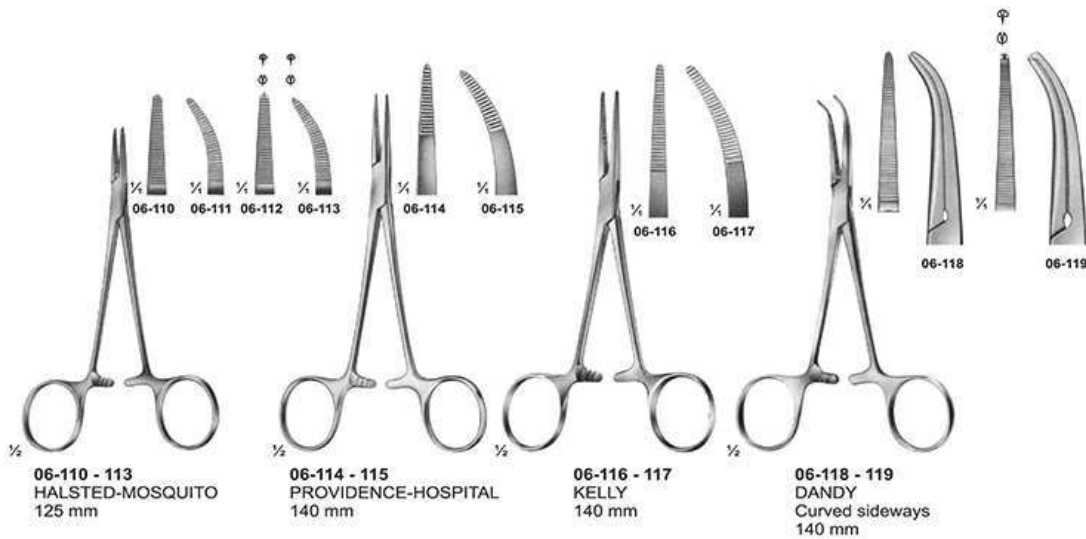
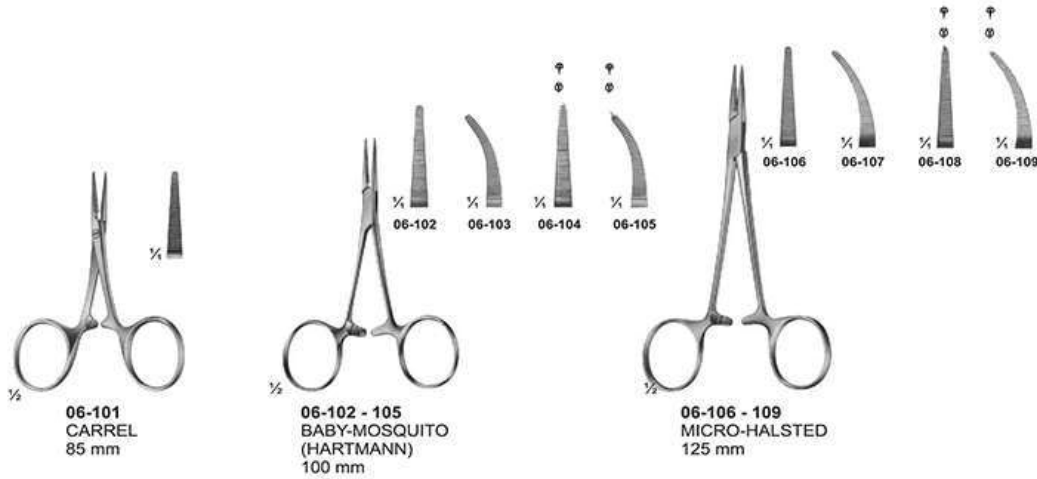

Muller Vessel Clips and Bulldog Clamps

Closing force

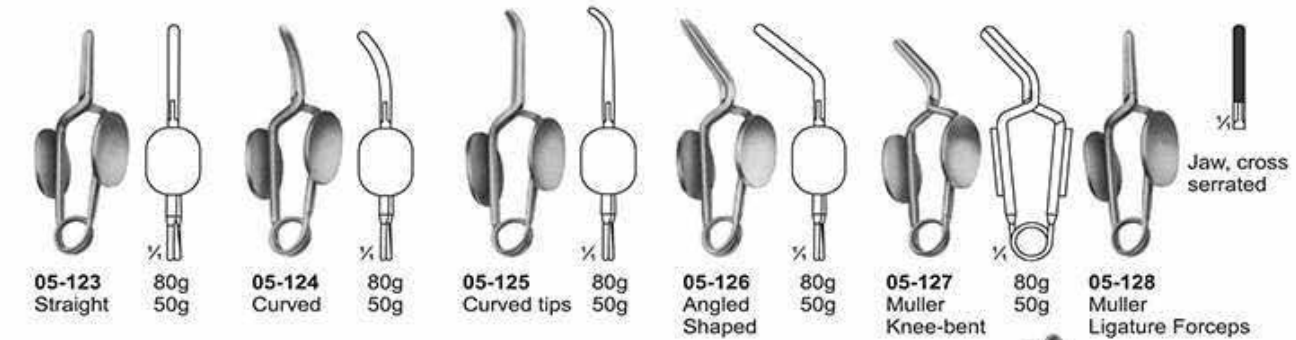

05-123
Straight

80g
50g

05-124
Curved

80g
50g

05-125
Curved tips

80g
50g

05-126
Angled
Shaped

80g
50g

05-127
Muller
Knee-bent

80g
50g

05-128
Muller
Ligature Forceps

Jaw, cross
serrated

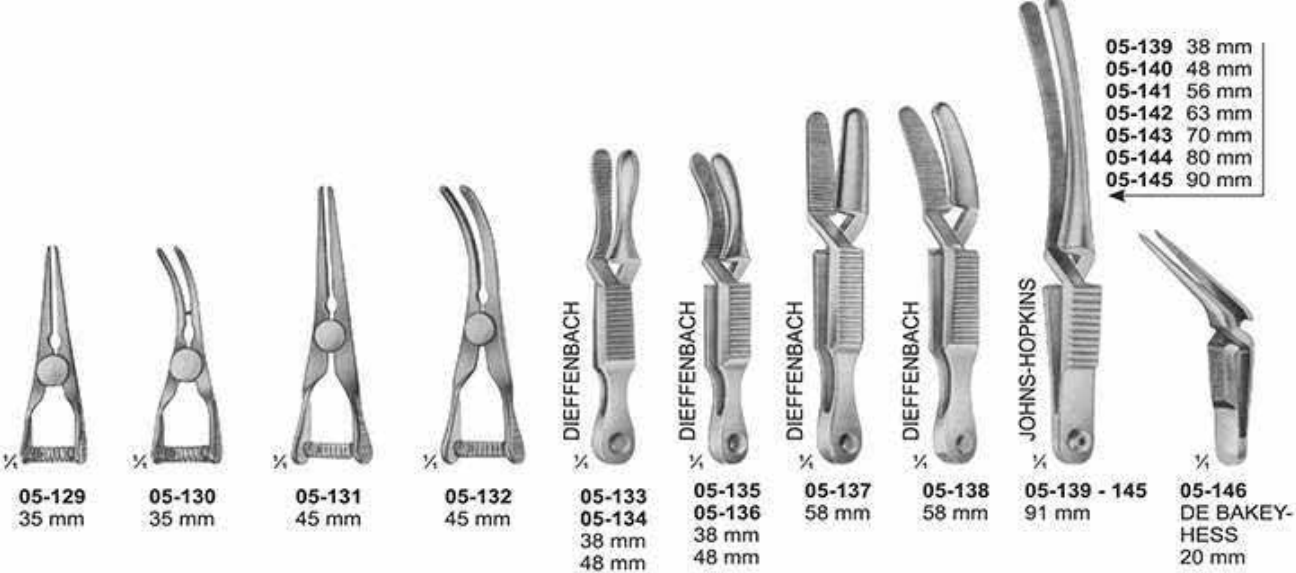

- 05-139 38 mm
- 05-140 48 mm
- 05-141 56 mm
- 05-142 63 mm
- 05-143 70 mm
- 05-144 80 mm
- 05-145 90 mm

05-129
35 mm

05-130
35 mm

05-131
45 mm

05-132
45 mm

05-133
38 mm

05-134
48 mm

05-135
38 mm

05-136
48 mm

05-137
58 mm

05-138
58 mm

05-139 - 145
91 mm

05-146
DE BAKEY-
HESS
20 mm

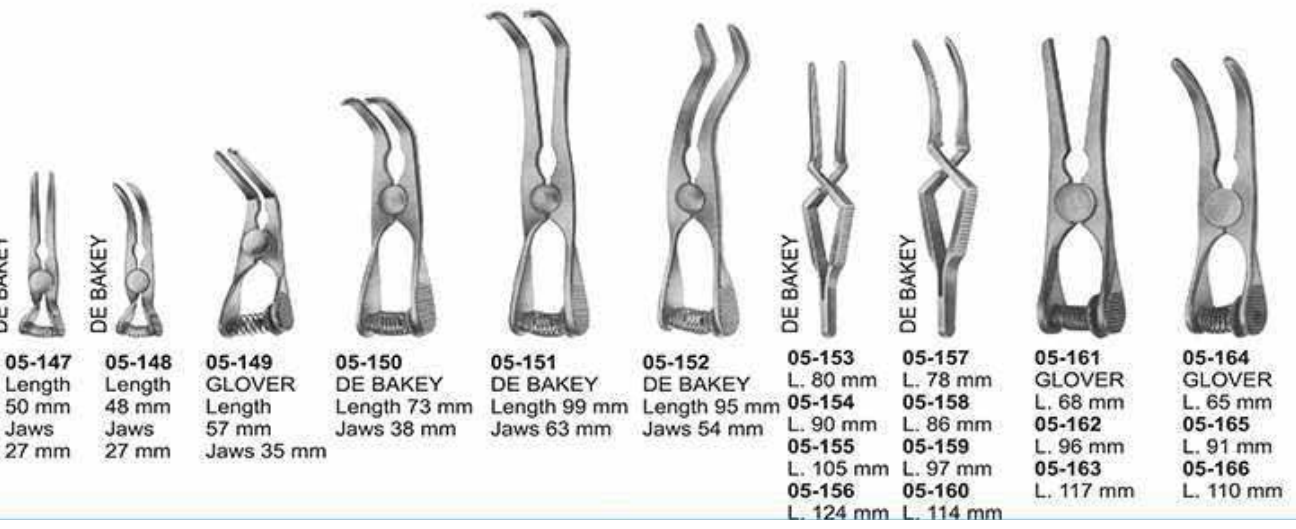

05-147
Length
50 mm
Jaws
27 mm

05-148
Length
48 mm
Jaws
27 mm

05-149
GLOVER
Length
57 mm
Jaws
35 mm

05-150
DE BAKEY
Length 73 mm
Jaws 38 mm

05-151
DE BAKEY
Length 99 mm
Jaws 63 mm

05-152
DE BAKEY
Length 95 mm
Jaws 54 mm

05-153
L. 80 mm

05-154
L. 90 mm

05-155
L. 105 mm

05-156
L. 124 mm

05-157
L. 78 mm

05-158
L. 86 mm

05-159
L. 105 mm

05-160
L. 114 mm

05-161
GLOVER
L. 68 mm

05-162
L. 96 mm

05-163
L. 117 mm

05-164
GLOVER
L. 65 mm

05-165
L. 91 mm

05-166
L. 110 mm

Towel Clamps



05-117
ROBIN
with holders for tubing
up to 13 mm
135 mm



05-118
with clip for tubing
up to 15 mm
110 mm

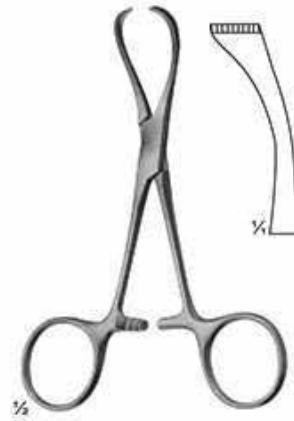

05-119
LORNA
non perforating
130 mm



05-120
for paper cloths
140 mm



05-121
BUNT
105 mm



05-122
MAYO
140 mm

Towel Clamps



05-101
JONES
85 mm



05-102
ENGL. MOD.
85 mm

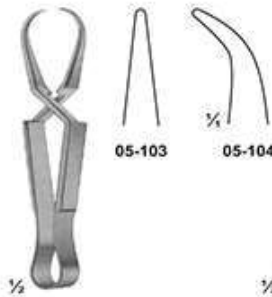

05-103 - 104
SCHAEDEL
85 mm

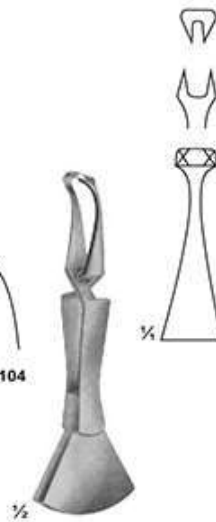

05-105
DOYEN
110 mm



05-106
DOYEN
180 mm

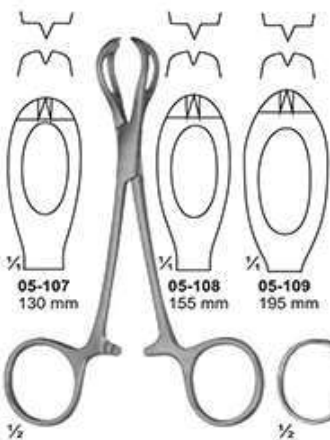

05-107 - 109
LANE

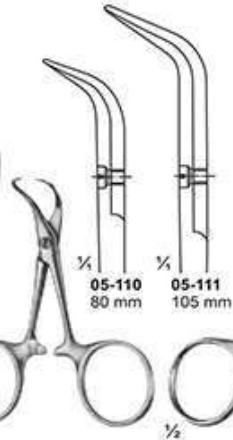

05-110 - 111
BACKHAUS

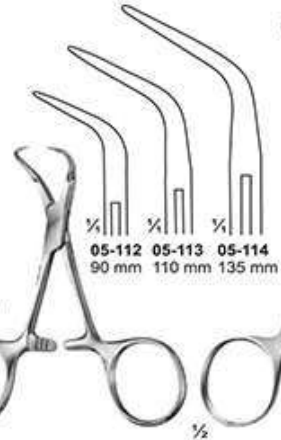

05-112 - 114
BACKHAUS

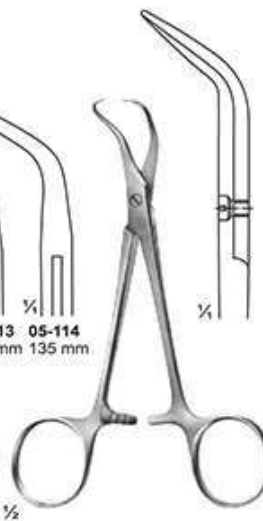

05-115
BACKHAUS-KOCHER
135 mm

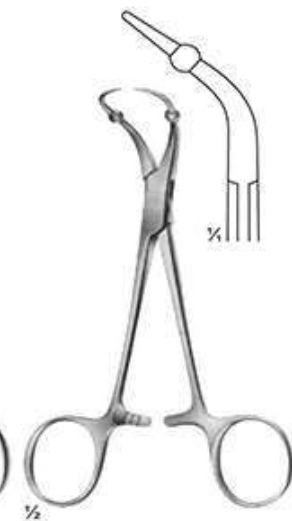

05-116
ROEDER
135 mm

Organ -and Tissue Grasping Forceps

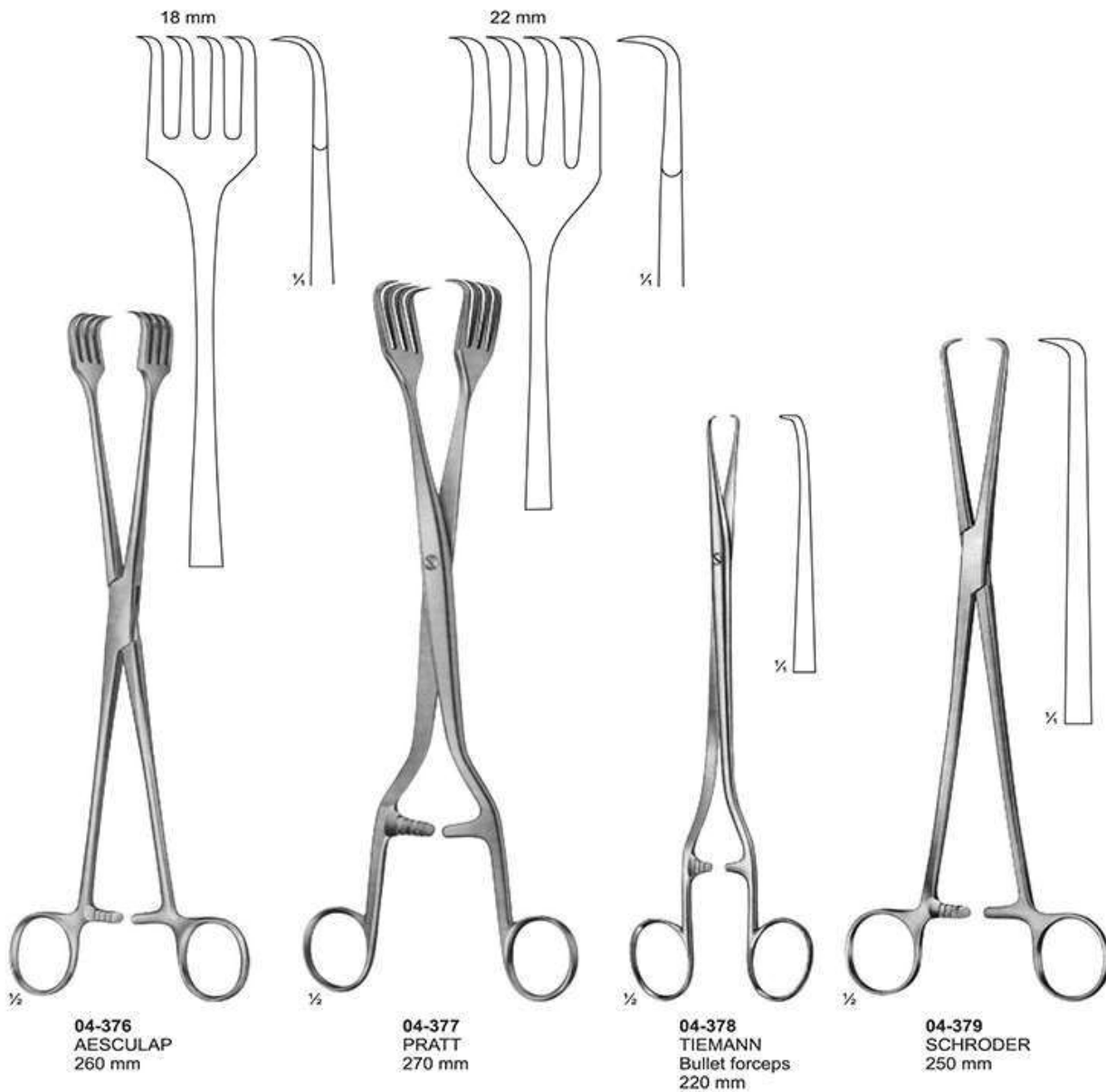

Artery Traction - and Tissue Grasping Forceps



04-368
CHAPUT
2 x 3 teeth
125 mm

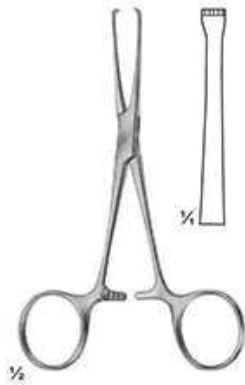

04-369
BABY-ALLIS
4 x 5 teeth
130 mm

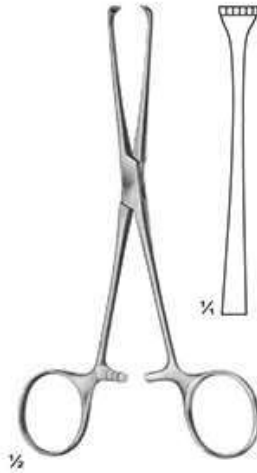

04-370
BOYS-ALLIS
5 x 6 teeth
155 mm

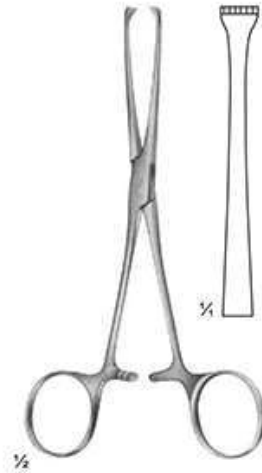

04-371
ALLIS
5 x 6 teeth
155 mm



04-372
LAHEY
135 mm

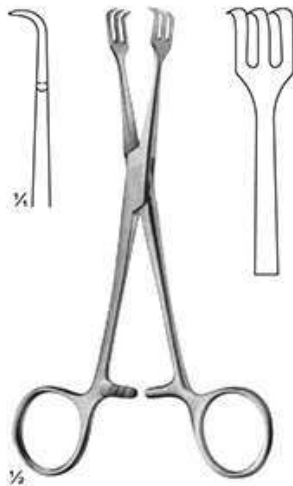

04-373
LAHEY
135 mm

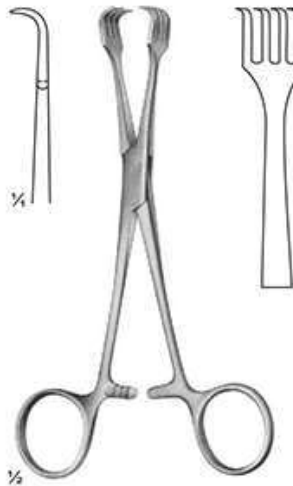

04-374
BRAUN
155 mm

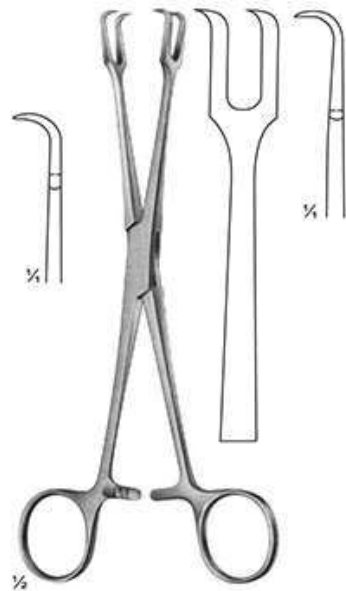

04-375
MUSEUX
200 mm

Tendon Seizing Forceps

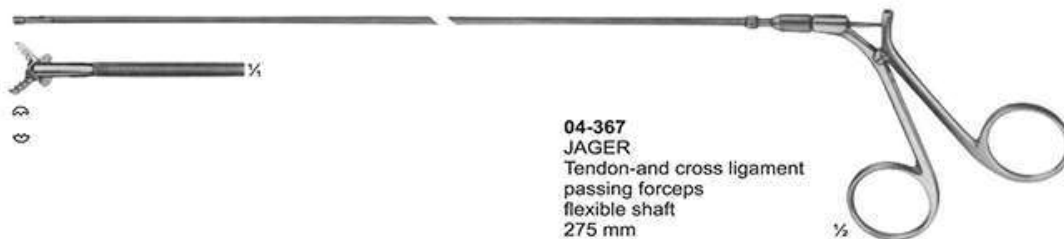
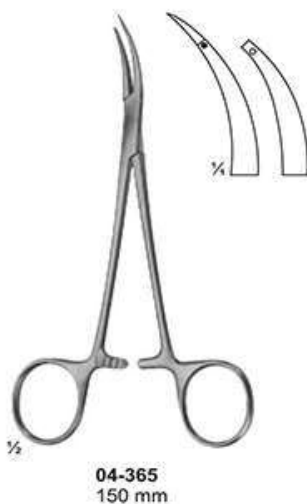
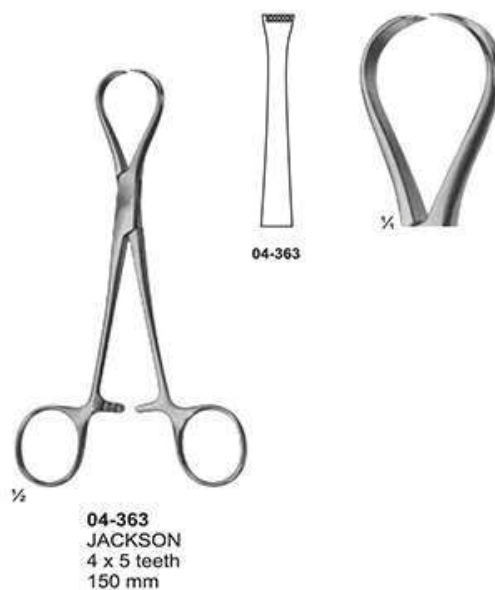
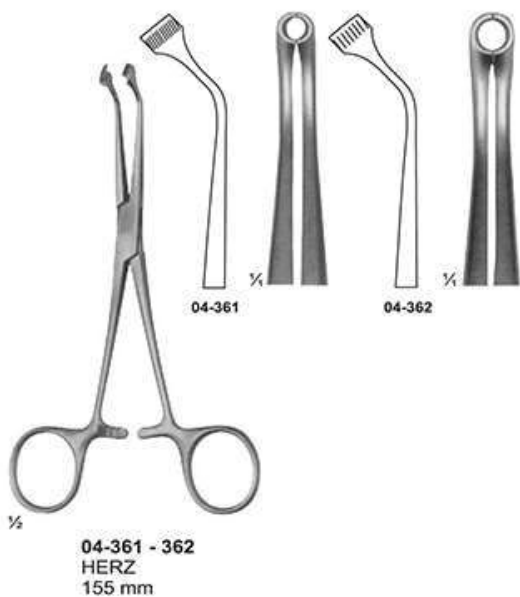

Dressing, Sponge holding, Organ and Tissue Grasping Forceps

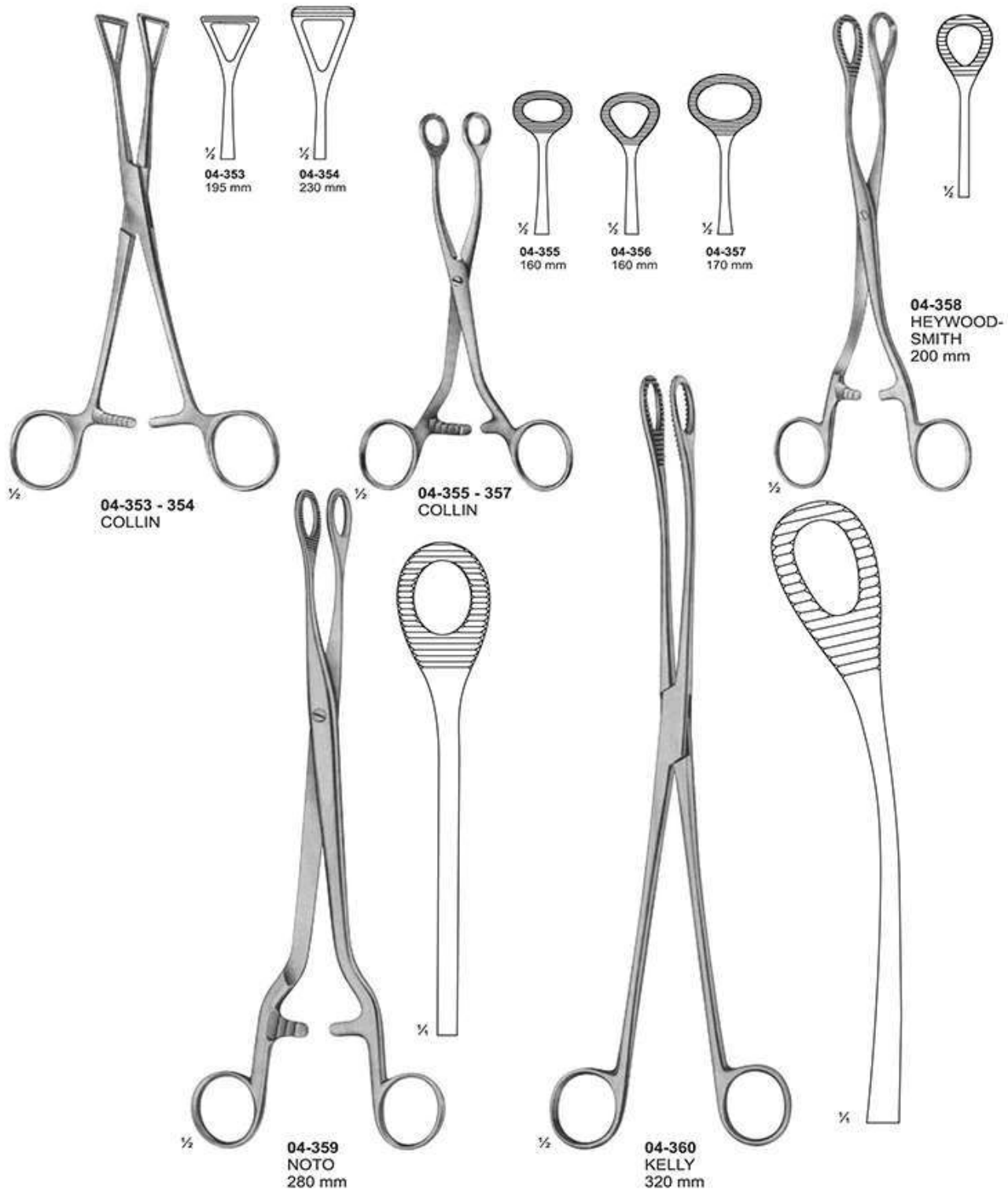

Dressing, Sponge holding, Organ and Tissue Grasping Forceps

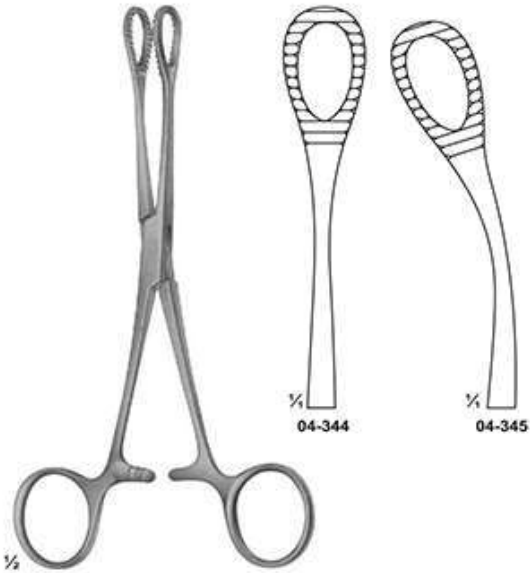

04-344 - 345
FOERSTER-BALLENGER
180 mm

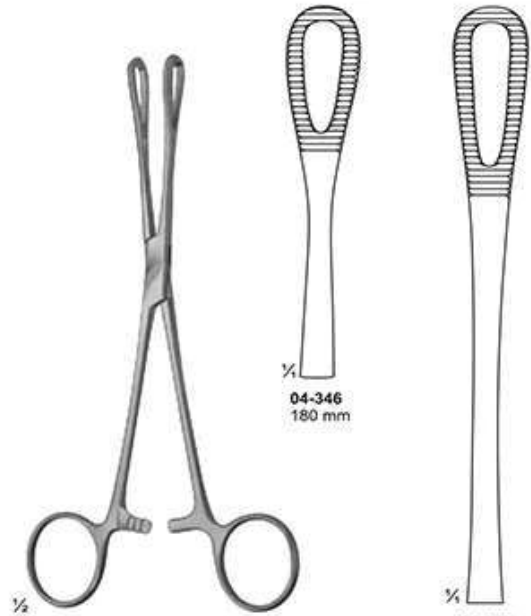

04-346 - 347
RAMPLEY

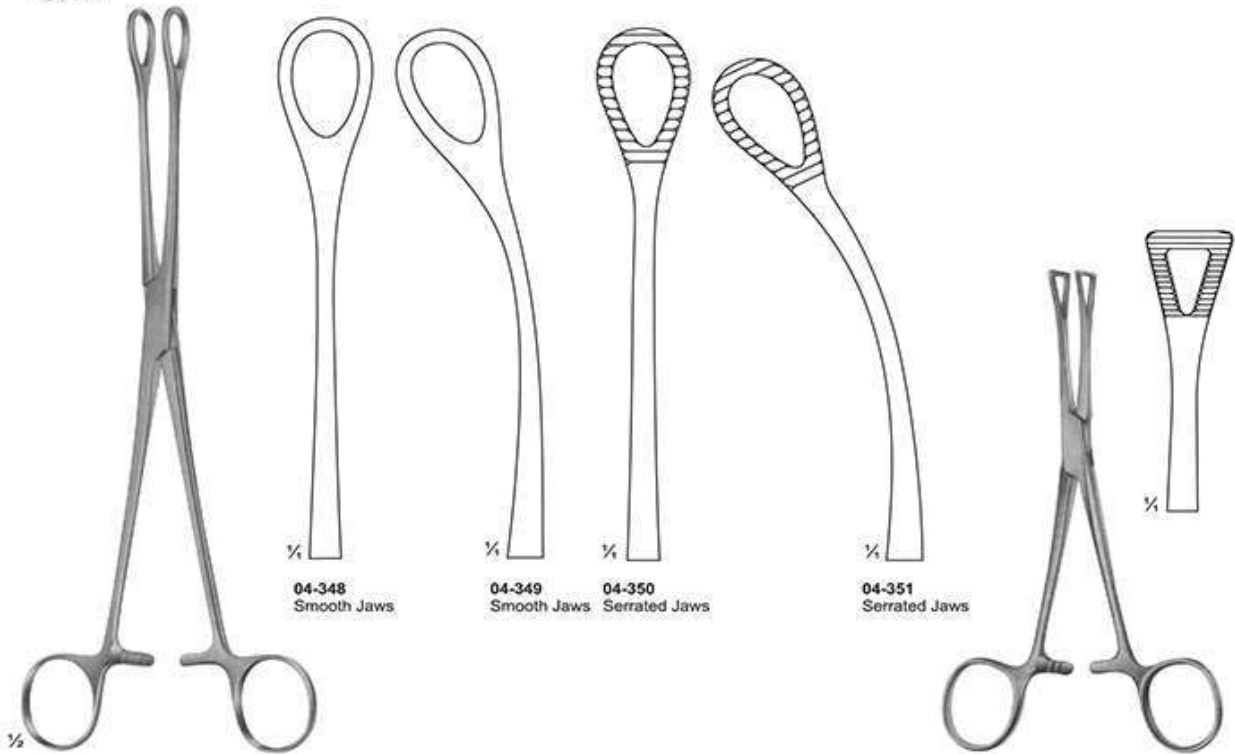

04-348 - 351
FOERSTER-BALLENGER
240 mm

04-352
PENNINGTON
155 mm

Sponge and Dressing Forceps

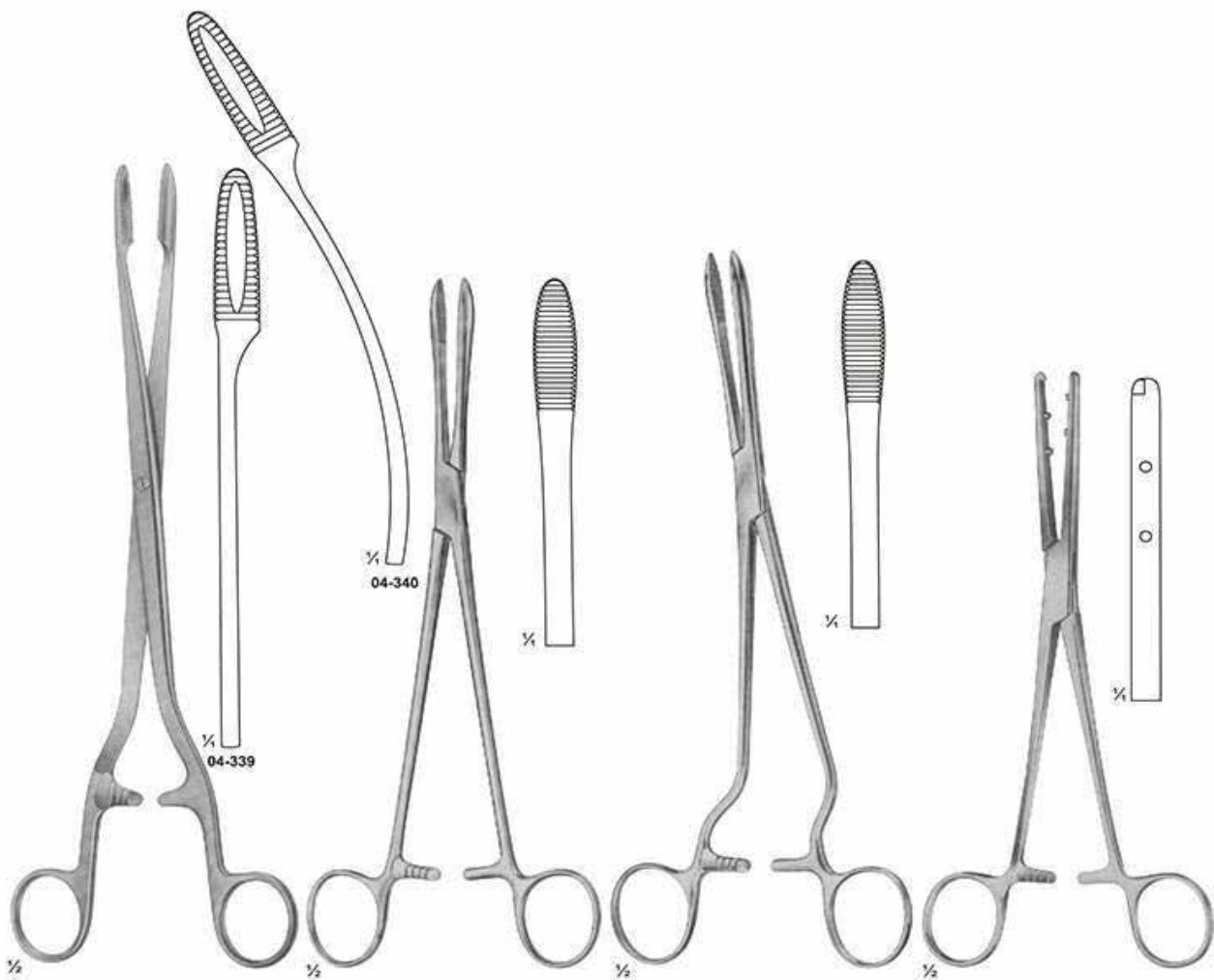

04-339 - 340
SIMS-MAIER
280 mm

04-341
COLLIN
240 mm

04-342
CHERON
Handles Laterally Angled
240 mm

04-343
EMMET
210 mm

Sponge and Dressing Forceps

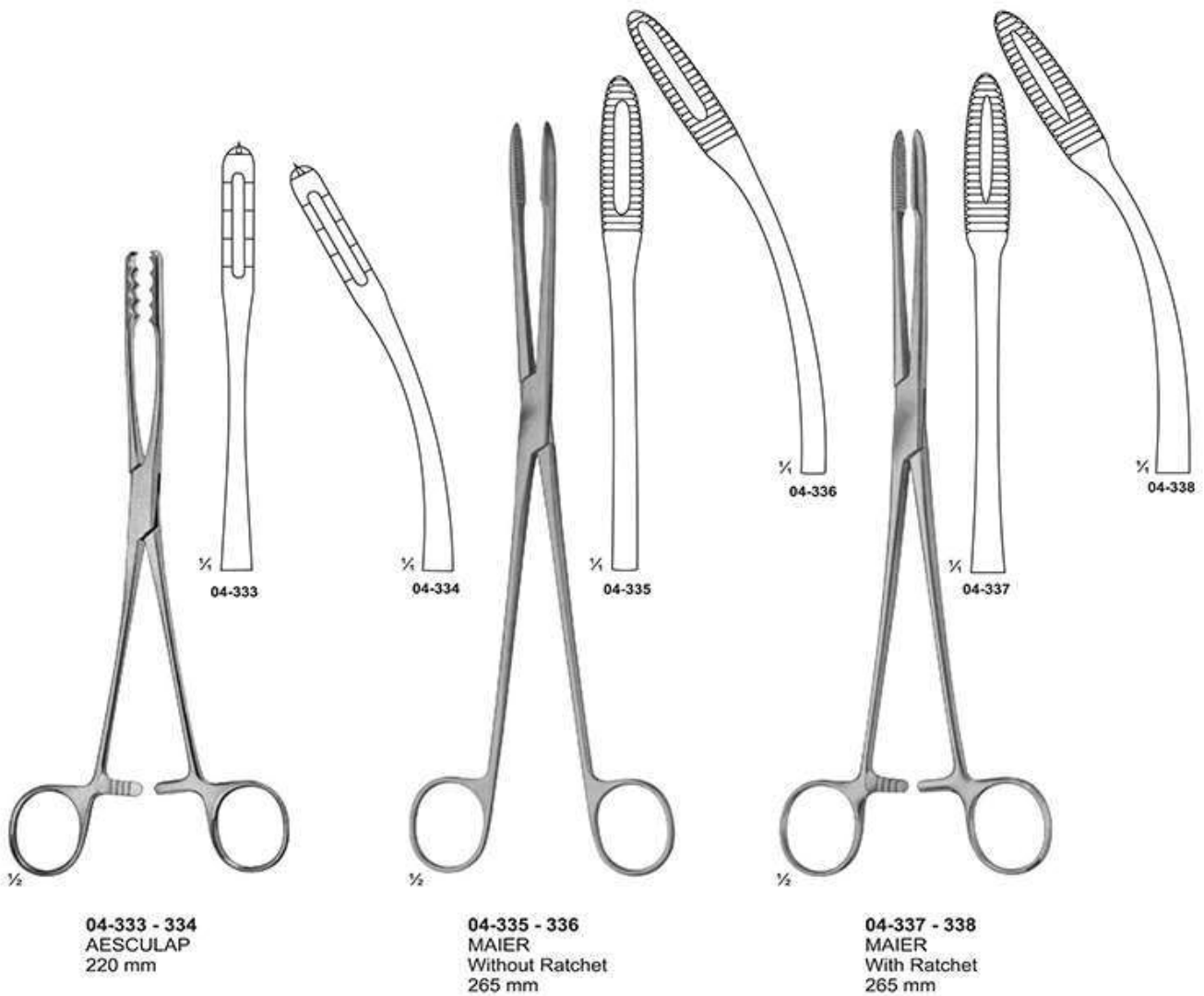

Sponge and Dressing Forceps

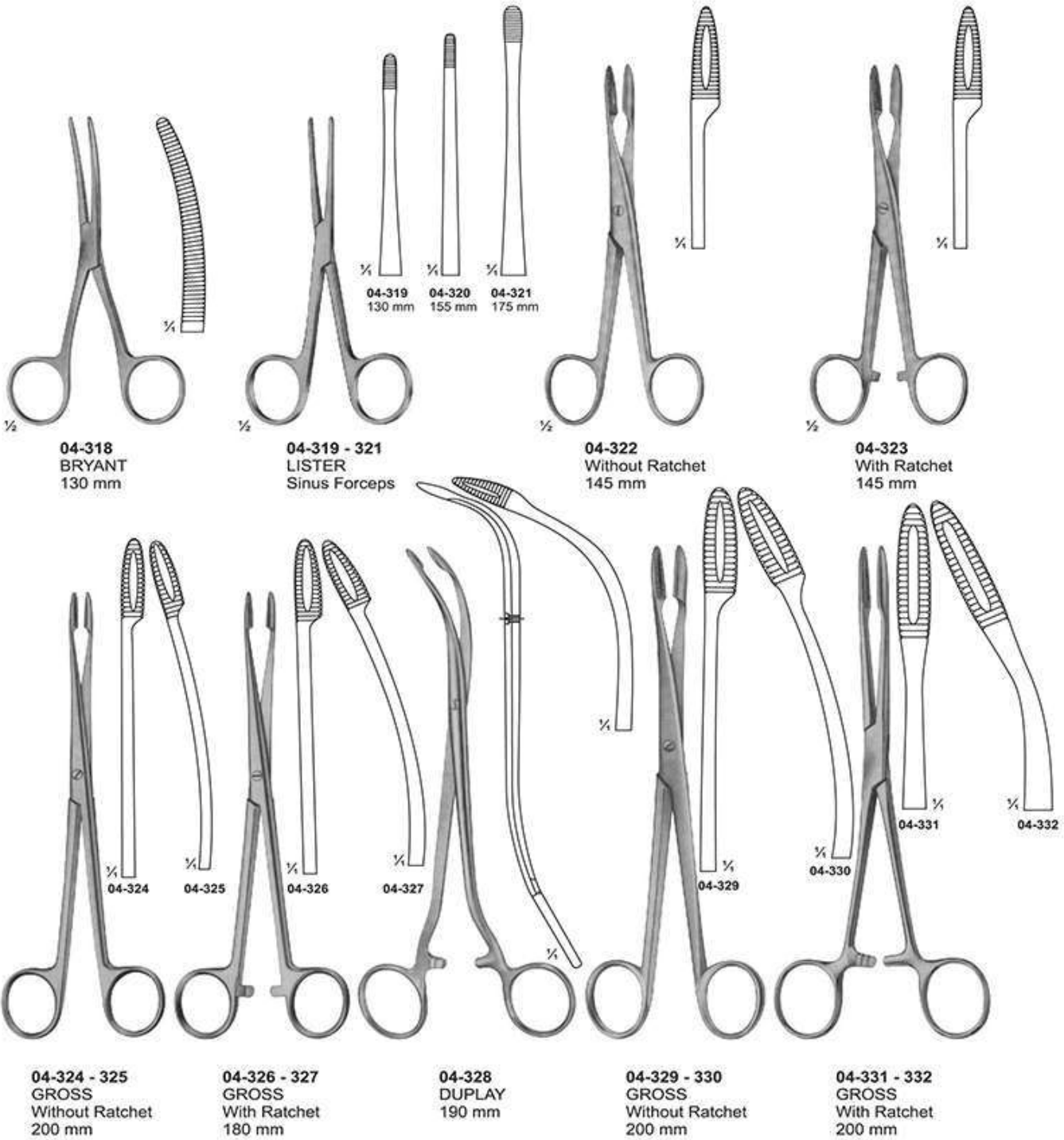

Splinter and Cila Forceps

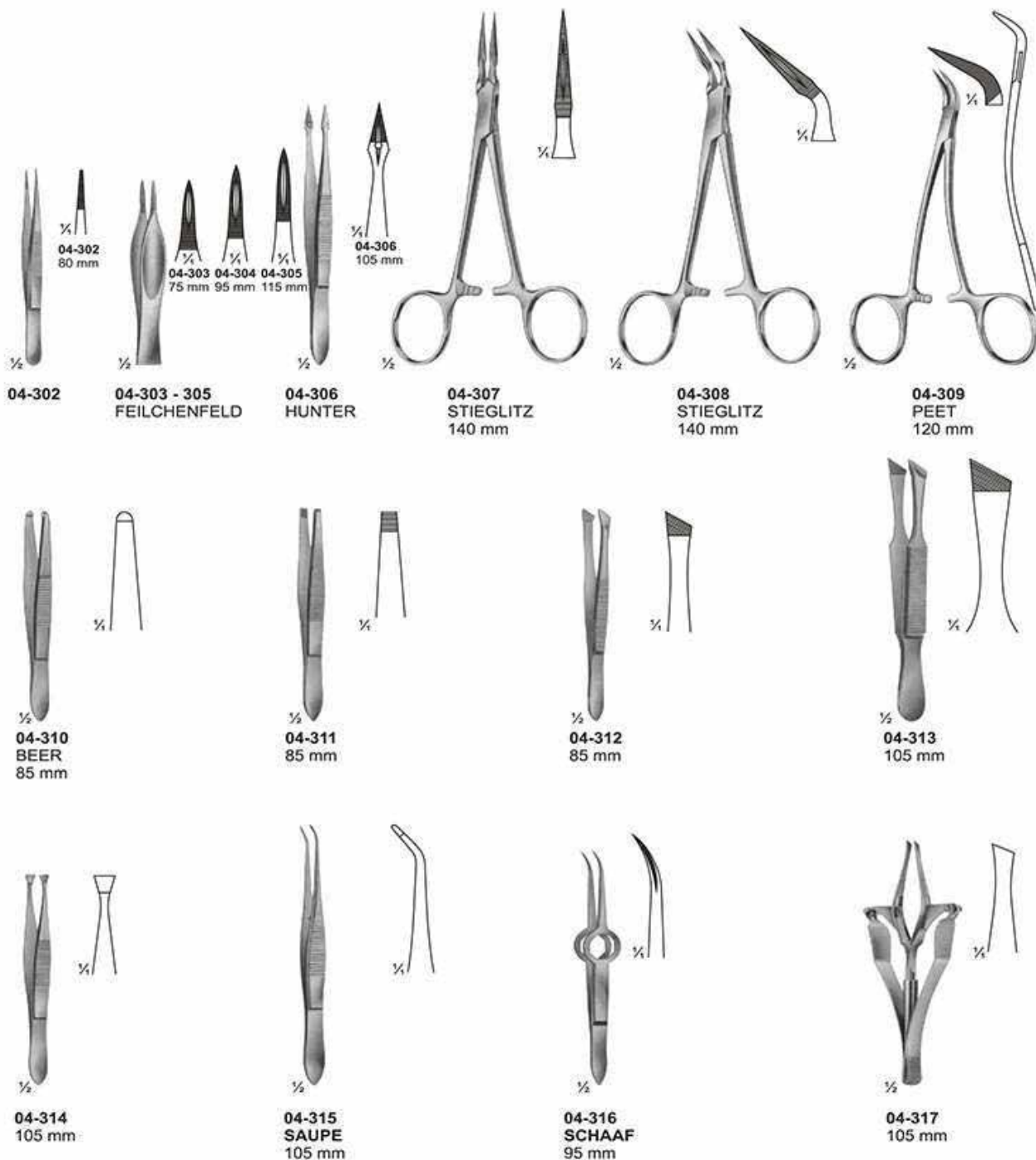

Tissue Forceps, Lungs Dissecting Forceps

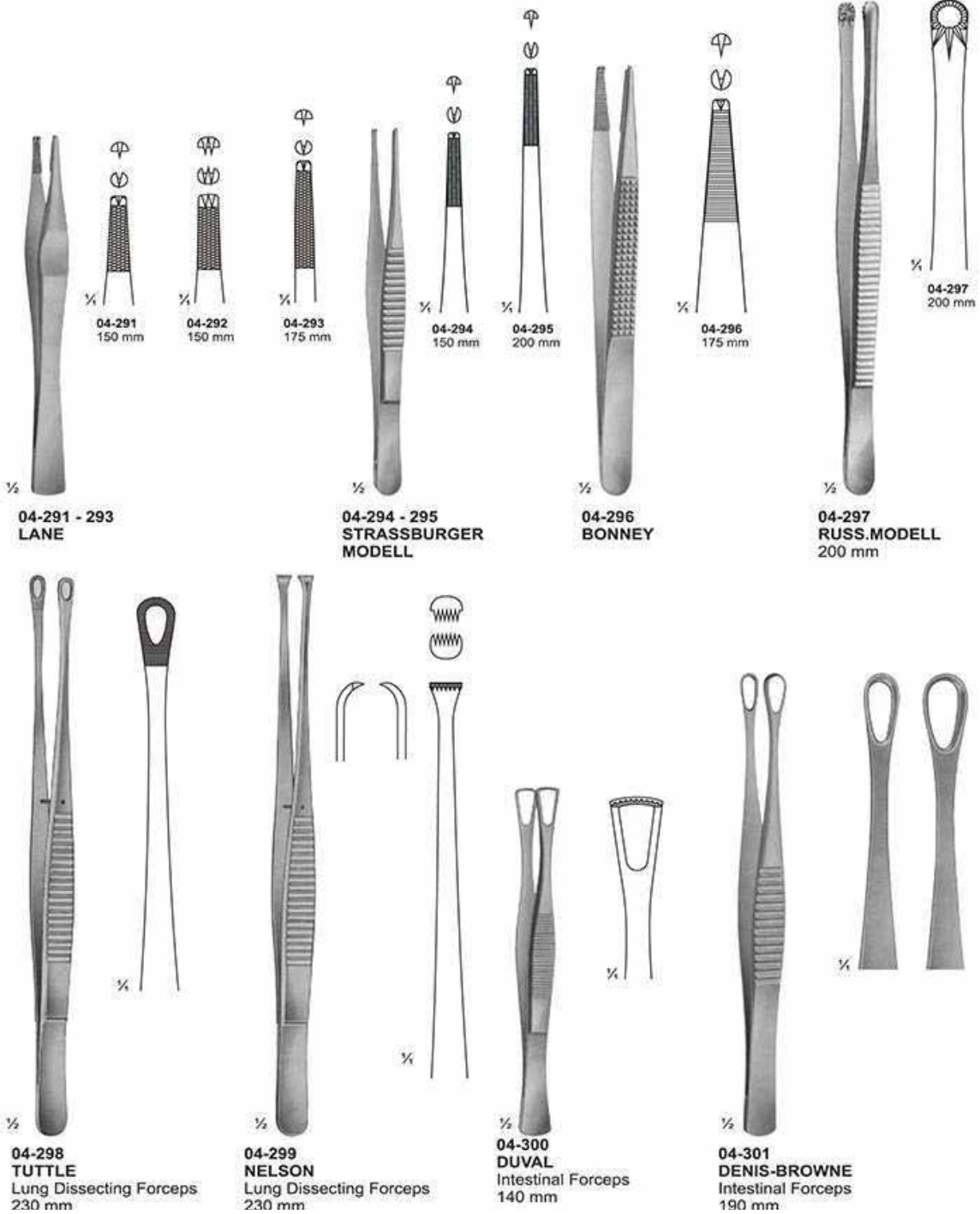

Tissue Forceps

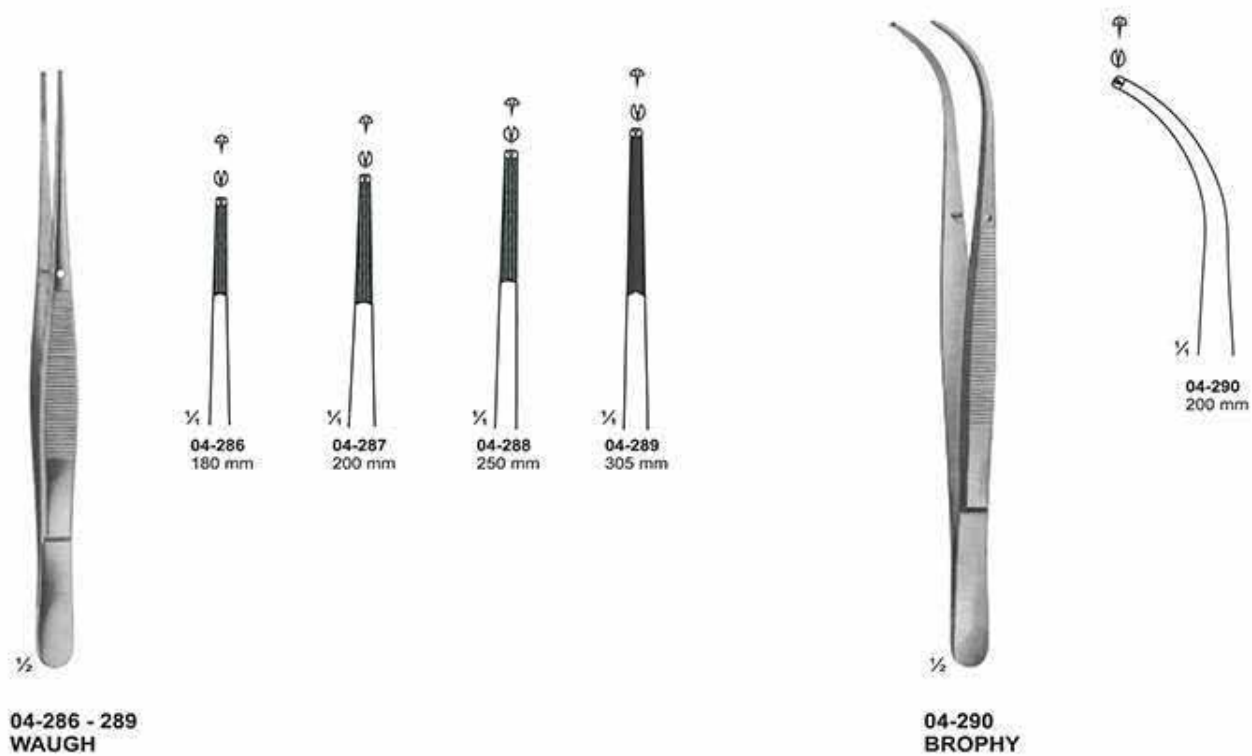
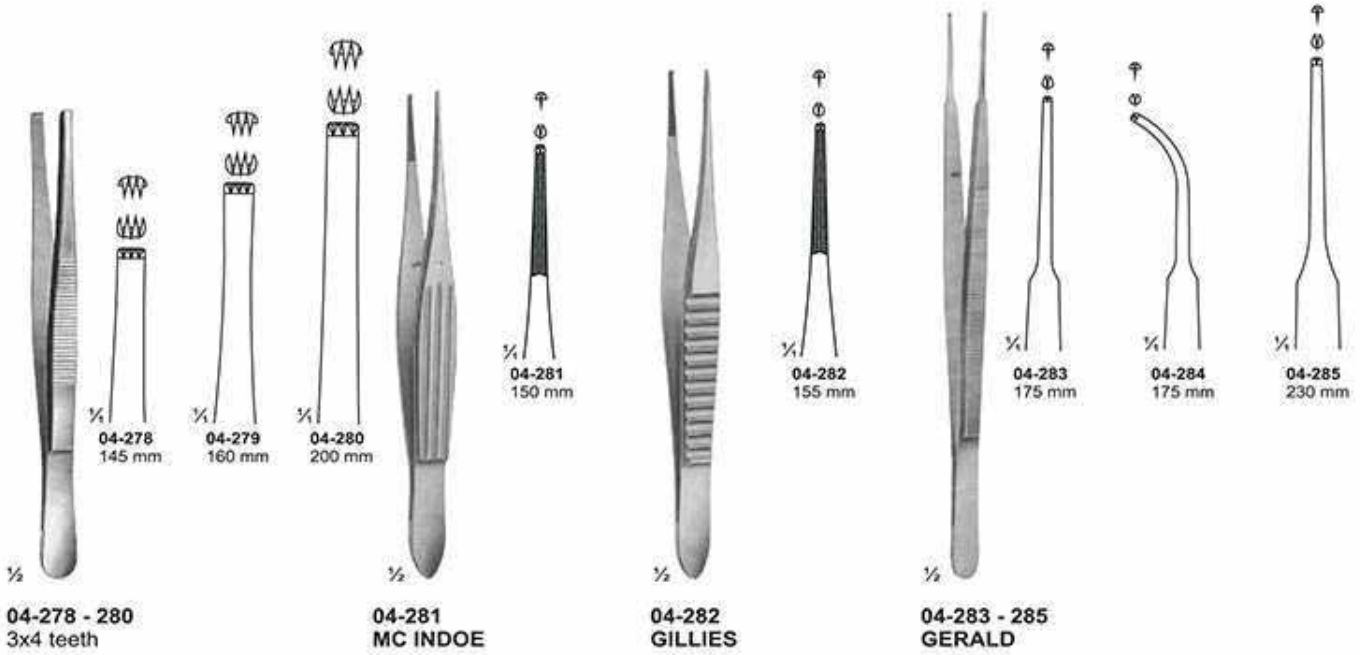

Tissue Forceps

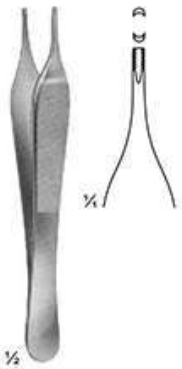

04-260
ADSON - BROWN
Non-traumatic
120 mm

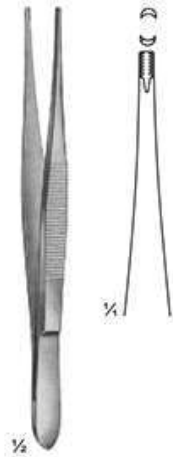

04-261
BROWN
120 mm

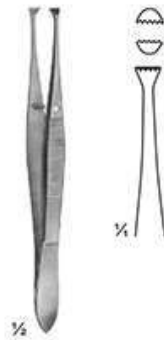

04-262
GRAEFE
110 mm

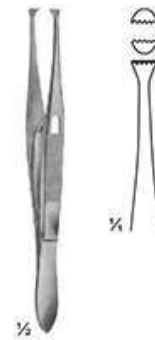

04-263
GRAEFE
With Catch
110 mm

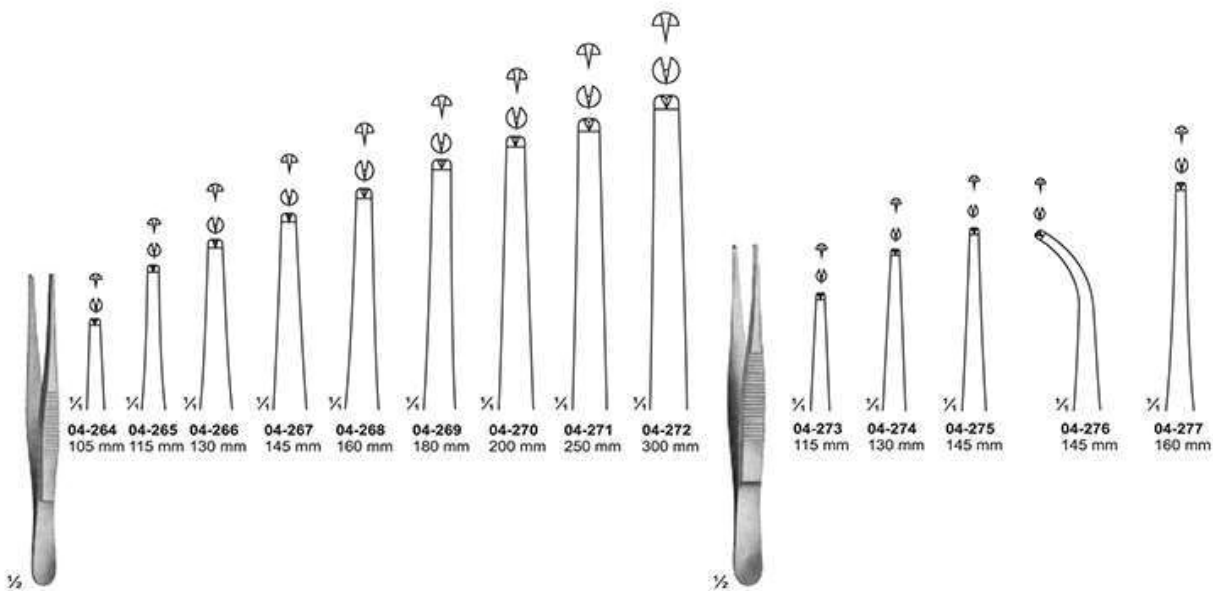

04-264 - 272
STANDARD

04-273 - 277
GRAEFE
110 mm

Forceps, Bayonet - Shaped

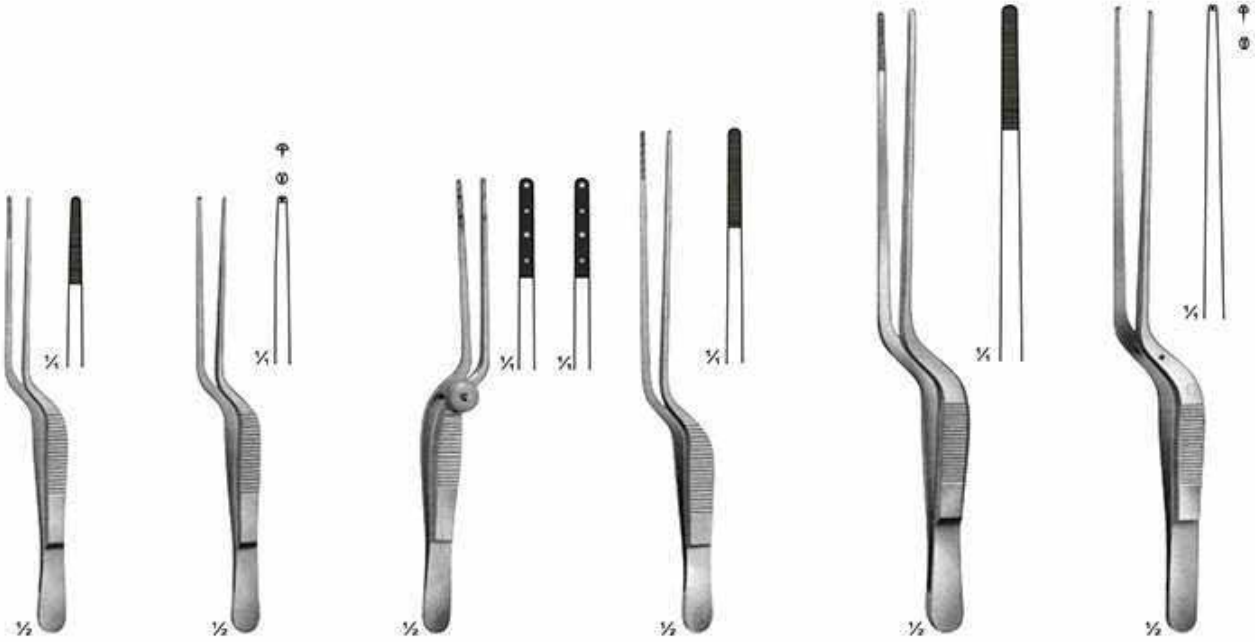

04-233
LUCAE
140 mm

04-234
LUCAE
1x2 teeth
140 mm

04-235
COTTLE
Forceps with
jaws toothed
and serrated
140 mm

04-236
JANSEN
160 mm

04-237
GRUENWALD
200 mm

04-238
1x2 teeth
200 mm

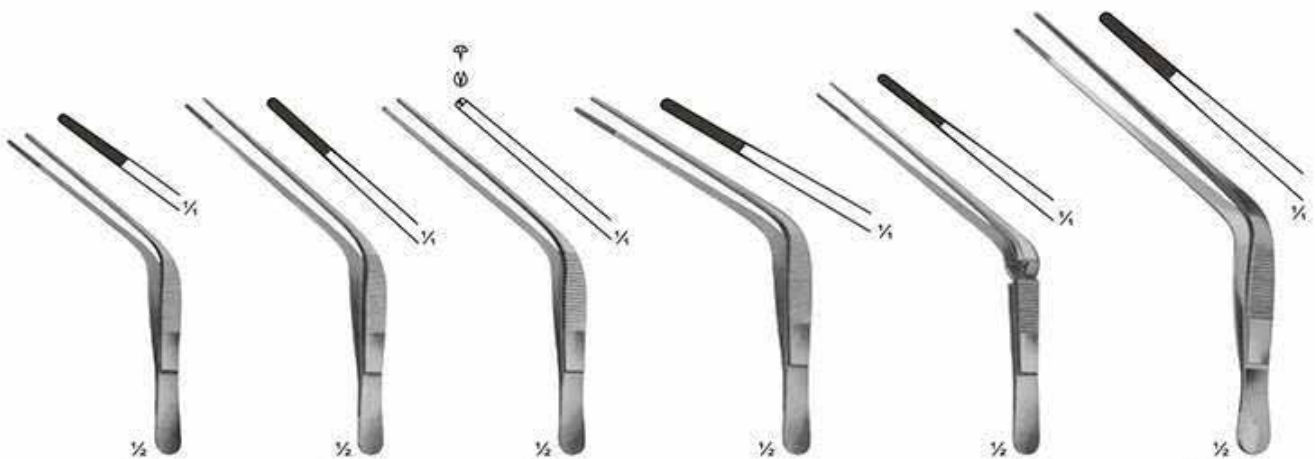

04-239
TROELTSCH
100 mm

04-240
TROELTSCH
115 mm

04-241
TROELTSCH
1X2 teeth
115 mm

04-242
WILDE
115 mm

04-243
TROELTSCH
Cross action
120 mm

04-244
TROELTSCH
140 mm

Forceps

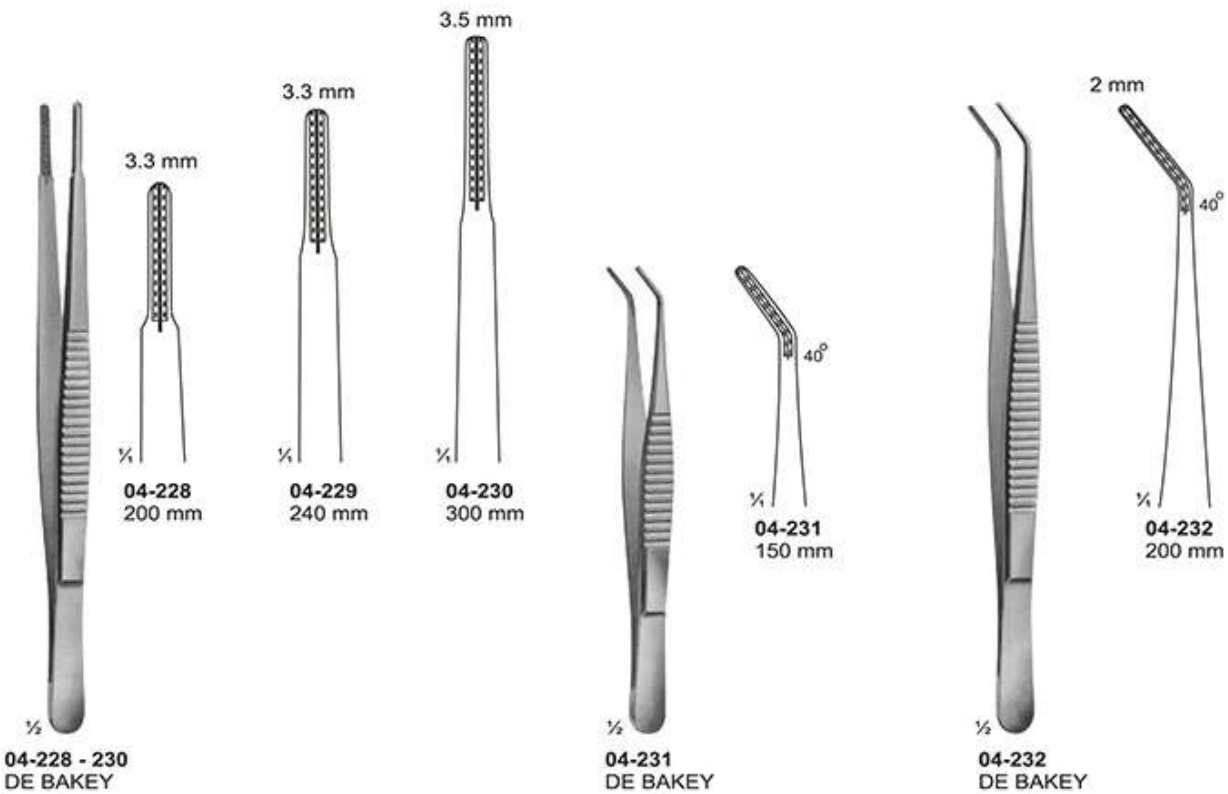
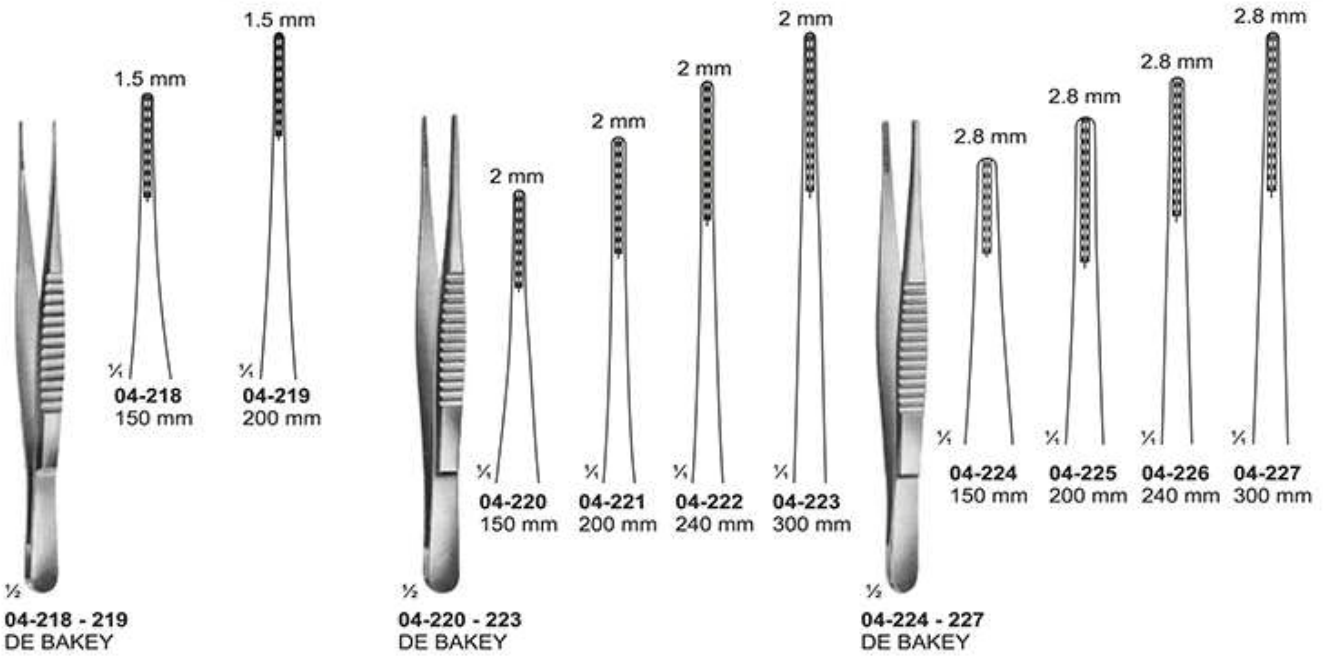

Ultra-Light Forceps

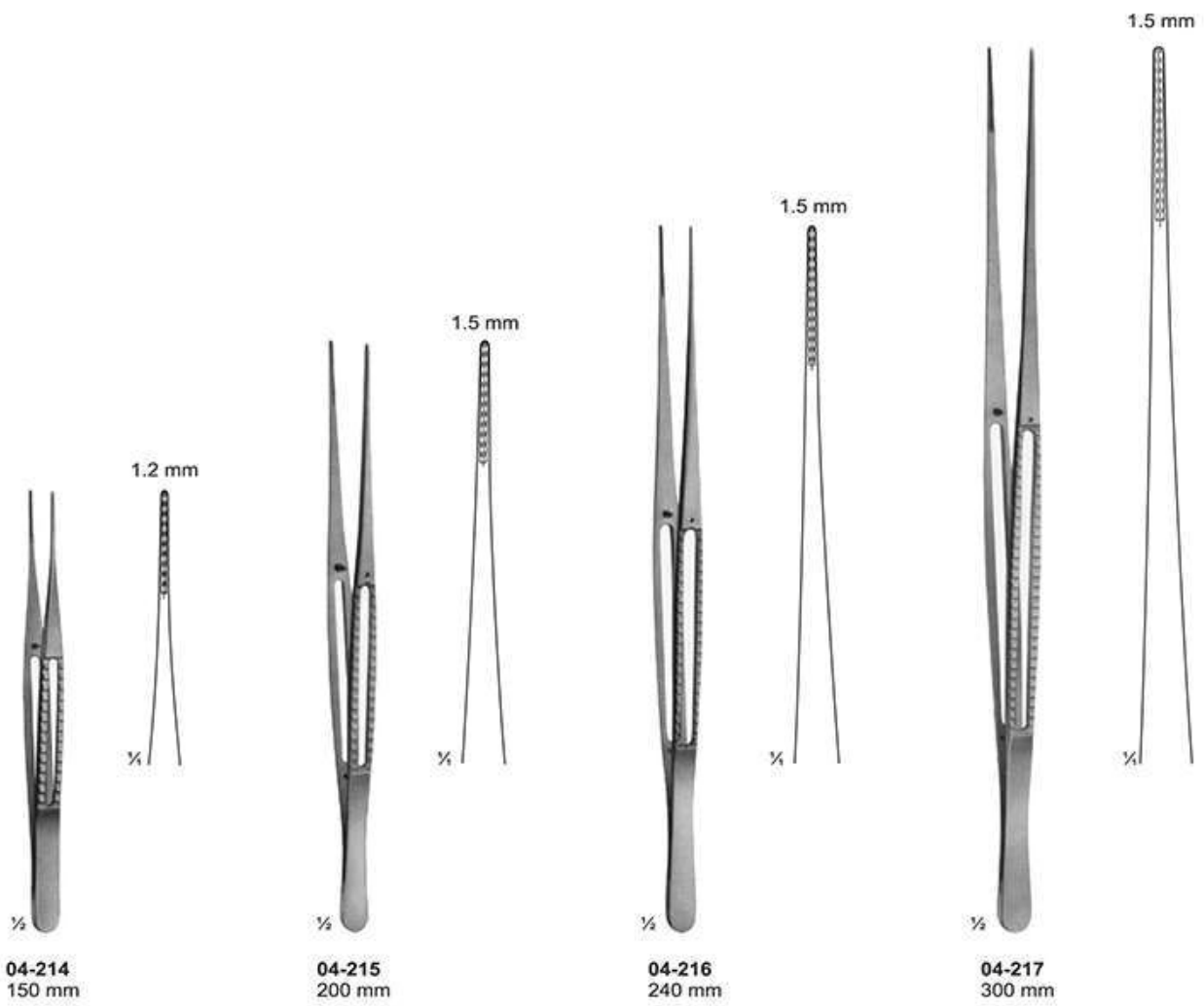

Dissecting Forceps



04-205 - 206



04-205
125 mm



04-206
155 mm



04-207 - 210



04-207
130 mm



04-208
150 mm



04-209
170 mm



04-210
200 mm



04-211
OCHSNER



04-212
FRICKE



04-213
BONNEY



Dissecting Forceps



04-190 - 197
STANDARD

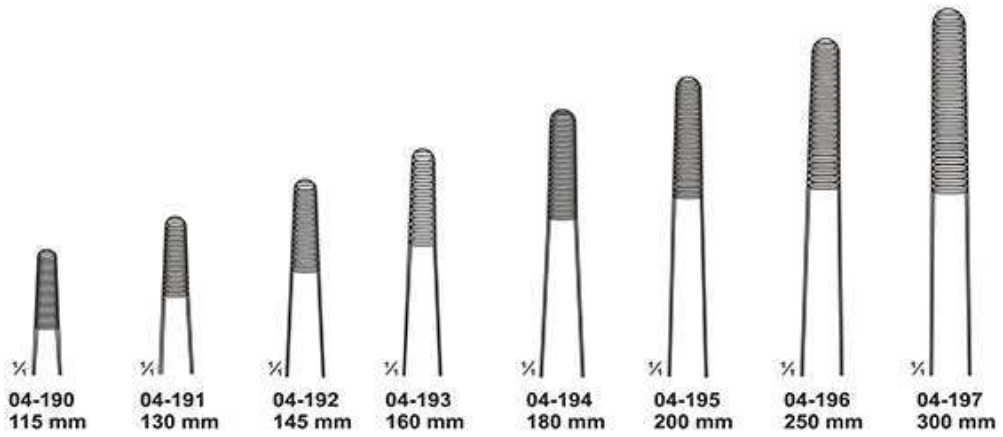

04-198 - 202
MEDIUM

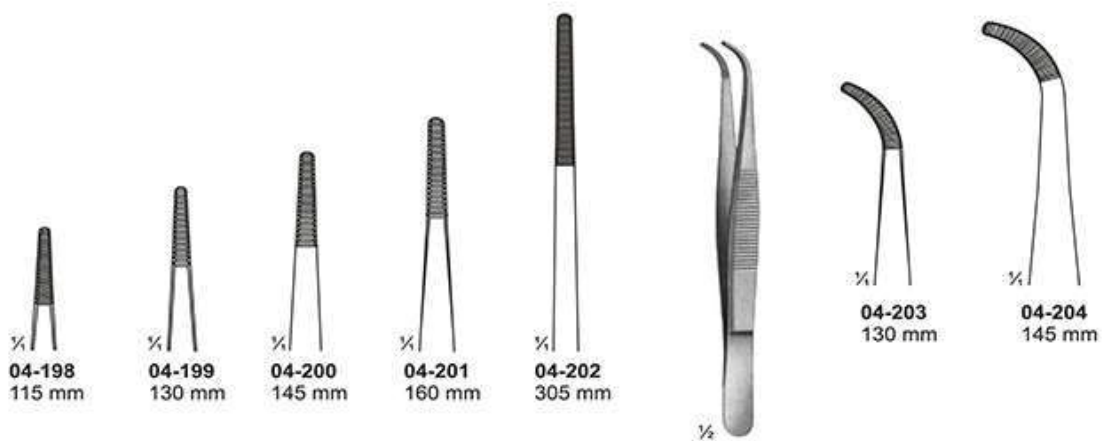

04-203 - 204
MEDIUM

Delicate Dissecting Forceps

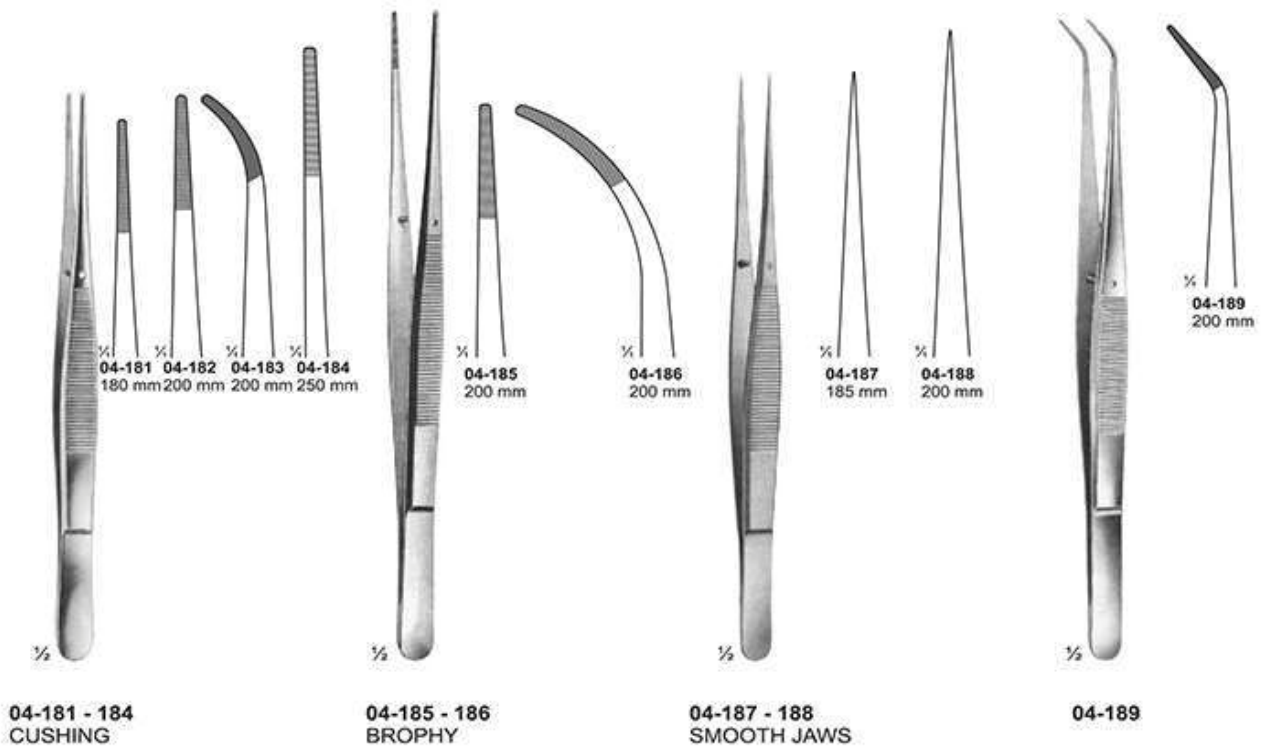
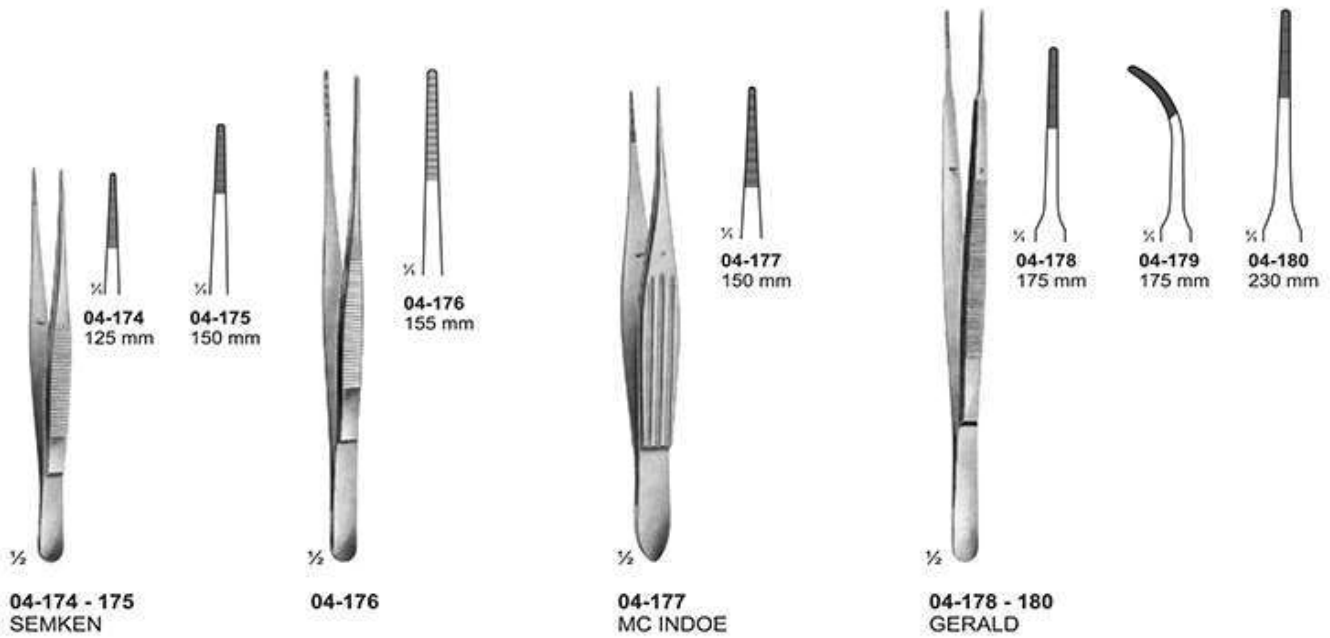

Delicate Dissecting, Microscopic, Sterilizing Forceps

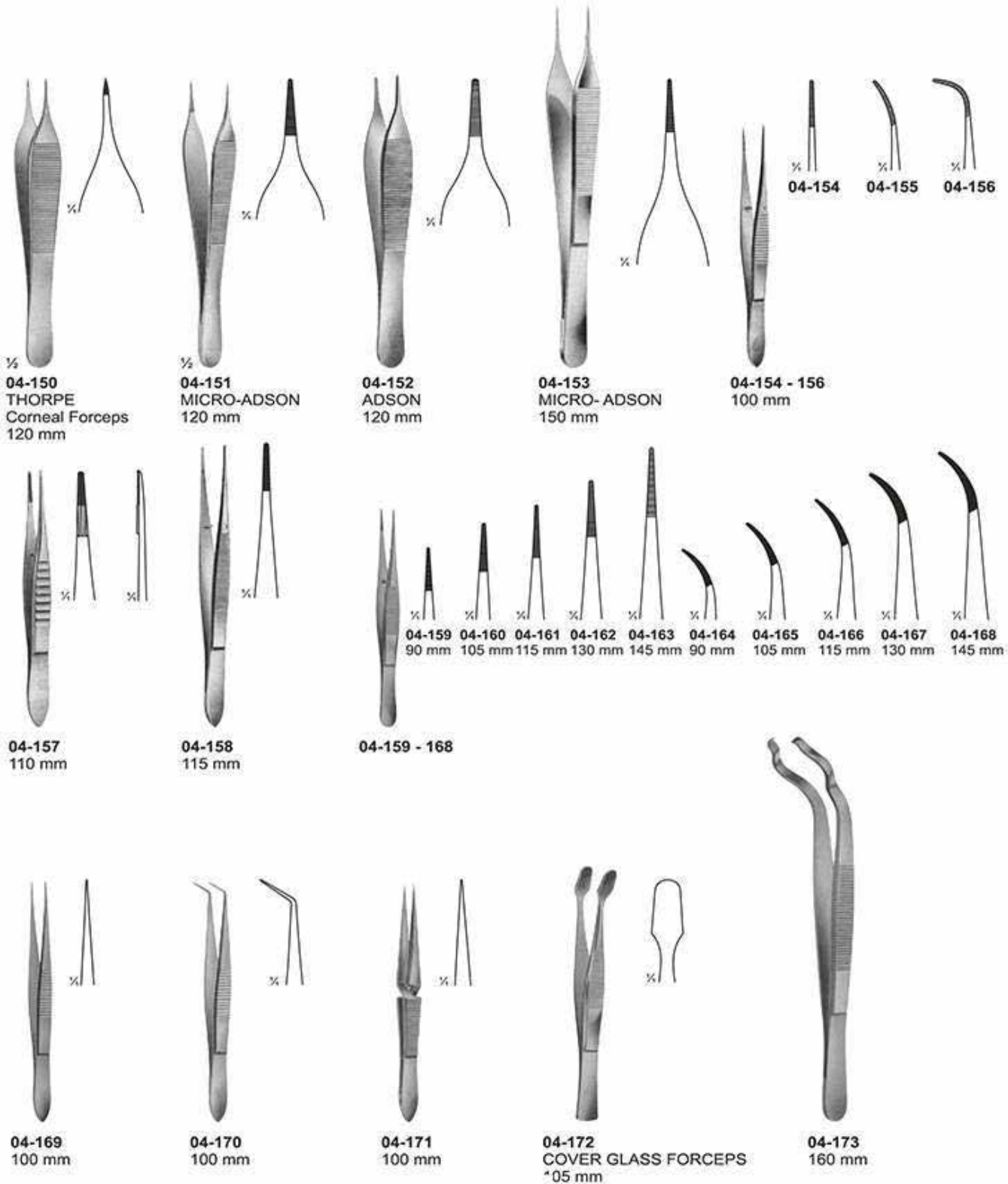

Bandage, Cloth and Plaster Scissors

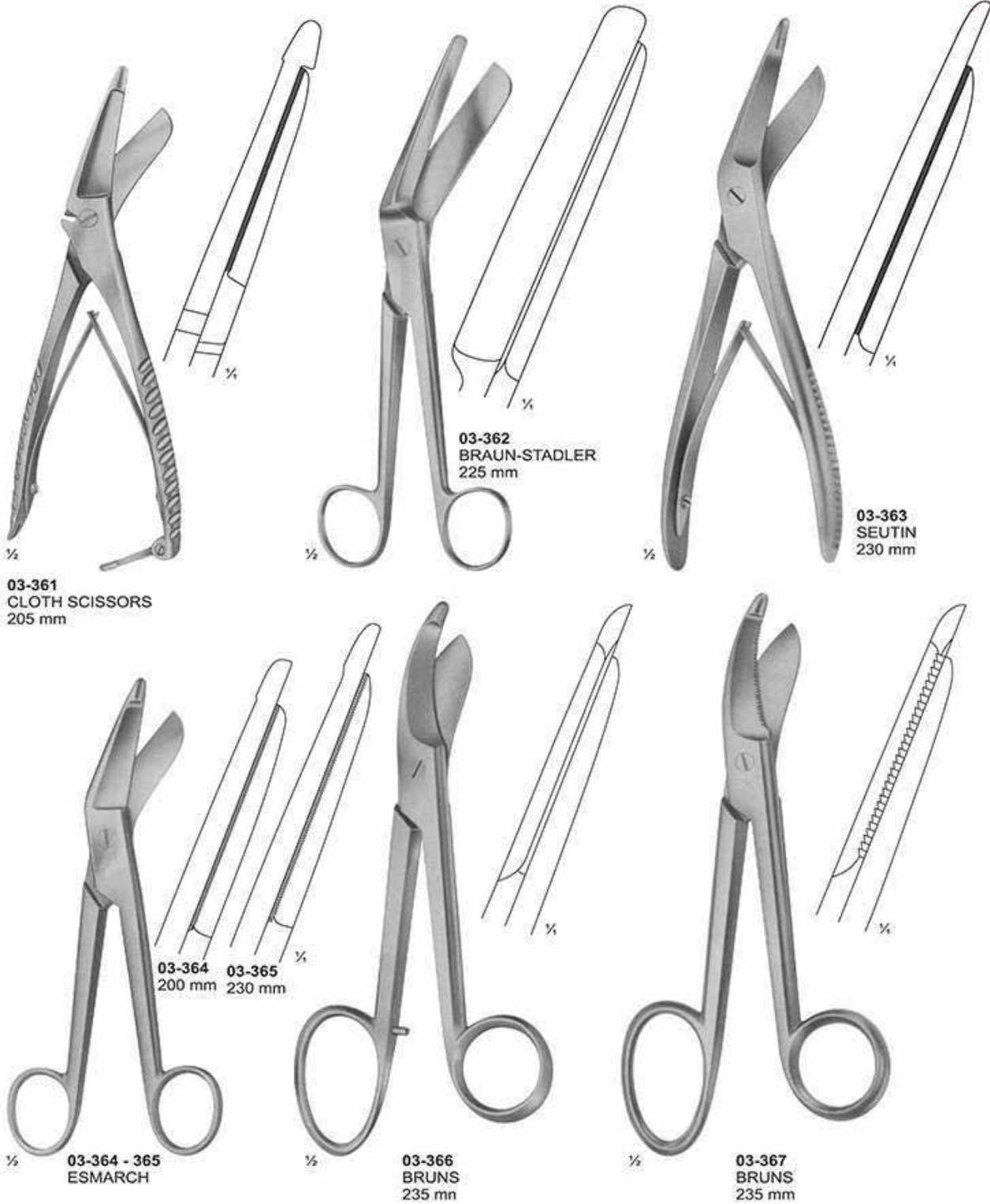

Bandage and Cloth Scissors



03-352
UNIVERSAL AND BANDAGE SCISSORS
180 mm

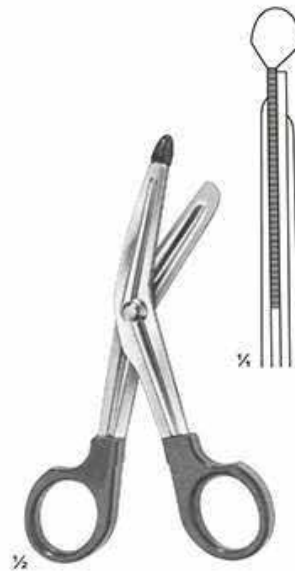

03-353
LISTER
Size: 145 mm

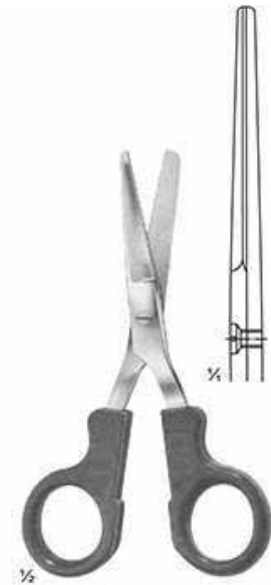

03-354
LISTER
Size: 145 mm

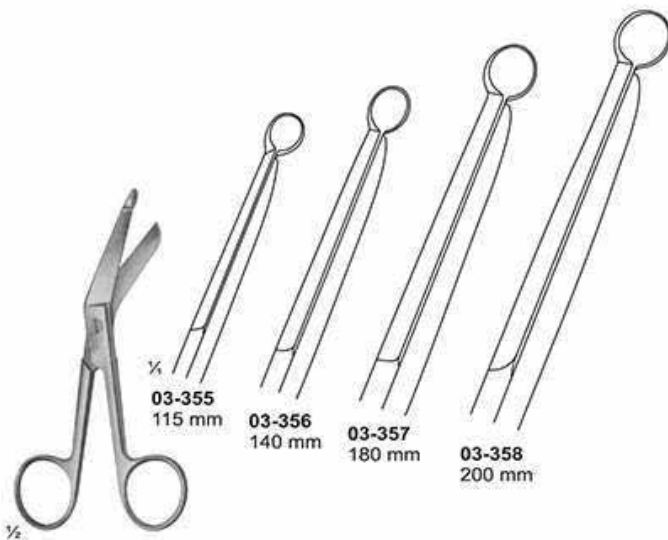

03-355 - 358
LISTER

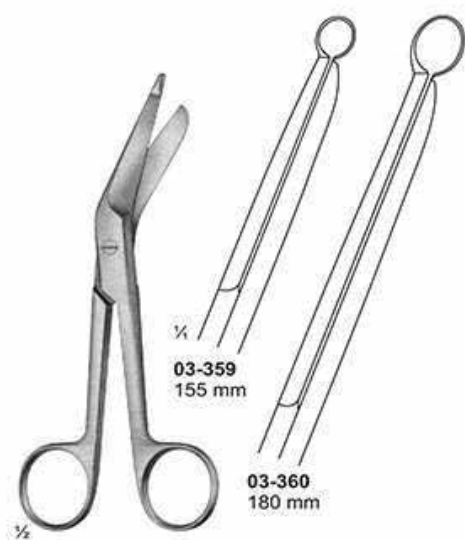

03-359 - 360
LISTER

Wire and Plate Scissors

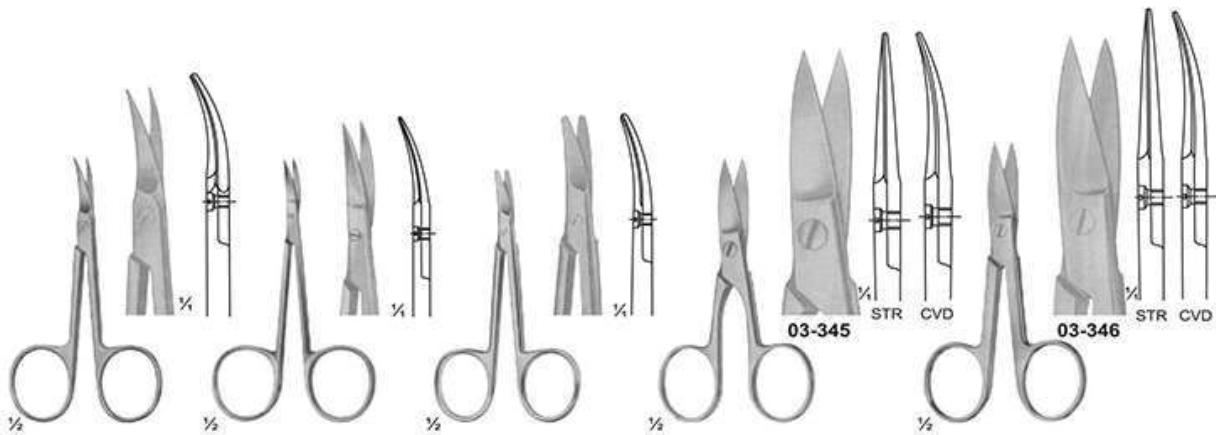

03-342
NAIL SCISSORS
Size: 90 mm

03-343
NAIL SCISSORS
Size: 90 mm

03-344
BABY NAIL SCISSORS
Size: 85 mm

03-345
NAIL SCISSORS
Size: 90 mm

03-346
NAIL SCISSORS
Size: 90 mm



03-347
KNOWLES
Size: 140 mm

03-348
KNOWLES
Size: 145 mm

03-349
Size: 150 mm

03-350
SMITH
Size: 180 mm

03-351
Size: 310 mm

Wire and Plate Scissors

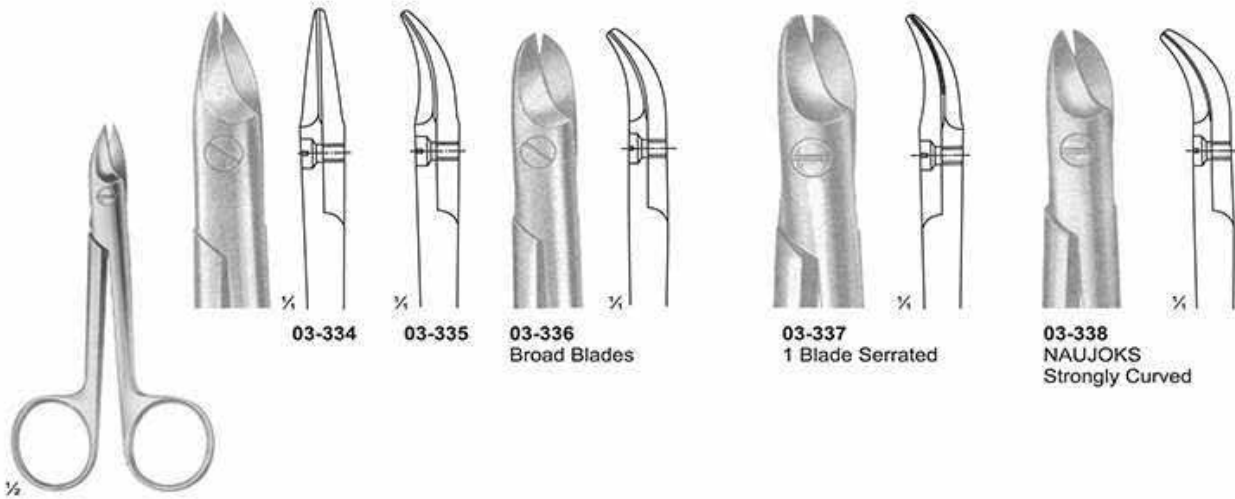

03-334 - 338
BEEBE
Size: 110 mm

03-334

03-335

03-336
Broad Blades

03-337
1 Blade Serrated

03-338
NAUJOKS
Strongly Curved

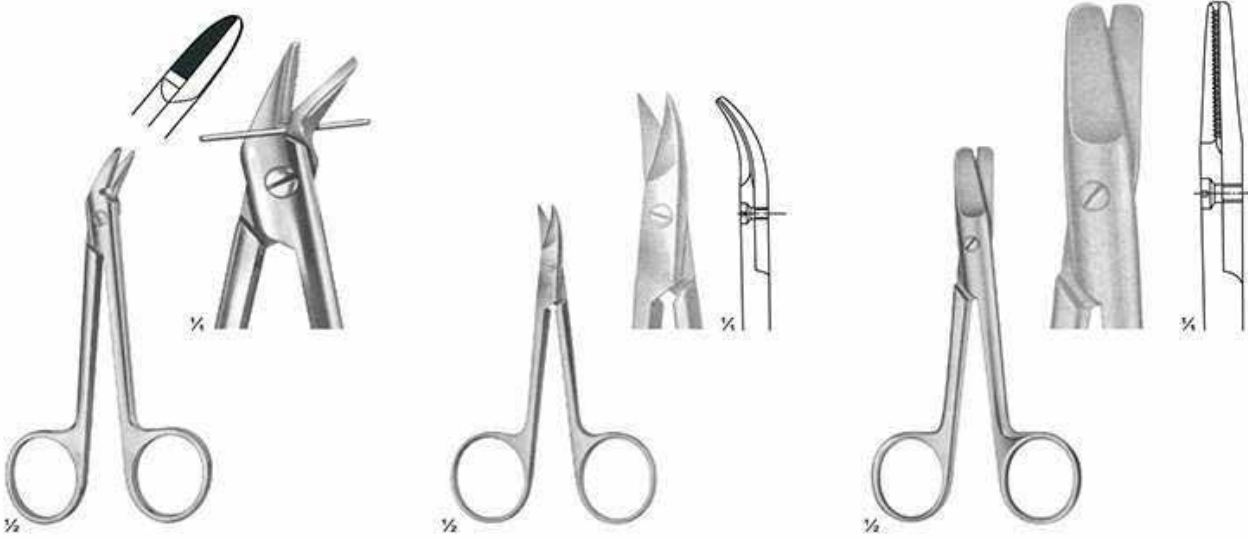

03-339
1 Blade Serrated
Size: 120 mm

03-340
STRACK
Size: 100 mm

03-341
HARVEY
Size: 125 mm

Ligature Scissors

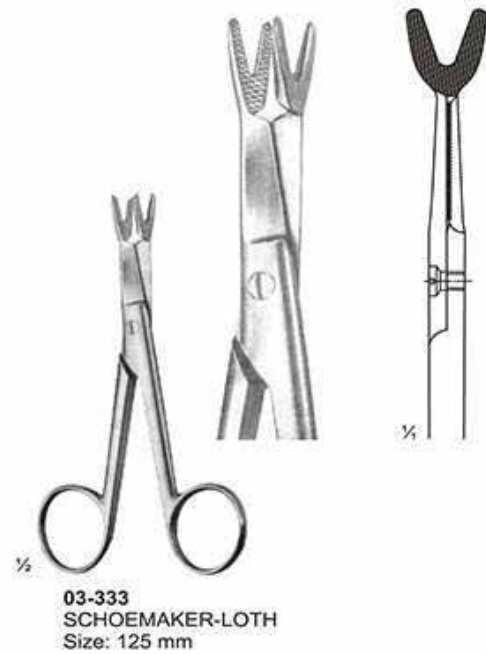
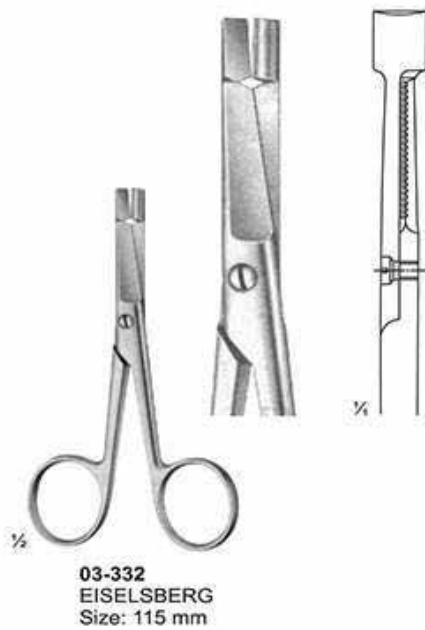
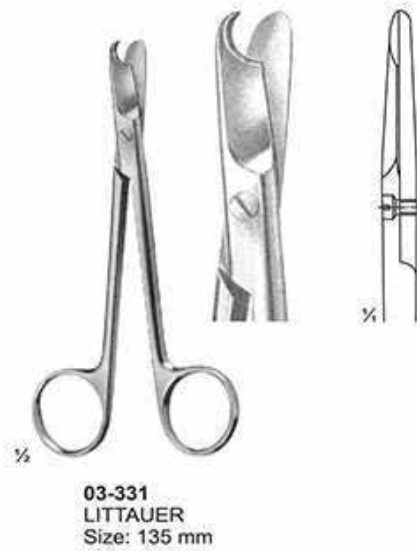
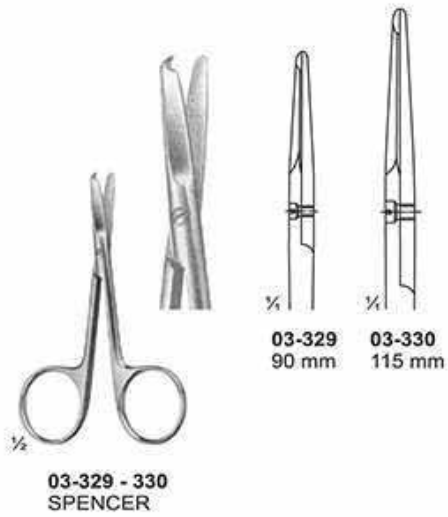

Bowel Scissors, Cartilage Scissors

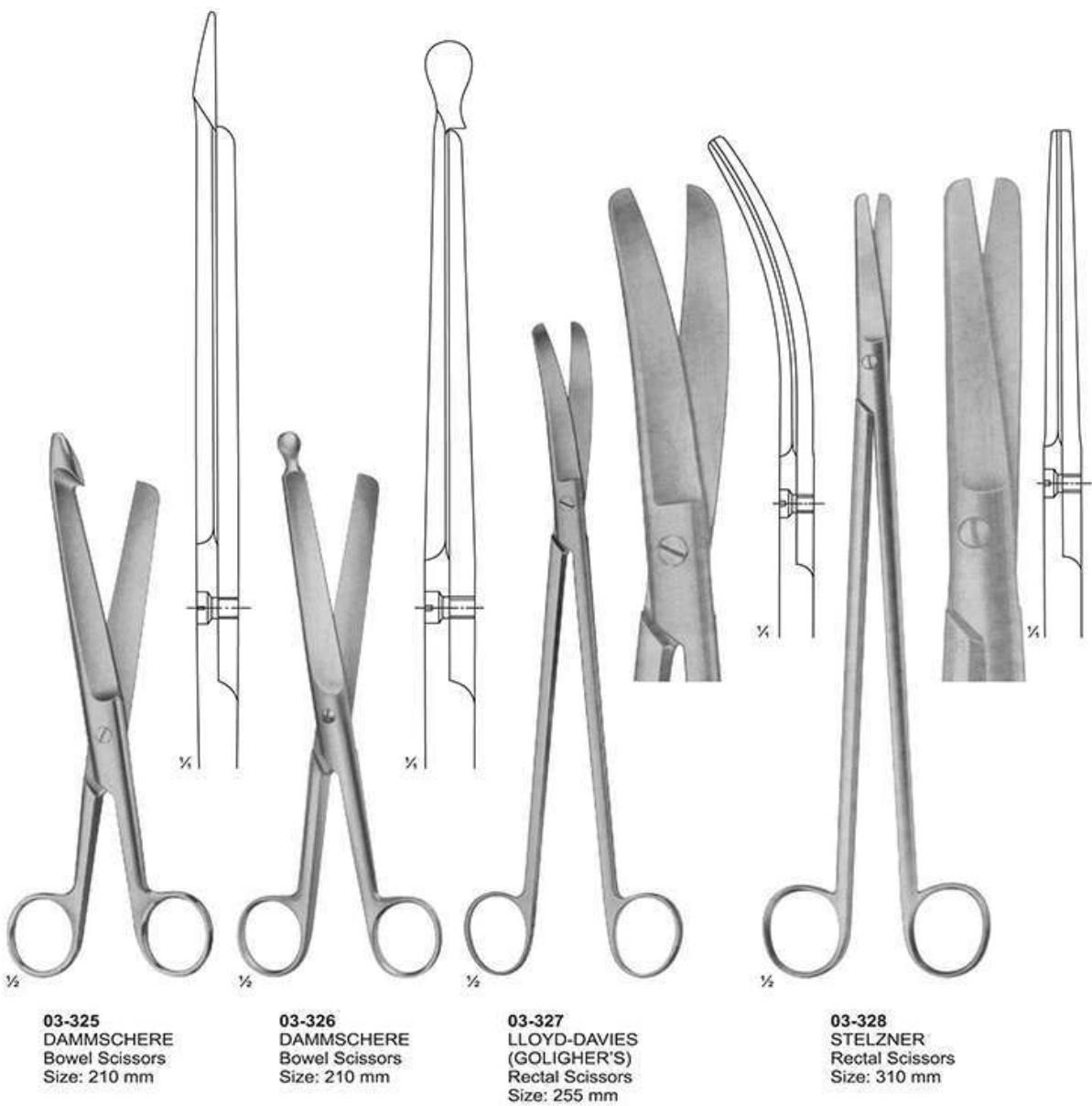

Operating and Gynaecology Scissors

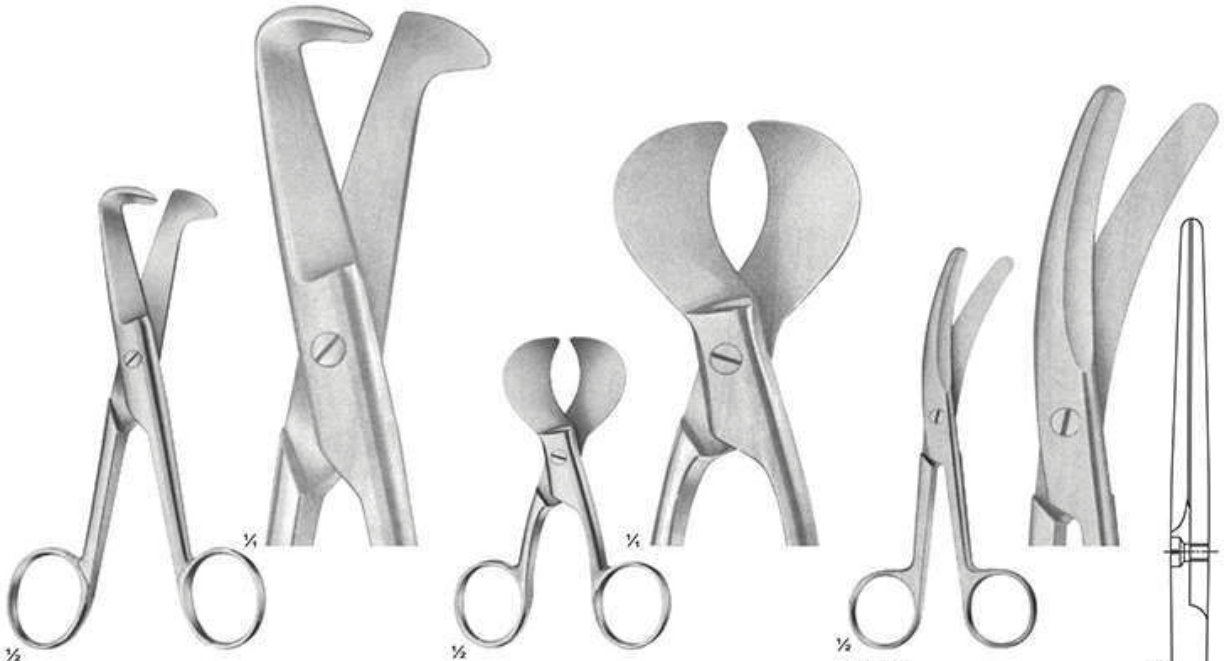

03-319
SCHUMACHER
Umbilical Cord Scissors
Size: 155 mm

03-320
Umbilical Cord Scissors
Size: 105 mm

03-321
Umbilical Cord Scissors
135 mm

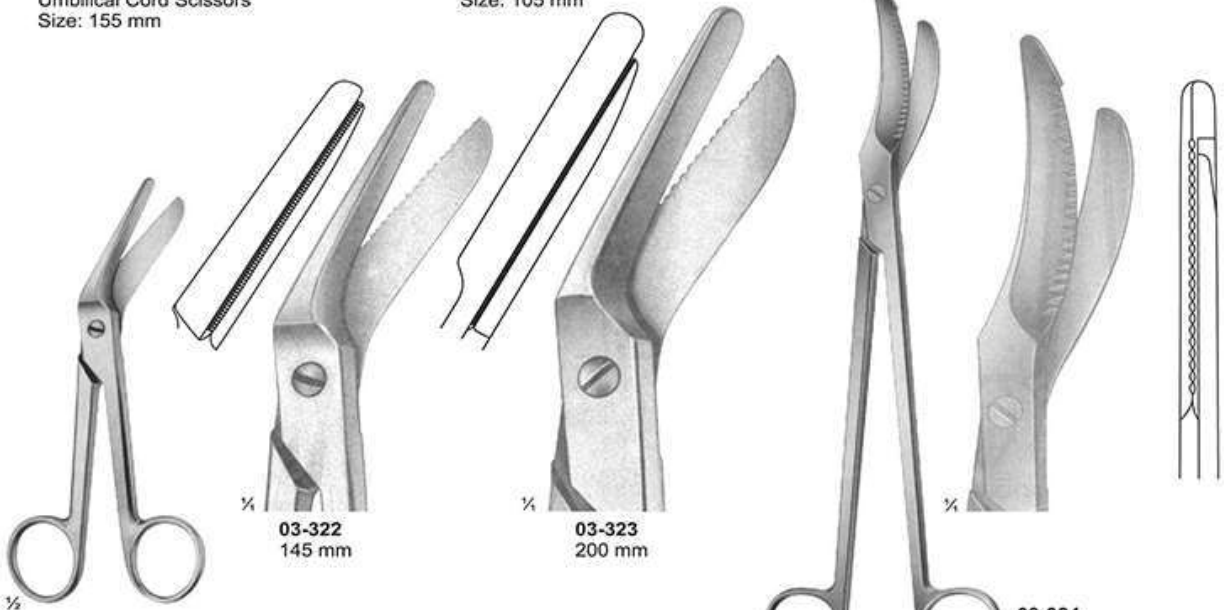

03-322 - 323
BRAUN-STADLER
Empisiotomy Scissors

03-322
145 mm

03-323
200 mm

03-324
DAMMSCHERE
Empisiotomy Scissors
240 mm

Operating and Gynaecology Scissors

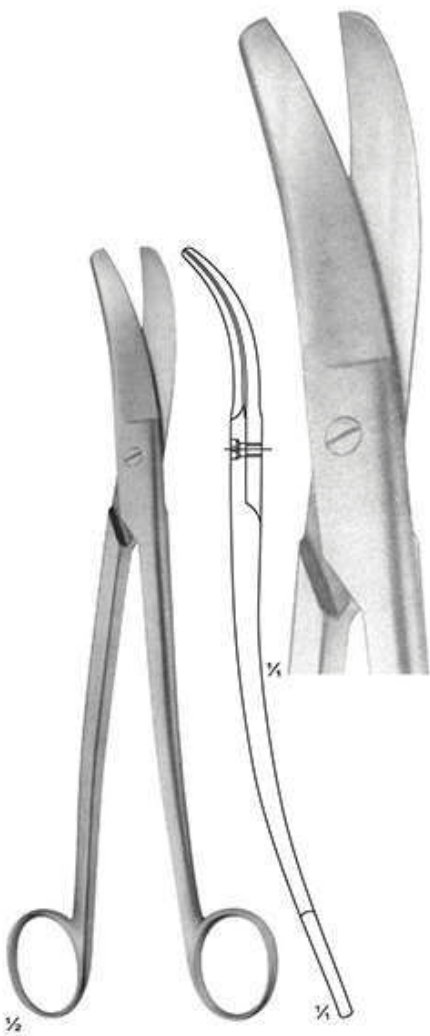

03-316
SIEBOLD
Uterine Scissors
Size: 245 mm

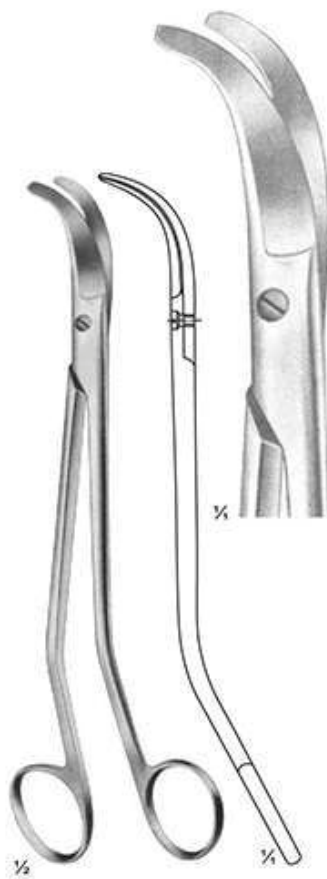

03-317
BOZEMANN
Uterine Scissors
Size: 220 mm

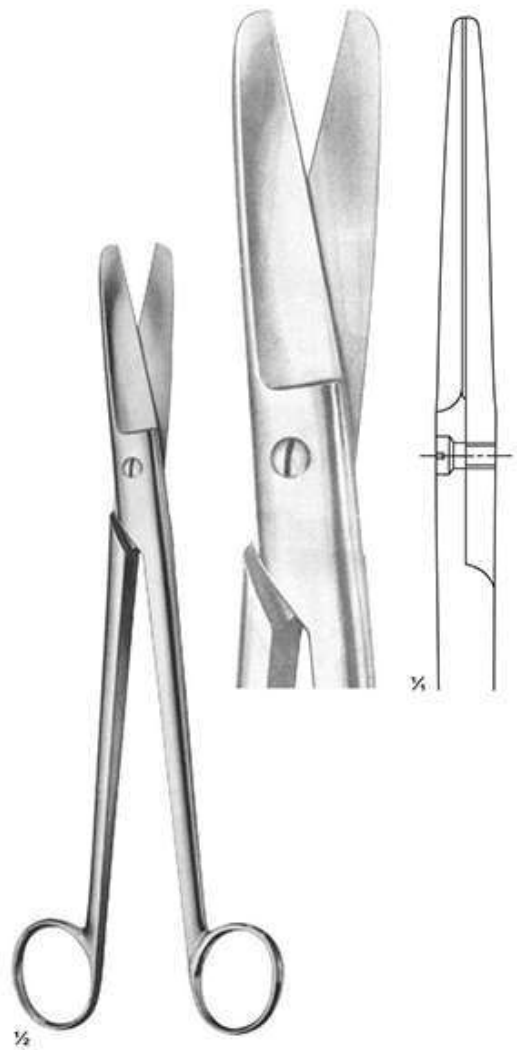

03-318
SIMS-SIEBOLD
Uterine Scissors
Size: 250 mm

Operating and Gynaecology Scissors

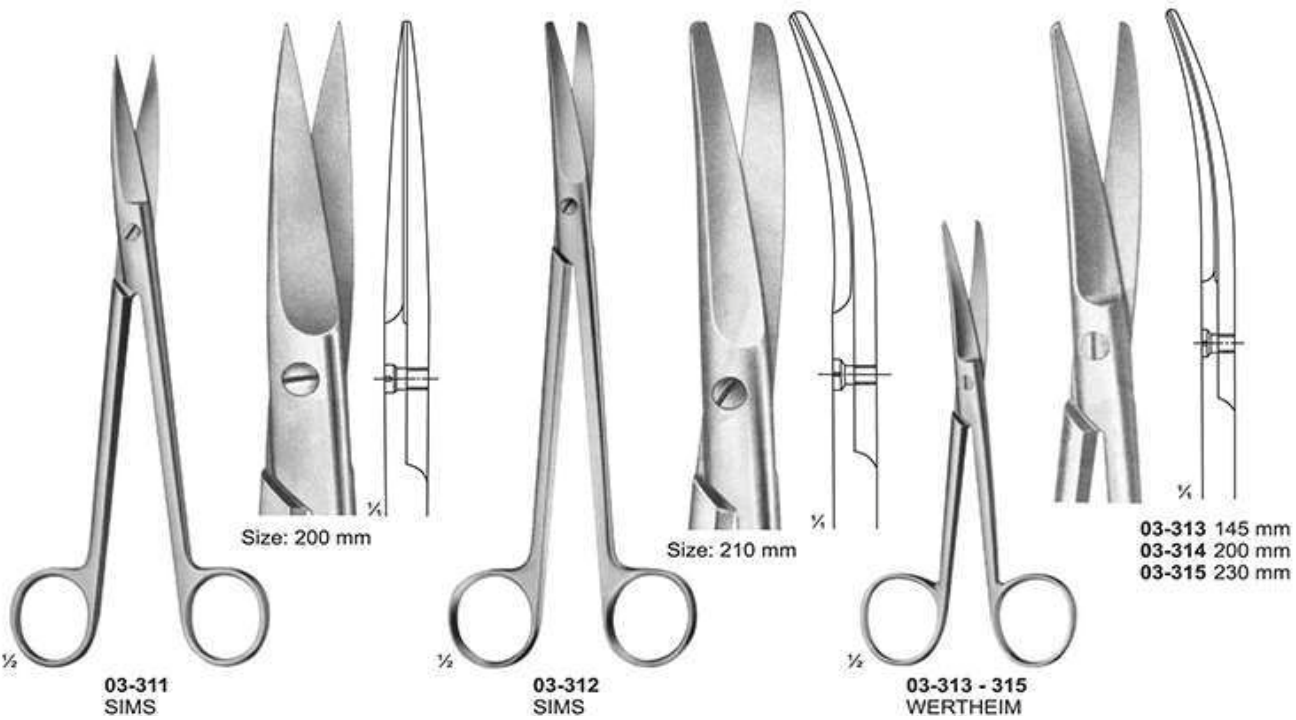
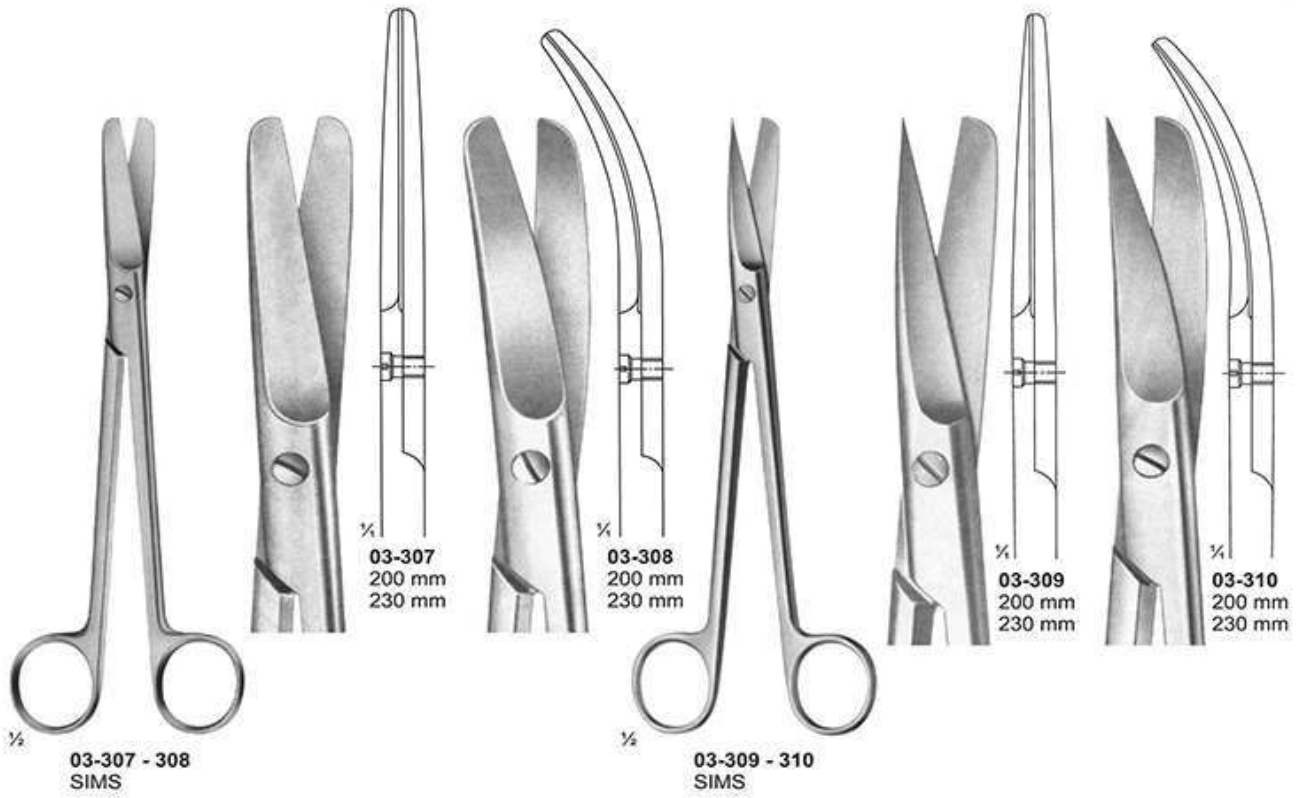

Bone Shears

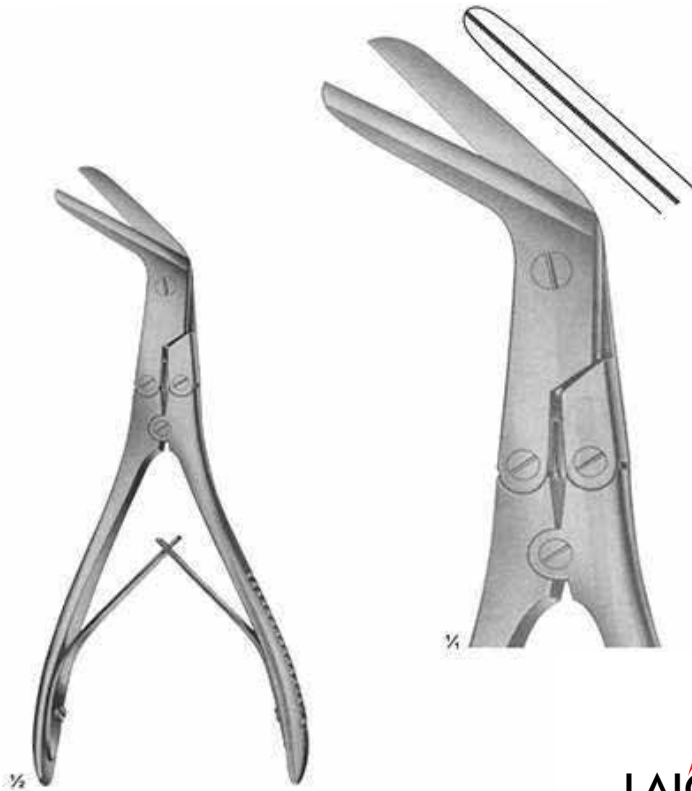

03-304
KILLIAN
Size: 200 mm

LAIQA NOOR
ENTERPRISES



03-305 - 306



03-305
195 mm

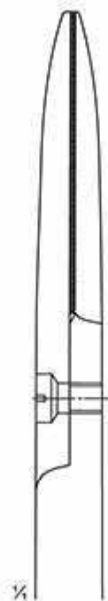

1/2



03-306
225 mm

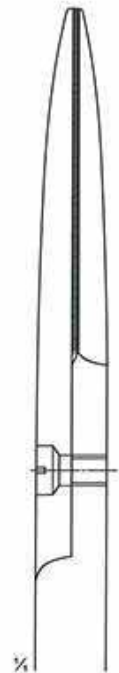

1/2

Delicate, Nasal and Tonsil Scissors



03-297
1 Finely Toothed Blade
Size: 130 mm

03-298
LOCKLIN
Curved Sideways,
1 Toothed Blade
Size: 155 mm

03-299
FOMON
Blades Serrated
Size: 145 mm

03-300
COTTLE
Size: 165 mm

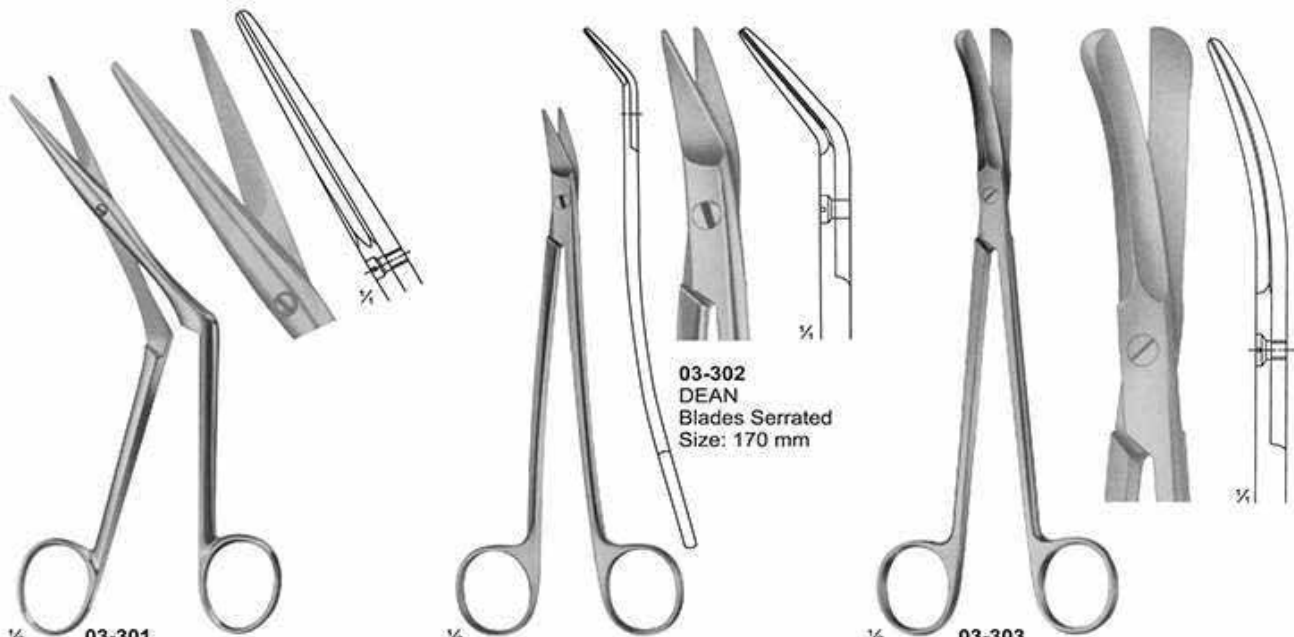

03-301
HEYMANN-KNIGHT
Size: 175 mm

03-302
DEAN
Blades Serrated
Size: 170 mm

03-303
GOOD
Size: 195 mm

Cardiovascular and Neuro-Surgery Scissors

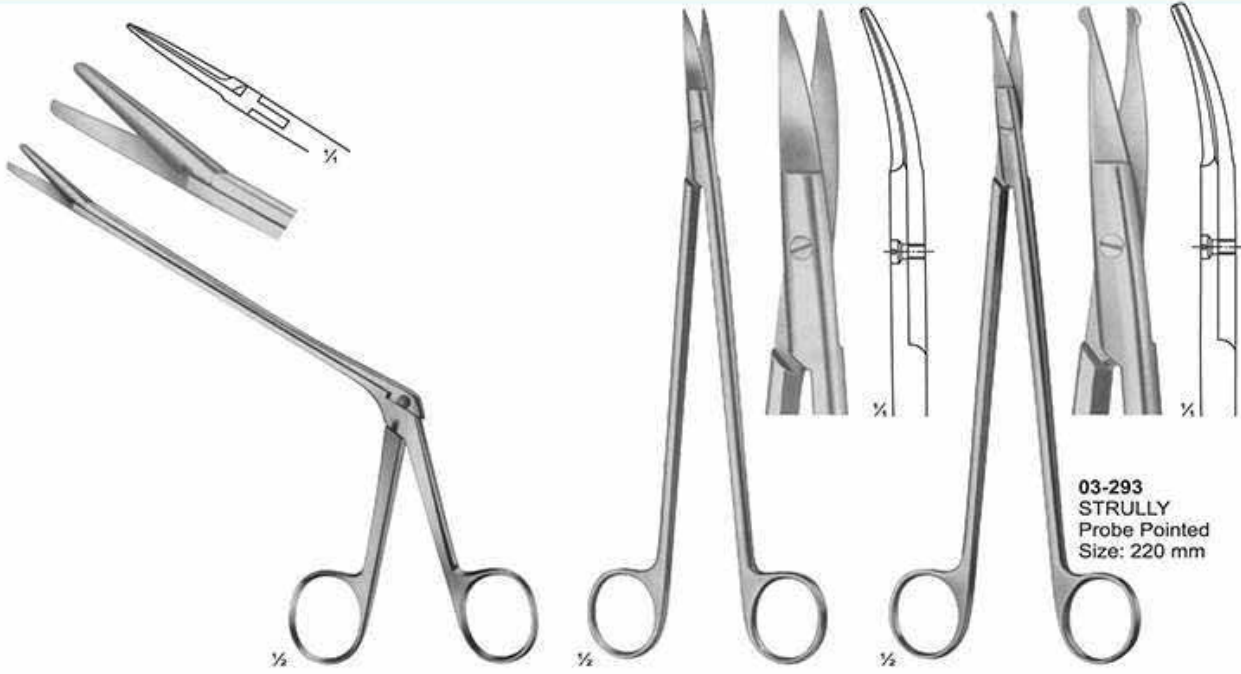

03-291
OLIVECRONA
Dura Scissors

03-292
STRULLY
Pointed
Size: 220 mm

03-293
STRULLY
Probe Pointed
Size: 220 mm

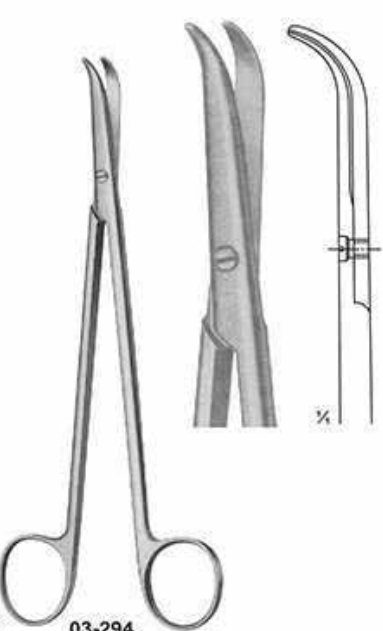

03-294
THOREK
Size: 180 mm

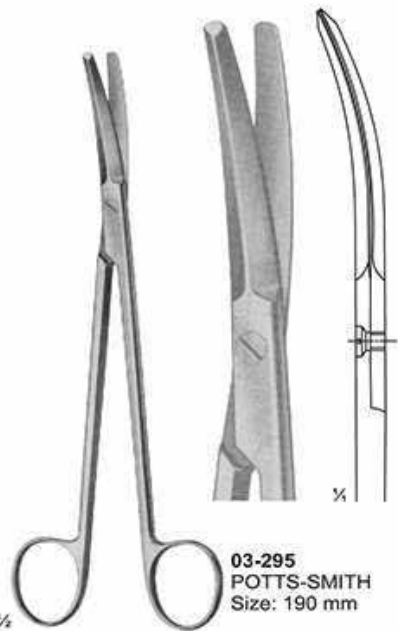

03-295
POTTS-SMITH
Size: 190 mm

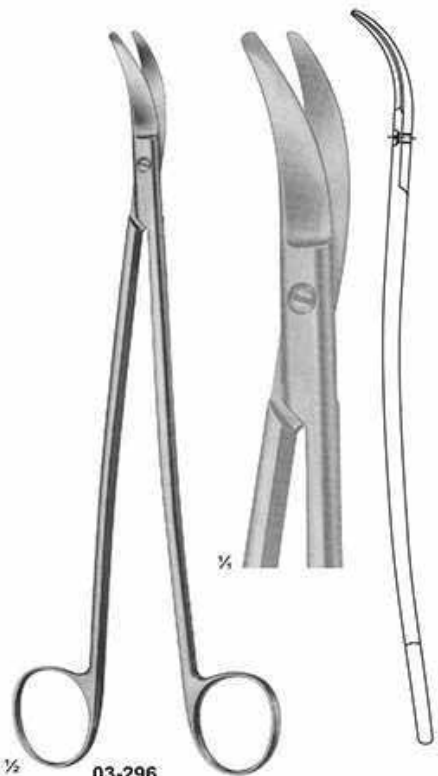

03-296
SATINSKY
Size: 245 mm

Vessel Scissors

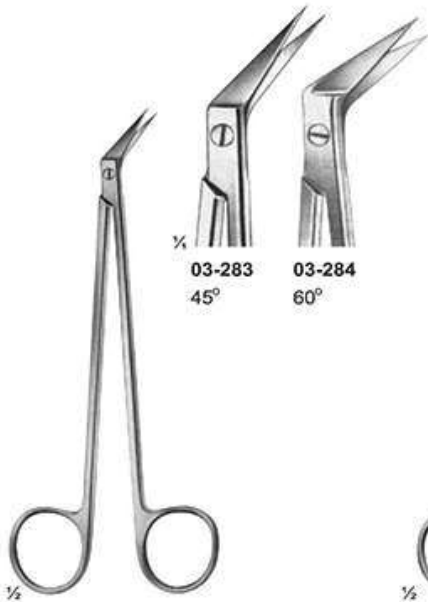

03-283
45°

03-284
60°

03-283 - 284
DE BAKEY
Size: 155 mm

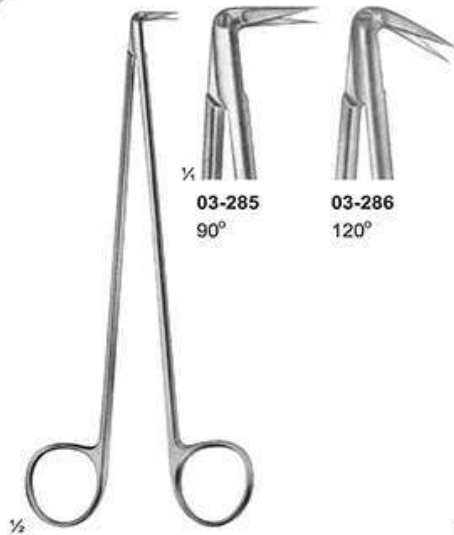

03-285
90°

03-286
120°

03-285 - 286
DIETRICH
Size: 170 mm

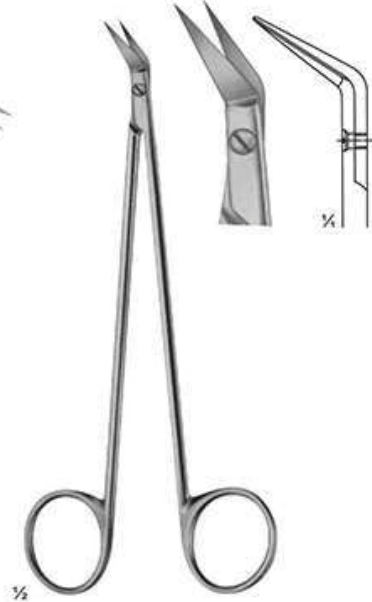

03-287
POTTS-SMITH
Size: 180 mm

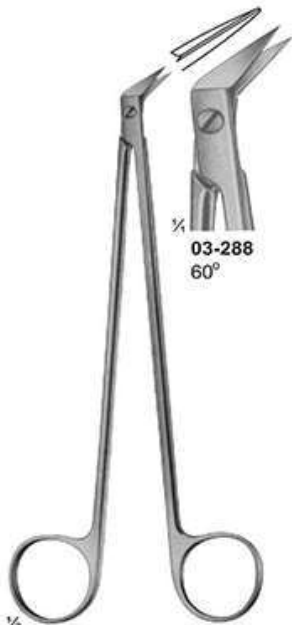

03-288
60°

03-288
POTTS-SMITH
Size: 180 mm

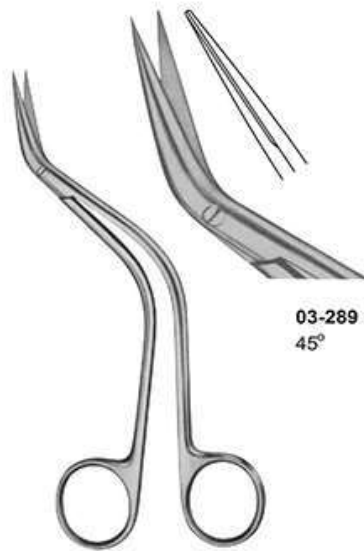

03-289
45°

03-289
DEBAKEY
Size: 155 mm



03-290
55°

03-290
FAVOLORO
Size: 140 mm

Dissecting Scissors

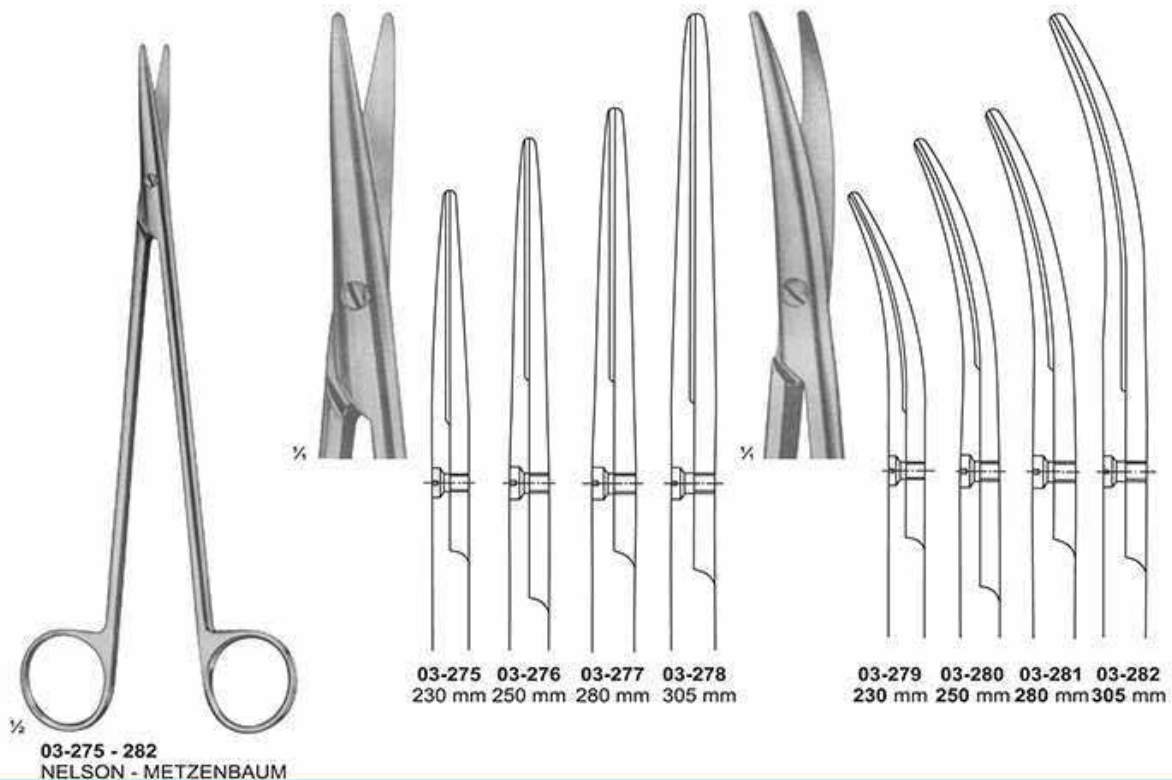
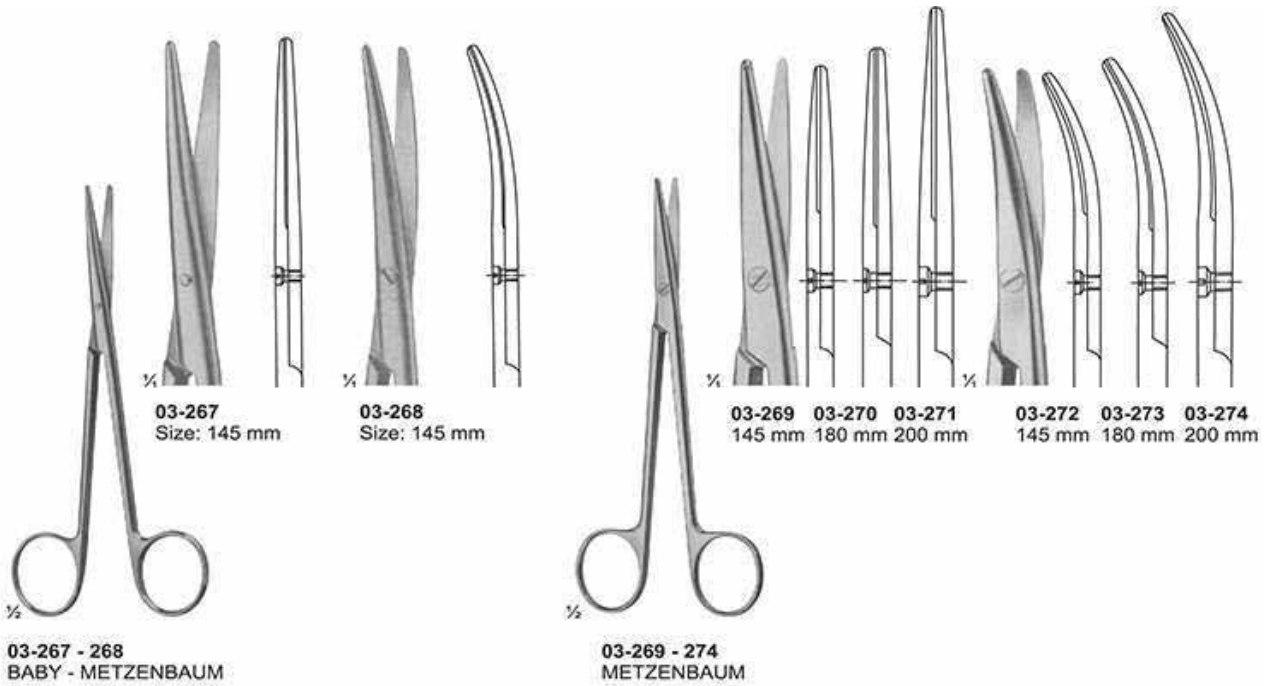

Dissecting Scissors

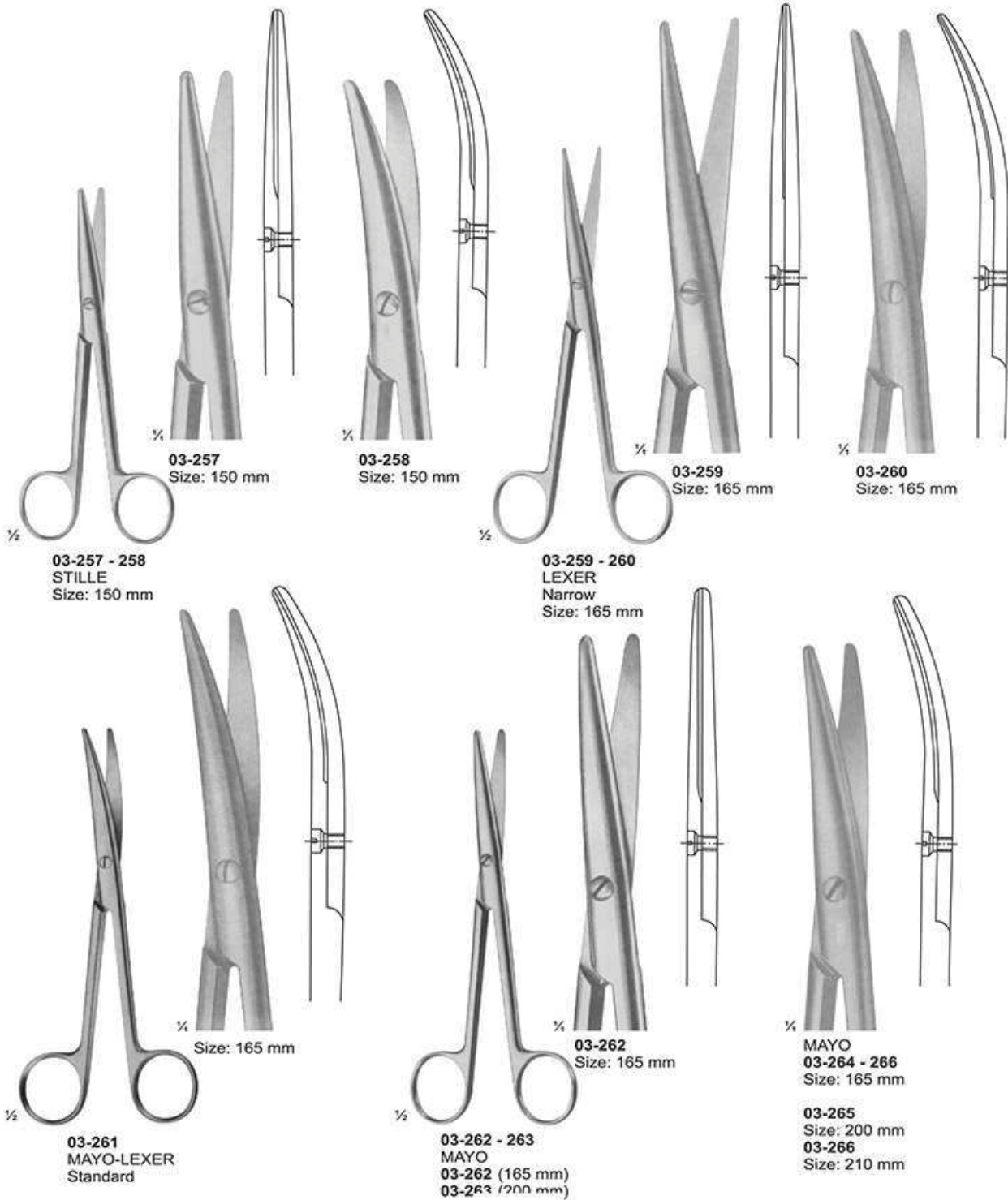

Dissecting Scissors

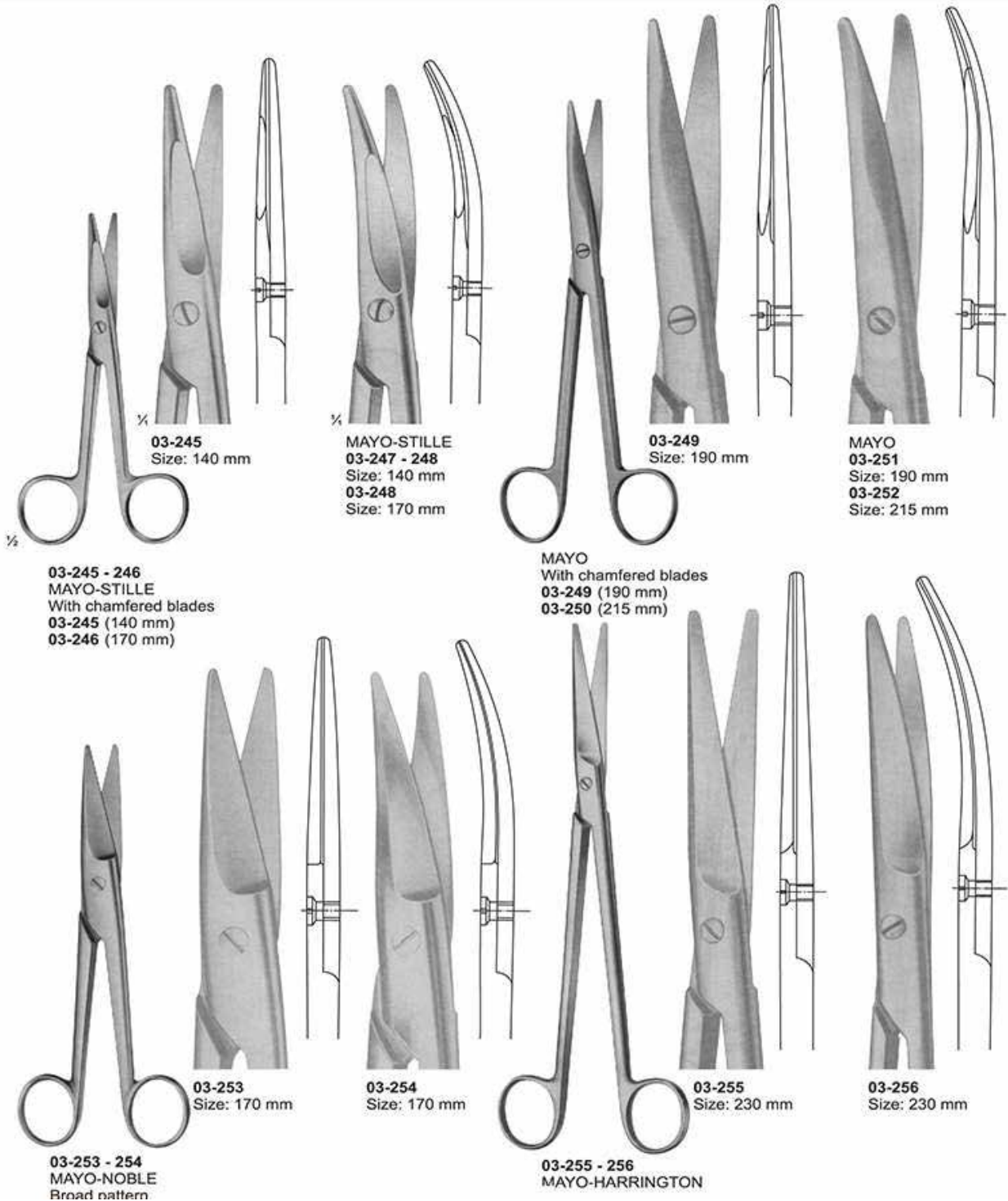

Dissecting & Surgical Scissors



03-231
Size: 115 mm

03-232
Size: 135 mm

03-233

03-234

03-231 - 232
FOMON
Lower lateral scissors

03-233 - 234
LANDOLT
Enucleation scissors
Size: 120 mm

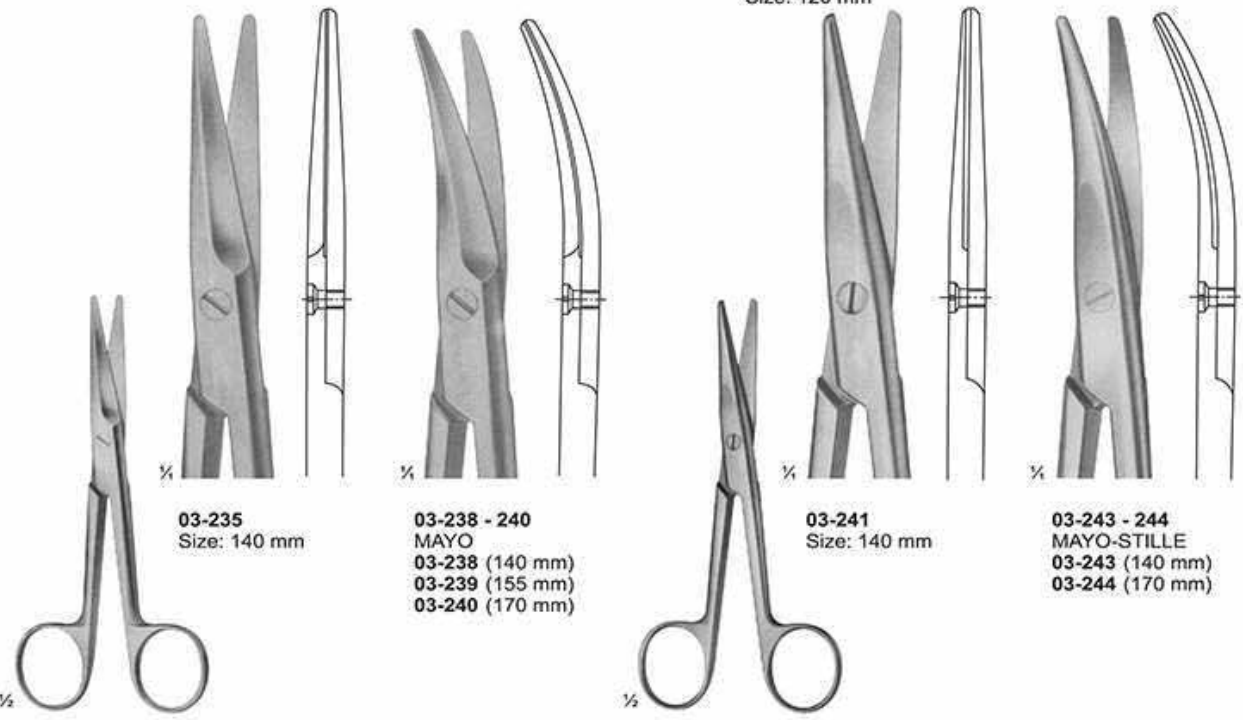

03-235
Size: 140 mm

03-238 - 240
MAYO
03-238 (140 mm)
03-239 (155 mm)
03-240 (170 mm)

03-241
Size: 140 mm

03-243 - 244
MAYO-STILLE
03-243 (140 mm)
03-244 (170 mm)

03-235 - 237
MAYO
03-235 (140 mm)
03-236 (155 mm)
03-237 (170 mm)

03-241 - 242
MAYO-STILLE
03-241 (140 mm)
03-242 (170 mm)

Dissecting Scissors

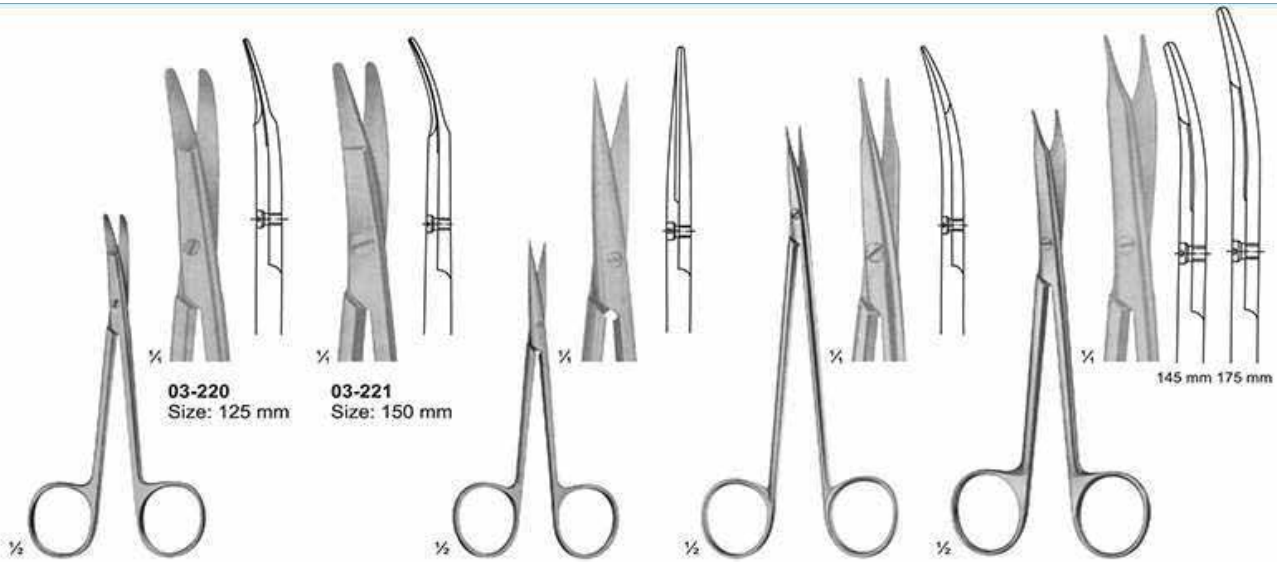

03-220 - 221
KILNER
Special flat points for dissecting and undermining the skin

03-222
KILNER
Fine dissecting scissors
Size: 115 mm

03-223
JAMESON
Dissecting scissors
Size: 150 mm

03-224
REYNOLDS
Dissecting scissors
Size: 145 - 175 mm



03-225
DE BAKEY
Ateriotomy scissors
Size: 175 mm

03-226 - 227
TOENNIS ADSON
Dissecting scissors
Size: 175 mm

03-228 - 230
TOENNIS
Dissecting scissors
Size: 150 mm

Dissecting Scissors

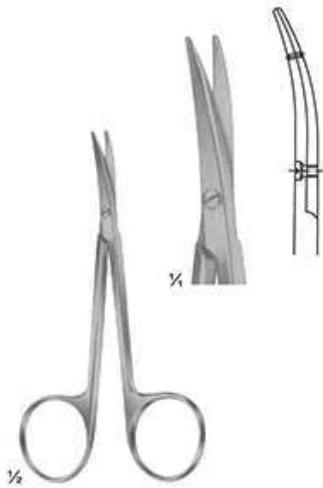

03-211
LITTLER
Dissecting Scissors
Tips with eye for suture
Size: 115 mm

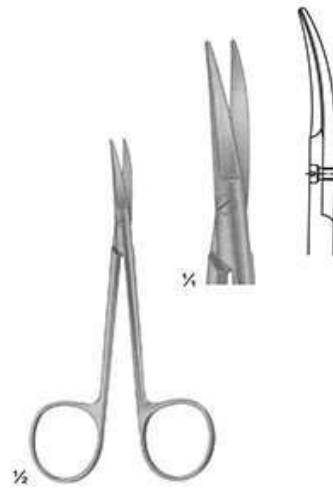

03-212
COTTLE
Bulldog Scissors
Size: 115 mm



03-213 **03-214**
Size: 100 mm Size: 100 mm

03-213 - 214
STEVENS
Vessel and tendon Scissors
Size: 100 mm

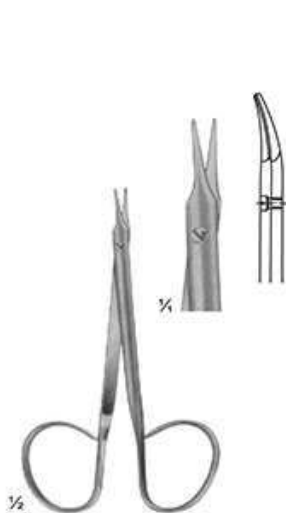

03-215
STEVENS
Fine Dissecting Scissors
Size: 110 mm

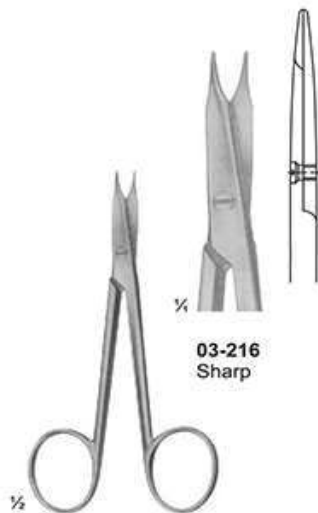

03-216 - 219
STEVENS
Vessel and tendon Scissors
Size: 110 mm

03-216
Sharp



03-217
Sharp



03-218
Blunt



03-219
Blunt

Surgical Scissors



03-204 - 206
DEAVER
With flat lock

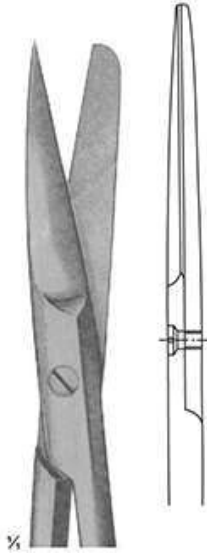

03-204
Size: 145 mm

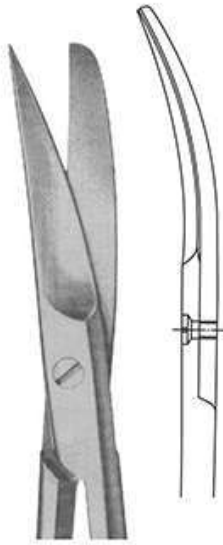

03-205
Size: 145 mm

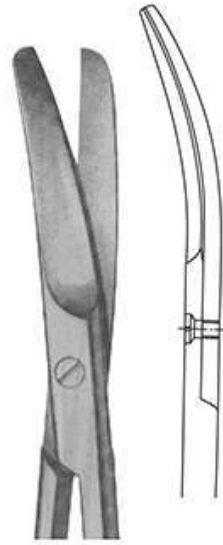

03-206
Size: 145 mm



03-207 - 209
Incision Scissors

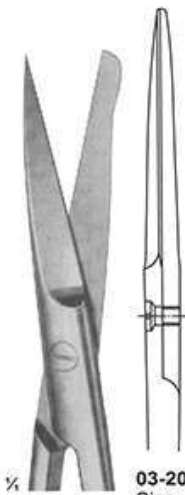

03-207
Size: 130 mm

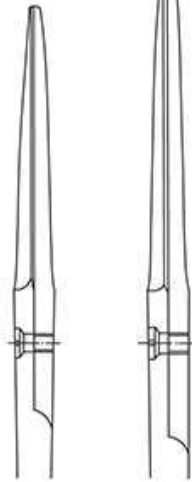

03-208
Size: 145 mm



03-209
Size: 165 mm



03-210
SYSTRUNK
Nail Splitting Scissors

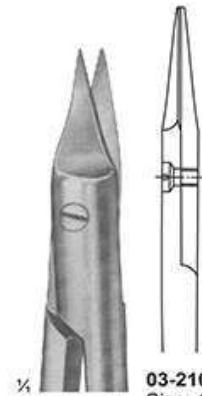

03-210
Size: 130 mm

Surgical Scissors

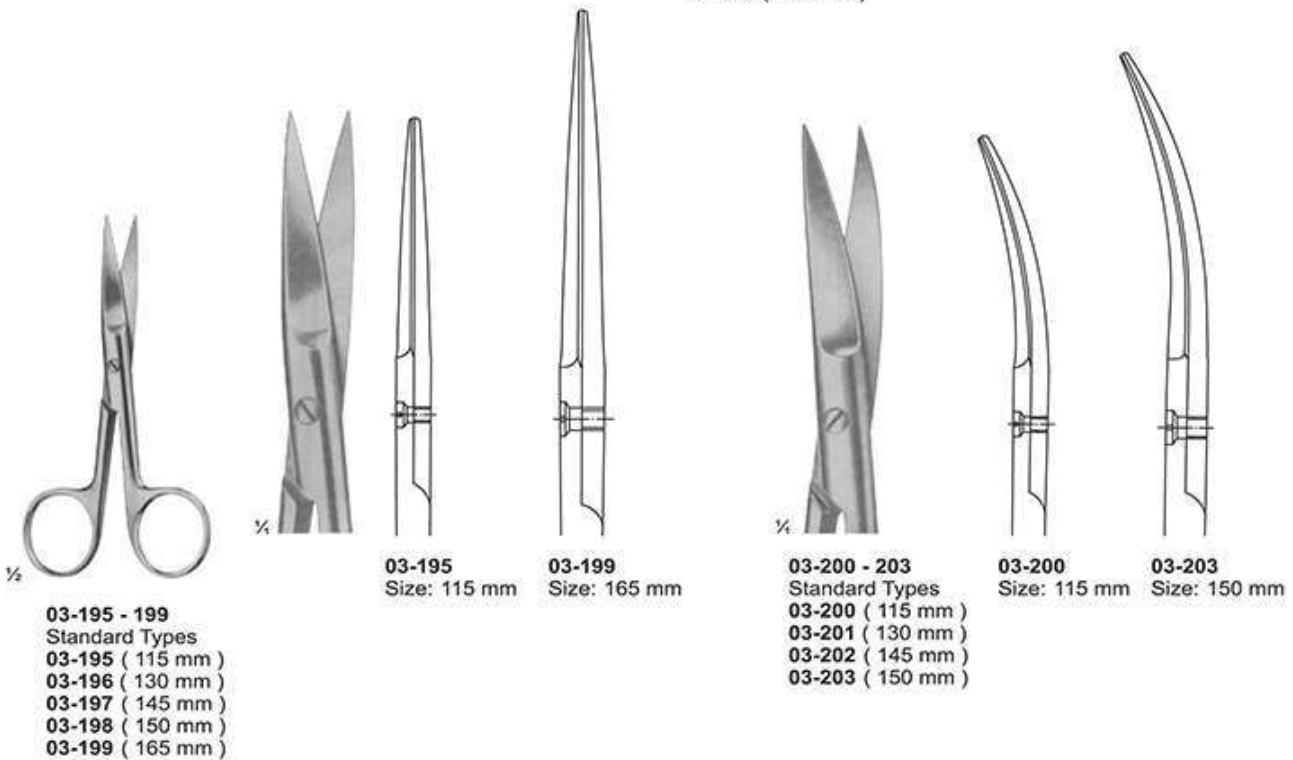
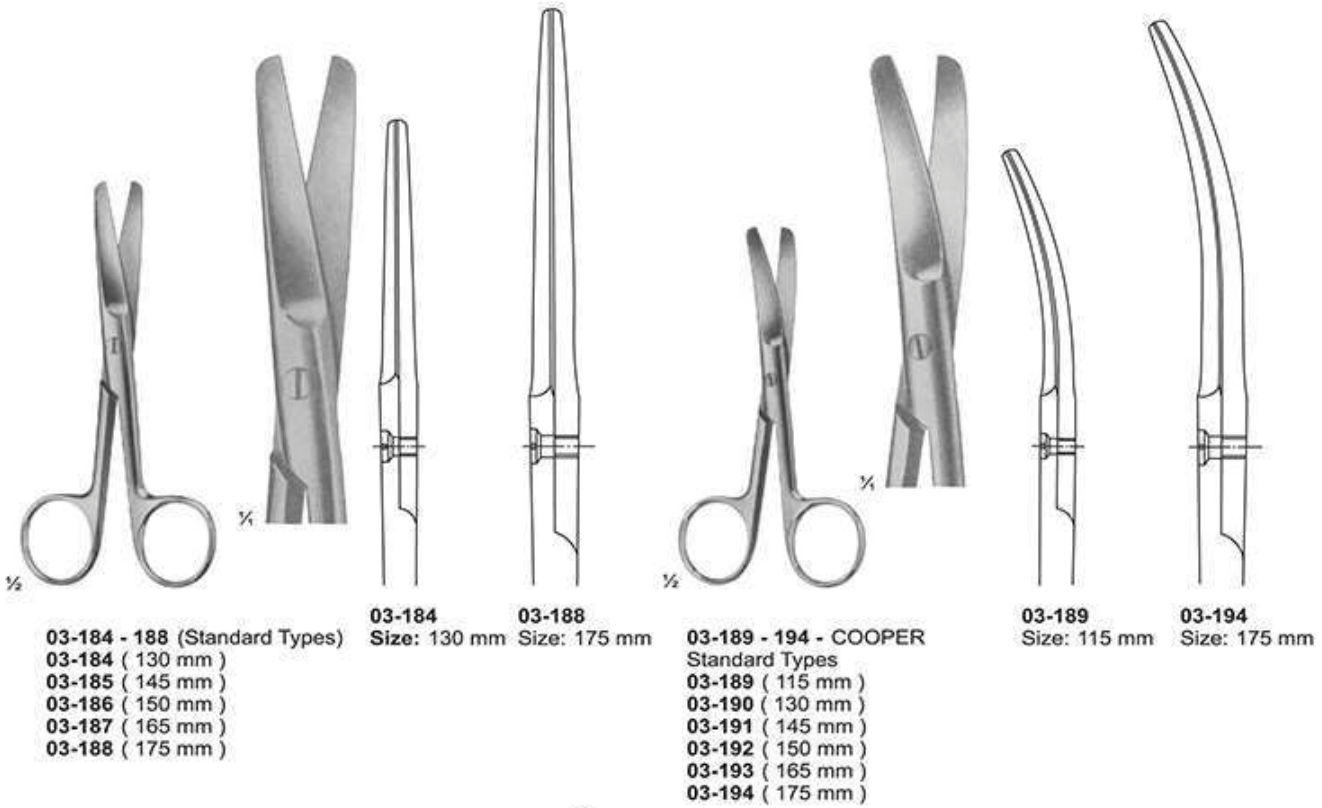

Surgical Scissors

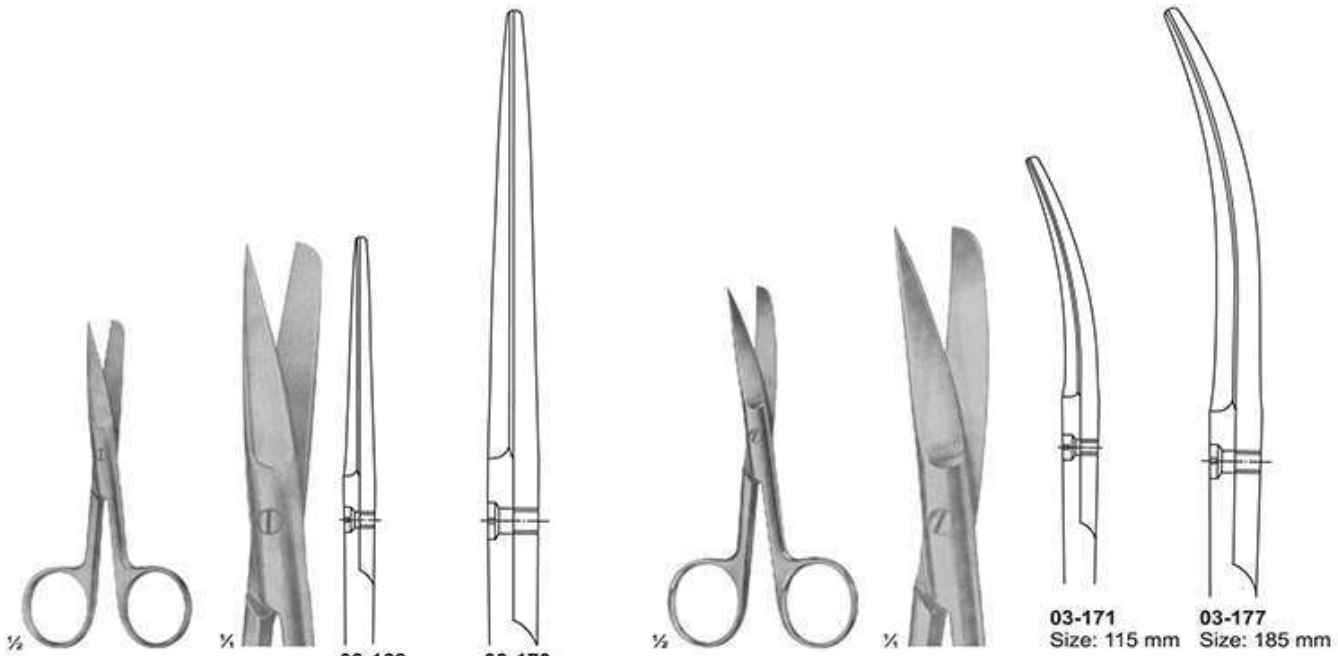

03-162 - 170 (Standard Types)
 03-162 (105 mm)
 03-163 (115 mm)
 03-164 (130 mm)
 03-165 (145 mm)
 03-166 (150 mm)
 03-167 (165 mm)
 03-168 (175 mm)
 03-169 (185 mm)
 03-170 (200 mm)

03-171 - 177 (Standard Types)
 03-171 (115 mm)
 03-172 (130 mm)
 03-173 (145 mm)
 03-174 (150 mm)
 03-175 (165 mm)
 03-176 (175 mm)
 03-177 (185 mm)

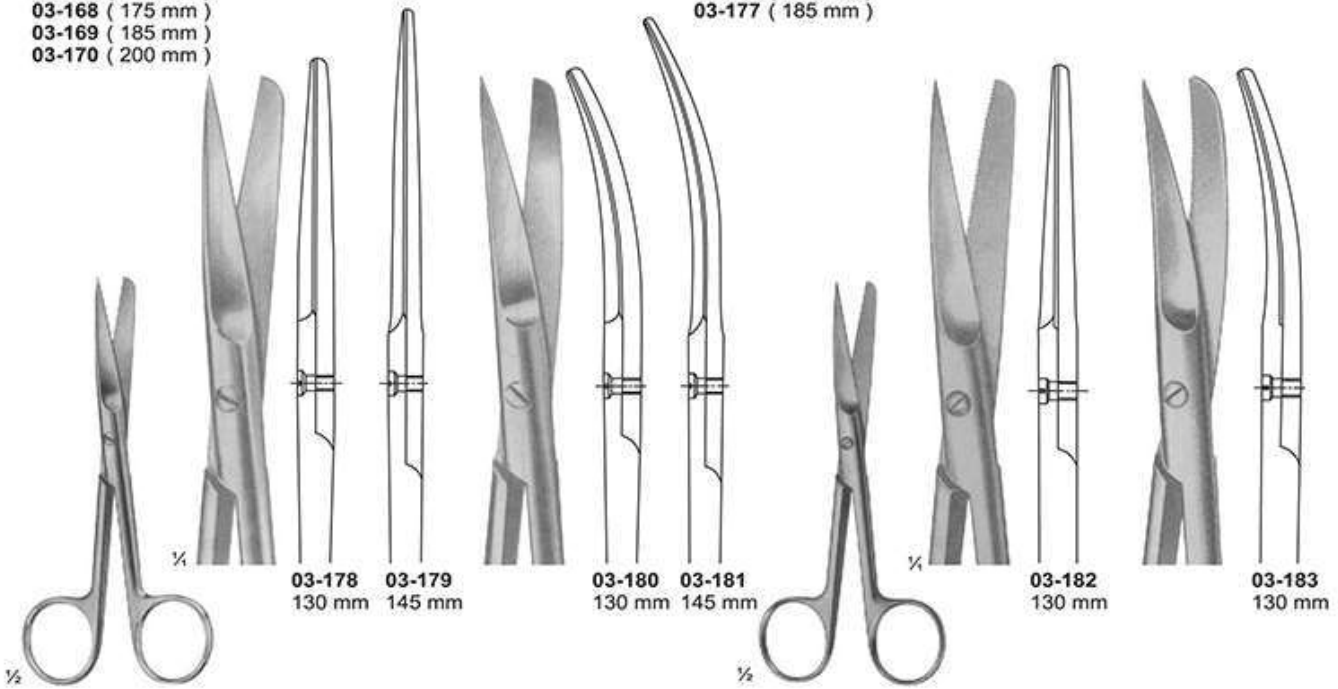

03-178 - 181
Slender Types

03-182 - 183
For Wound Edges
1 Blade Serrated

Delicate Scissors

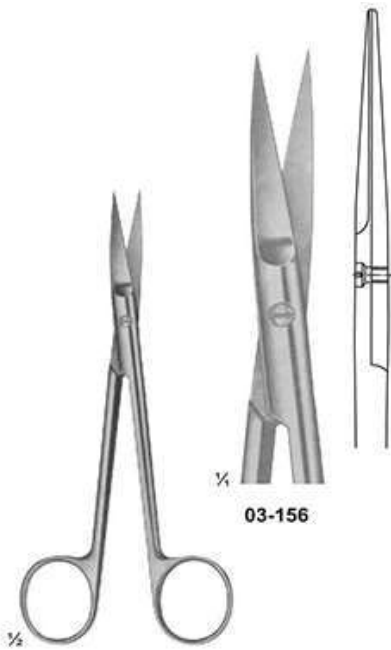

03-156



03-157

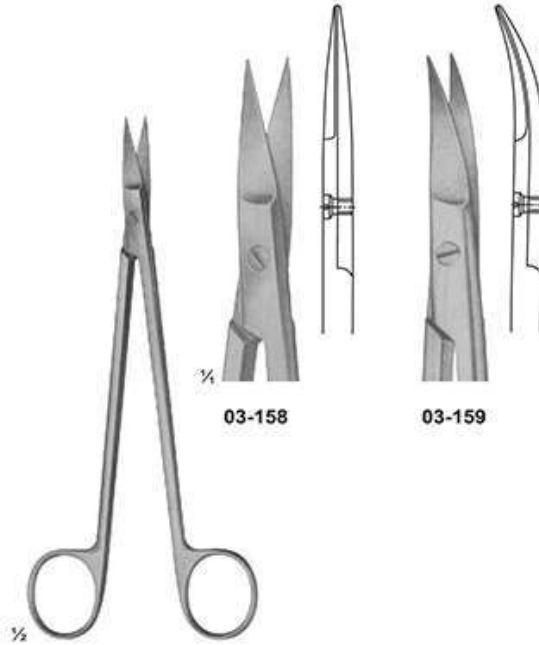

03-158

03-159

03-156 - 157
JOSEPH
Size: 150 mm

03-158 - 159
KELLY
Size: 175 mm

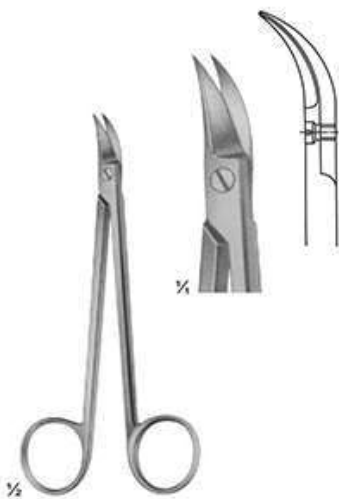

03-160
QUINBY
Size: 130 mm

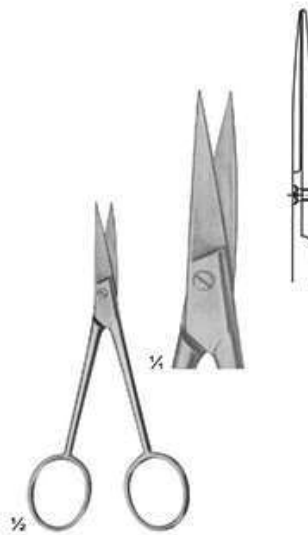

03-161
Size: 110 mm

Delicate Scissors

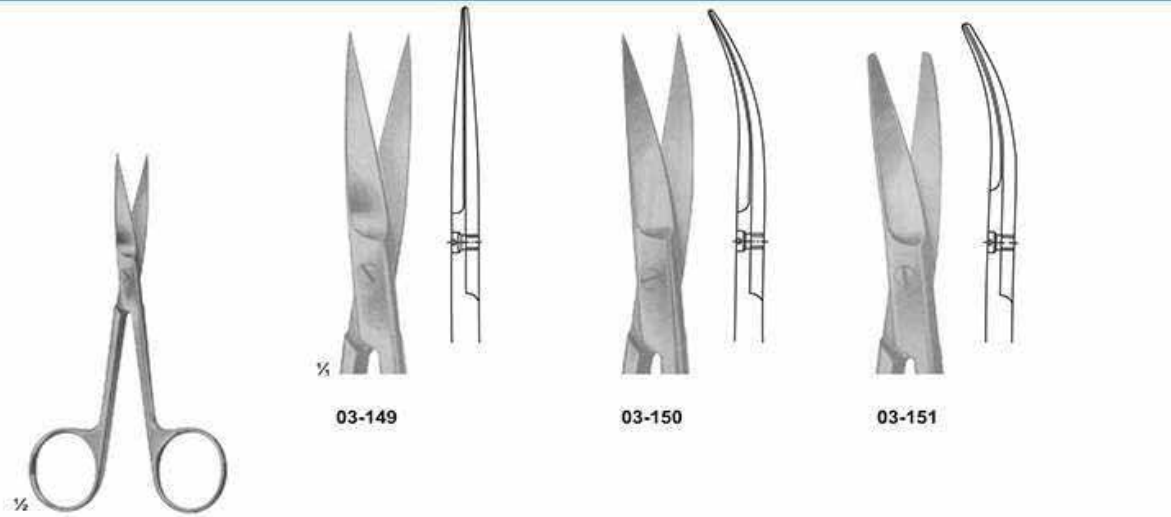

03-149 - 151
Size: 120 mm

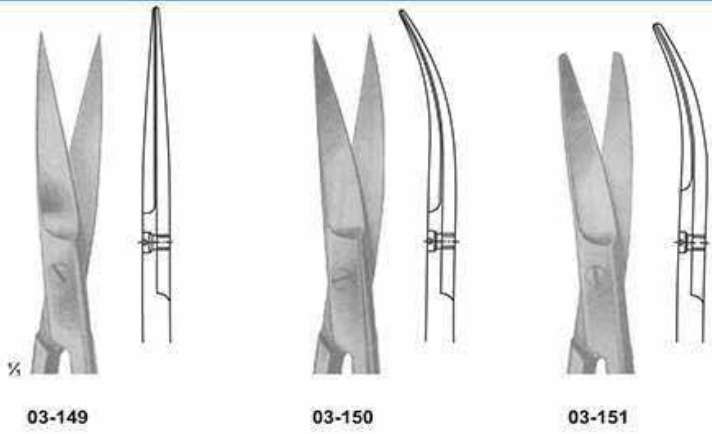

03-149

03-150

03-151

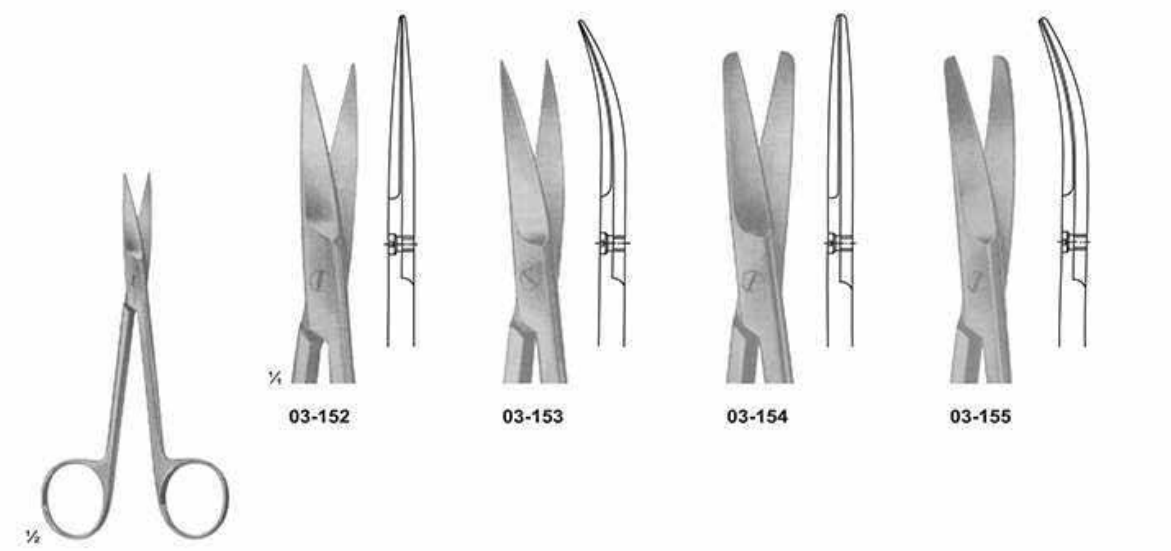

03-152 - 155
Size: 130 mm

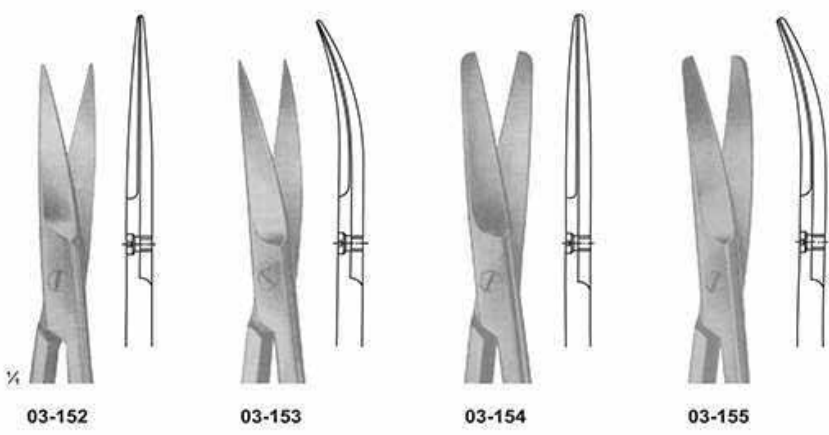

03-152

03-153

03-154

03-155

Delicate Scissors

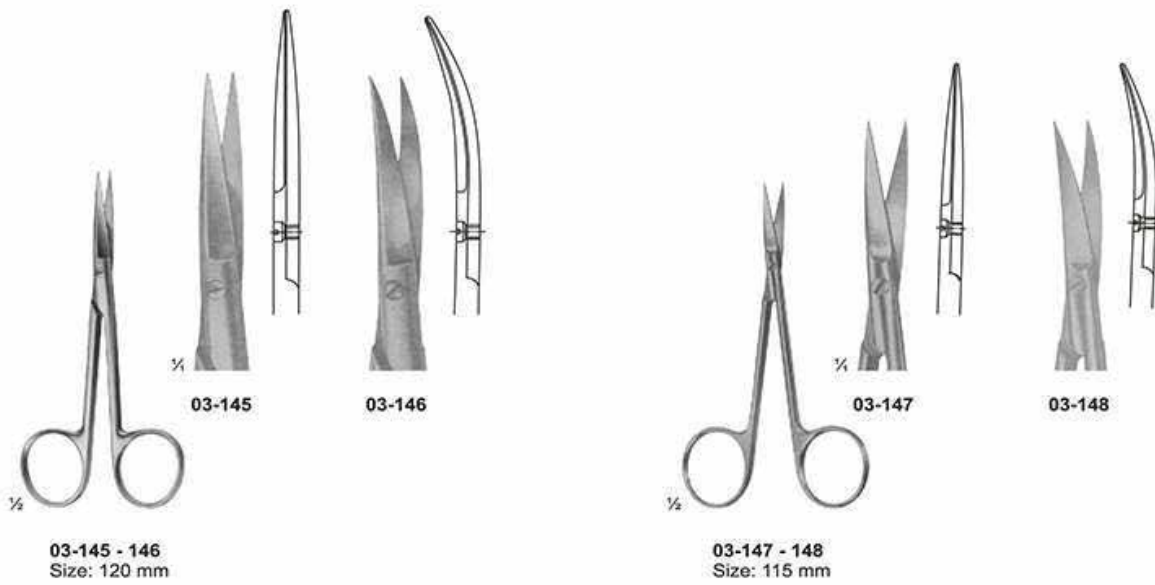

Delicate Scissors

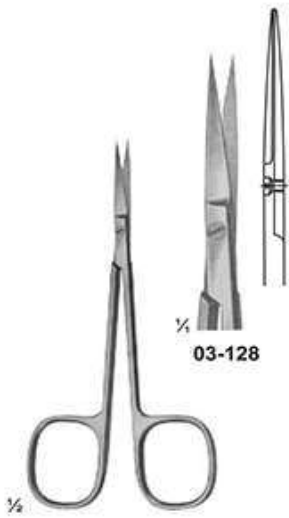

03-128



03-129

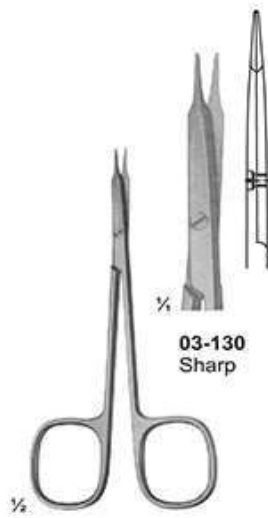

03-130
Sharp



03-131
Sharp



03-132
Blunt



03-133
Blunt

03-128 - 129
Size: 120 mm

03-130 - 133
STEVENS
Dissecting Scissors
Size: 115 mm

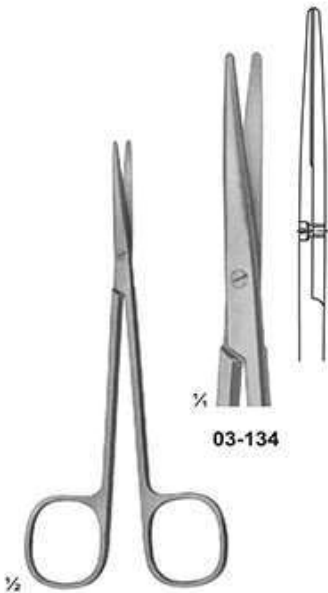

03-134



03-135

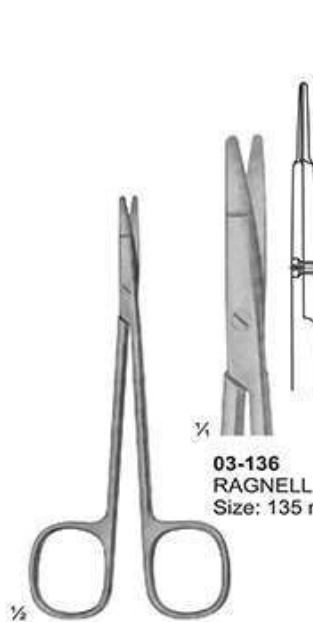

03-136
RAGNELL
Size: 135 mm

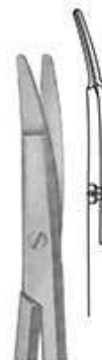

03-137
RAGNELL
Size: 135 mm



03-138
Size: 150 mm

03-134 - 135
METZENBAUM
Dissecting Scissors
Size: 145 mm

03-136 - 138
Special flat points for
dissecting and
undermining the skin
Size: 145 mm

Micro Scissors, "Spring Type" Bayonet Shape



03-122
YASARGIL
Size: 245 mm

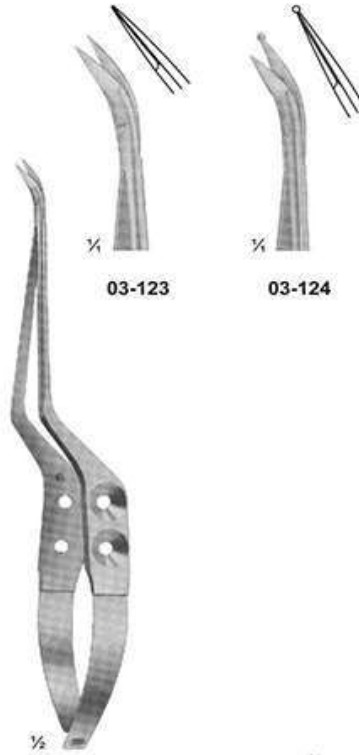

03-123 - 124
Laterally Angled
Size: 200 mm



03-125
Laterally Angled
Size: 190 mm

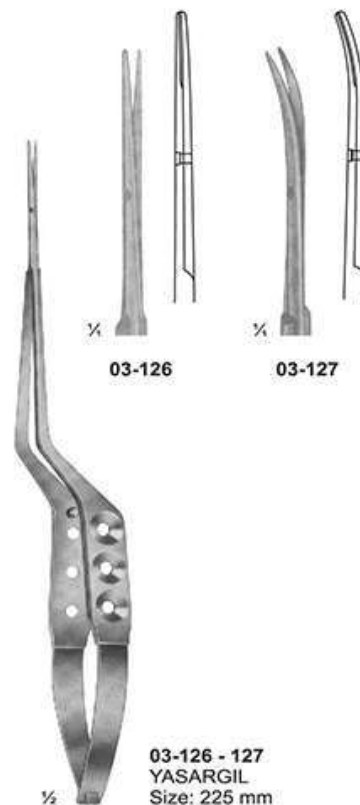

03-126 - 127
YASARGIL
Size: 225 mm

Micro Scissors, "Spring Type" Flat Handles

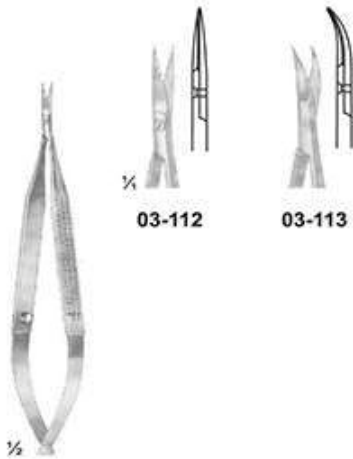

03-112 - 113
Size: 120 mm



03-114
BIEMER
Vein Scissor
Size: 130 mm

03-115
Size: 160 mm

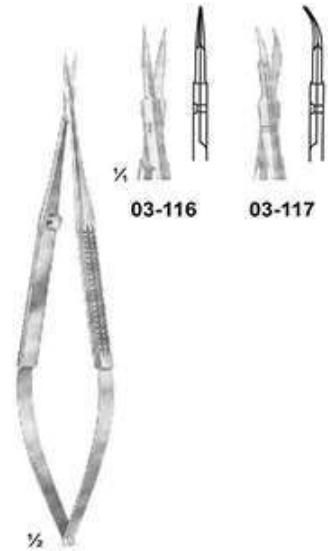

03-116 - 117
VANNAS
Size: 160 mm

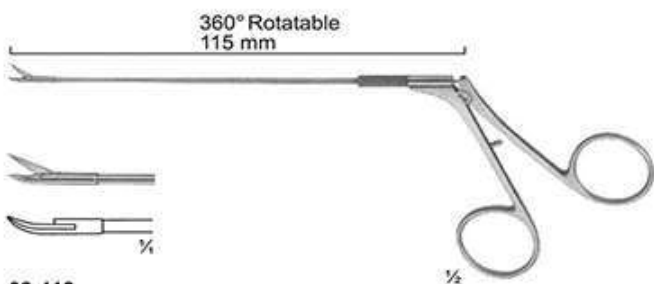

03-118
CASPAR
Micro Scissor Curved
Size: 115 mm

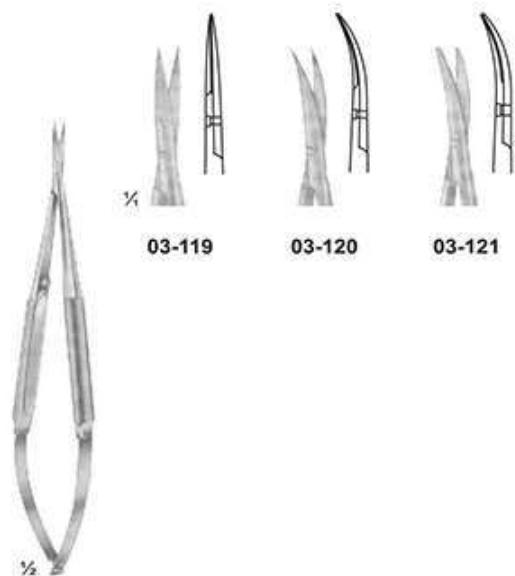

03-119 - 121
Micro Dissecting Scissor
Size: 145 mm

Micro Scissors, "Spring Type" Flat Handles

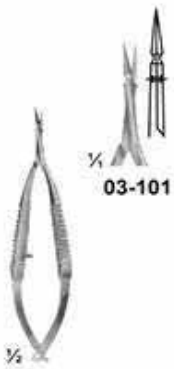

03-101 - 103
VANNAS
Size: 85 mm



03-101



03-102



03-103

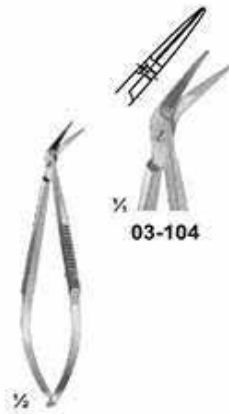

03-104 - 105
CASTROVIEJO
Size: 95 mm



03-104



03-105

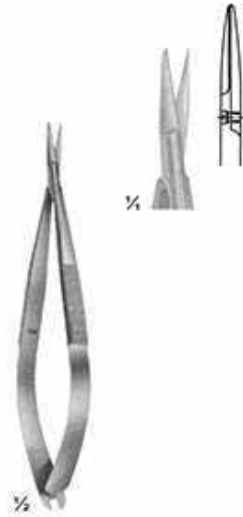

03-106
NOYES
Size: 125 mm



03-106



03-107 - 108
WECKER
Eye Scissor
Size: 110 mm



03-107



03-108



03-109
CASTROVIEJO
Eye Scissor
Size: 115 mm



03-109

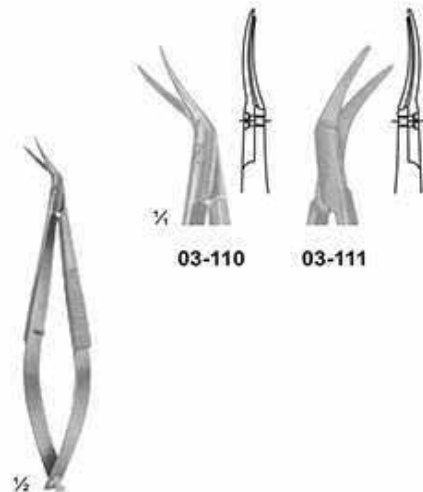

03-110 - 111
CASTROVIEJO
Eye Scissor
Size: 110 mm



03-110



03-111

Scalpel Handles

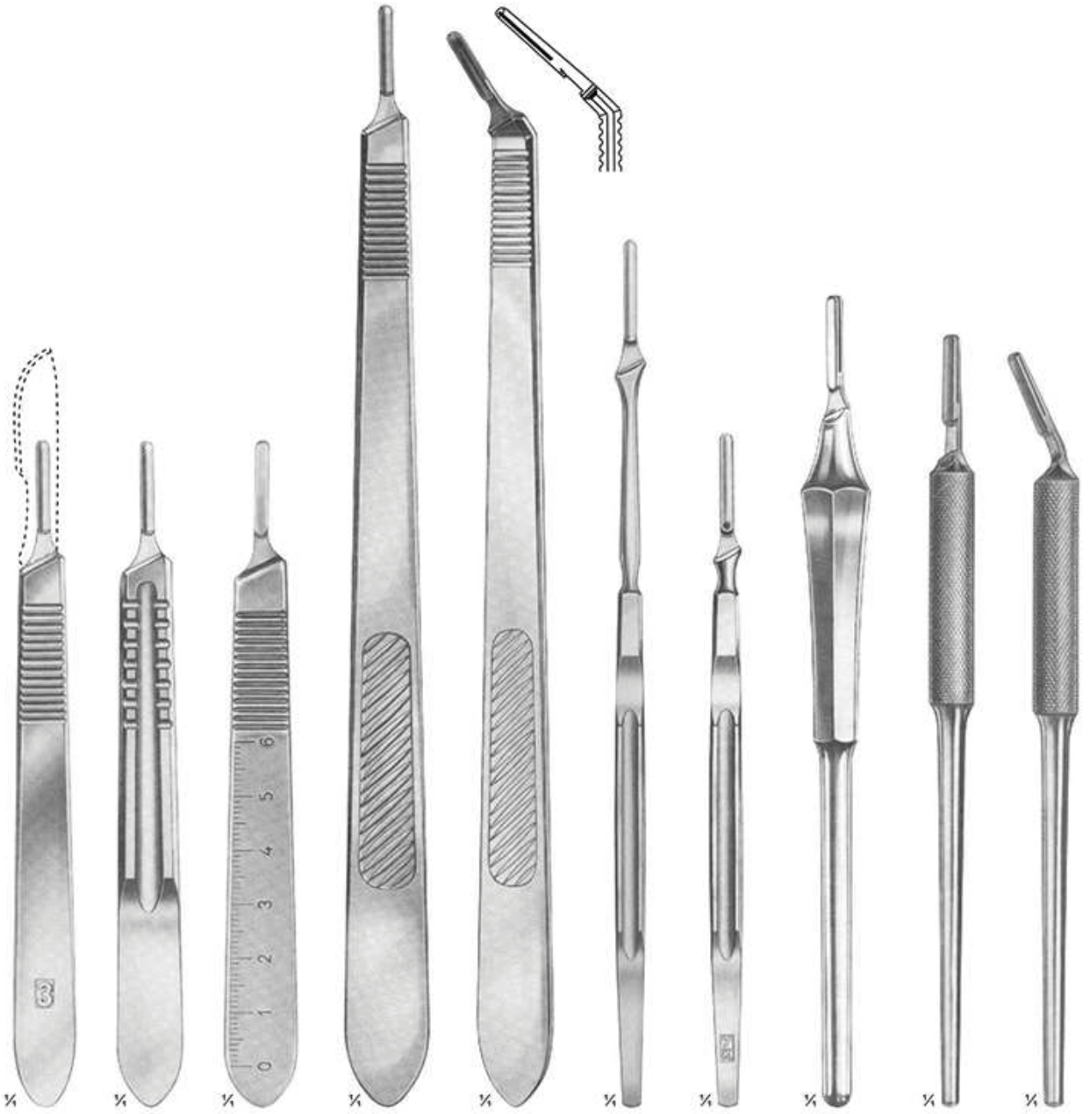

02-192 STANDARD No. 3 Solid	02-193 No. 3 Solid	02-194 No. 3 Solid	02-195 No. 3 L Straight Solid	02-196 No. 3 L Angled Solid	02-197 No. 7 Solid	02-198 No. 7 K Solid	02-199 Hollow-Round	02-200 No. 3 Straight Solid	02-201 No. 3 Angled Solid
---	---------------------------------	---------------------------------	---	---	---------------------------------	-----------------------------------	-------------------------------	---	---

Scalpel Handles

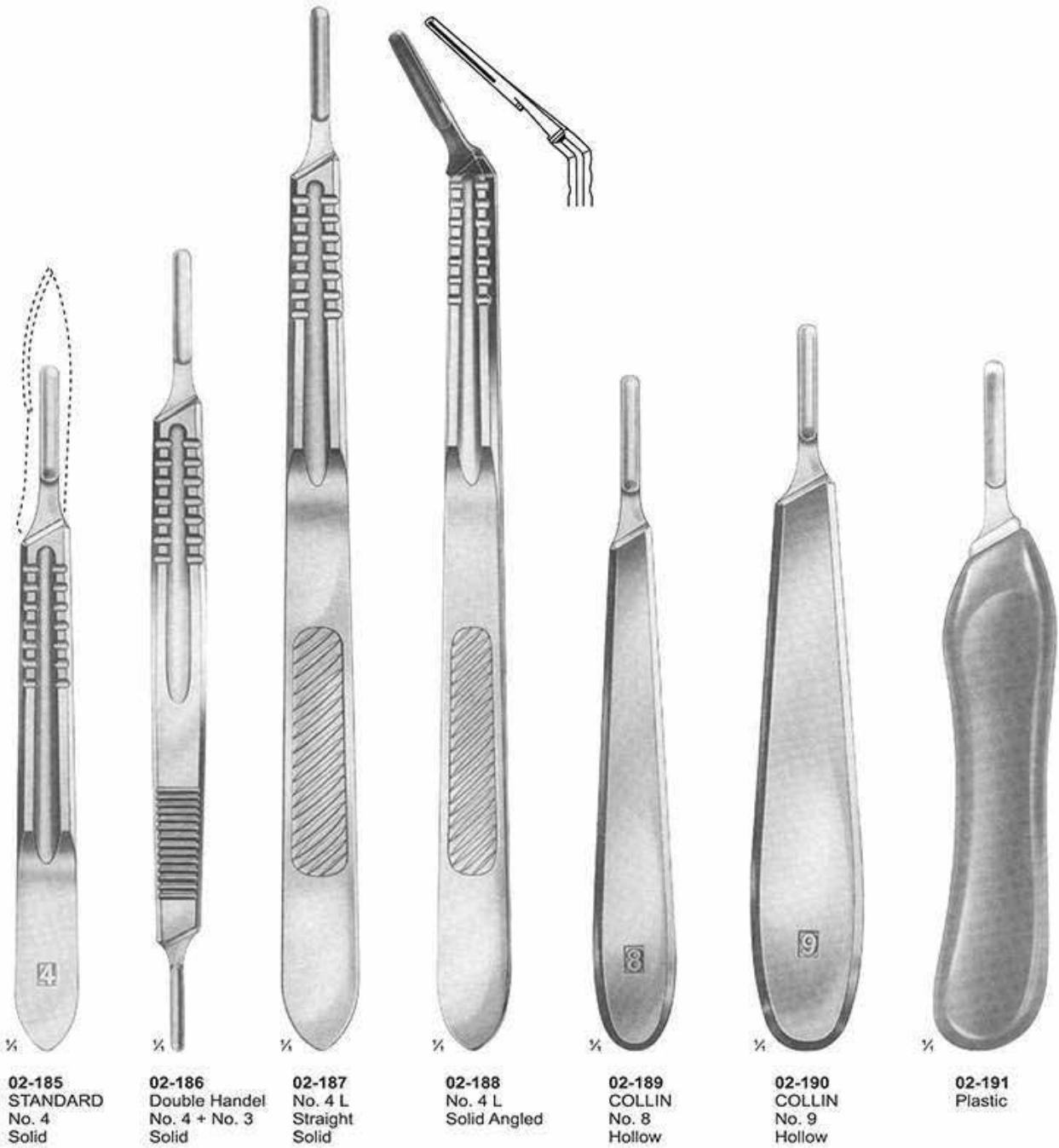

Razor Blade Holders & Breakers



02-180
TROUTMAN-CHRIS
Size: 100 mm



02-181
TROUTMAN-CHRIS
Size: 100 mm



02-182
Size: 110 mm



02-183
CASTROVIEJO
Size: 130 mm



02-184
Size: 185 mm

Scalpels, Dura Knives & Comedone Extractors

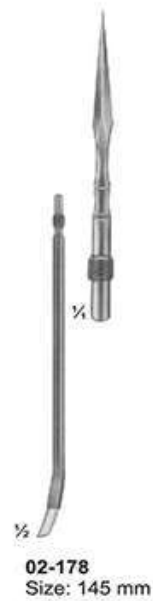
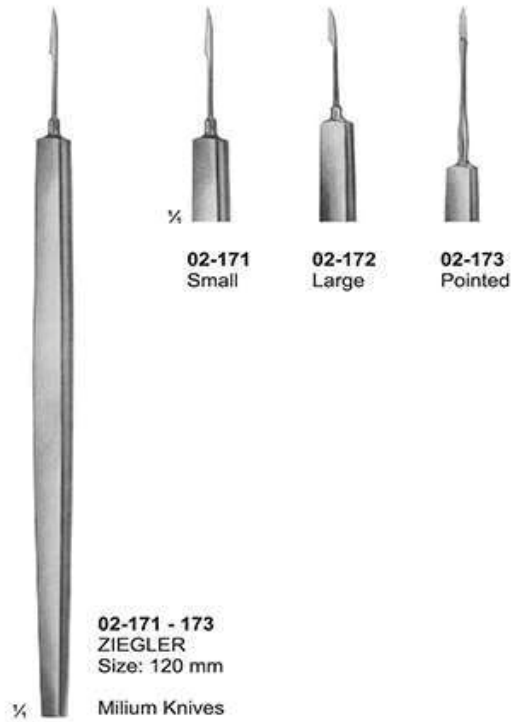
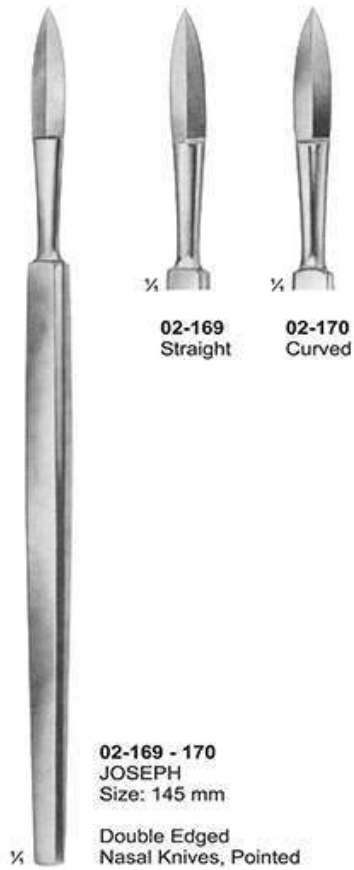

Cone Knives, Myomatome, Trigeminal & Tonsil Knives



Amputating Knives, Cartilage Knives, Autopsy Knives



02-150
Size: 130 mm
02-151
Size: 160 mm
02-152
Size: 190 mm
02-153
Size: 200 mm

Blade Length
Amputating Knives

02-154
CATLIN
Size: 160 mm
Blade Length
Amputating
Knives

02-155
LANGENBECK
Size: 120 mm
Blade Length
Flap Knives

02-156
Size: 110 mm
Blade Length
Interosseous
Knives

02-157
Size: 55 mm
Blade Length
With Raspatory,
Wooden Handle

02-158
Size: 70 mm
Blade Length
Wooden Handle

02-159
Size: 80 mm
Blade Length
Metal Handle

02-160
Size: 195 mm
Blade Length
Metal Handle

Scalpels, Tenotomes

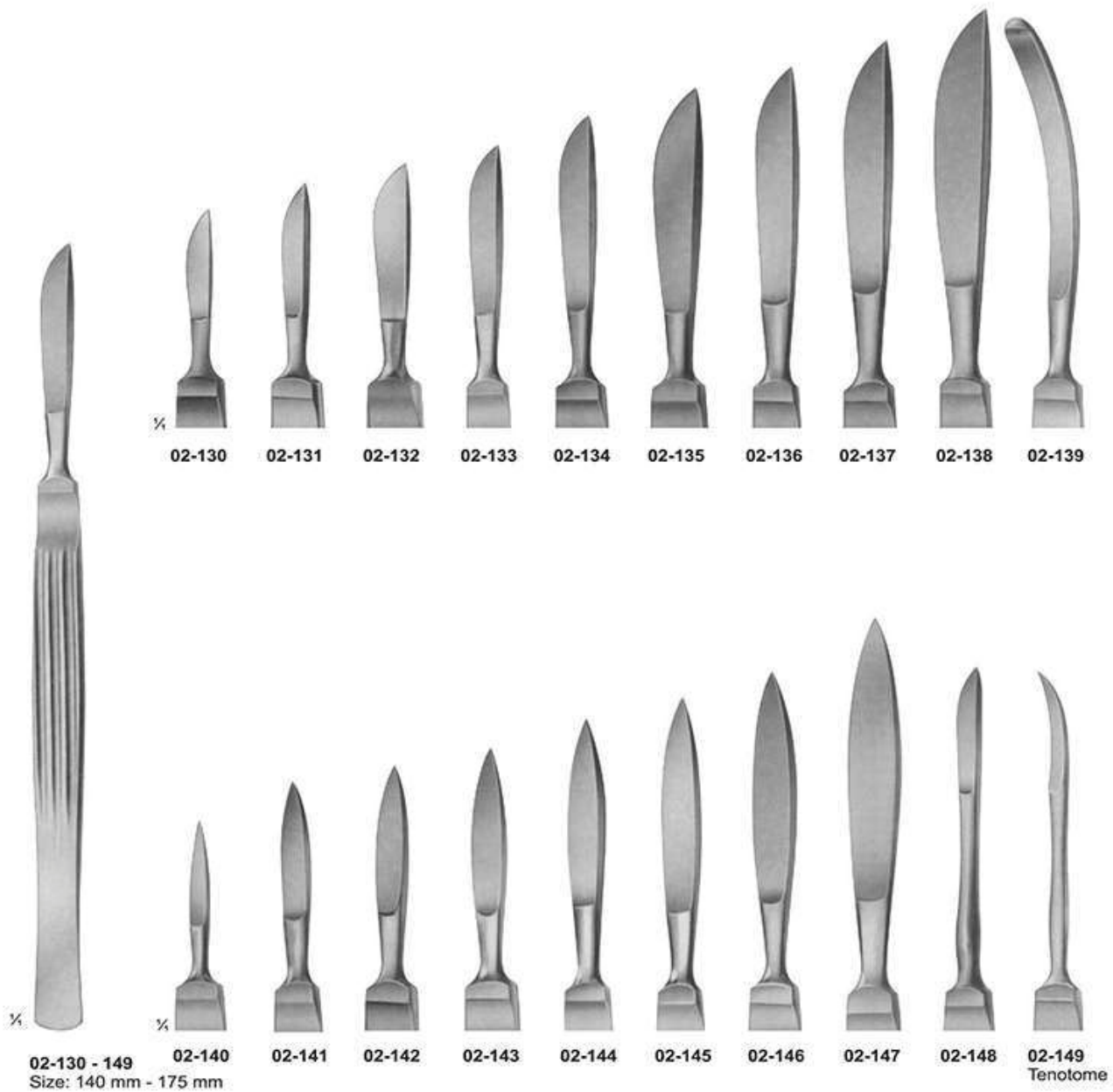

02-130 02-131 02-132 02-133 02-134 02-135 02-136 02-137 02-138 02-139

02-130 - 149 Size: 140 mm - 175 mm 02-140 02-141 02-142 02-143 02-144 02-145 02-146 02-147 02-148 02-149 Tenotome

Scalpels, Tenotomes & Resection Knives

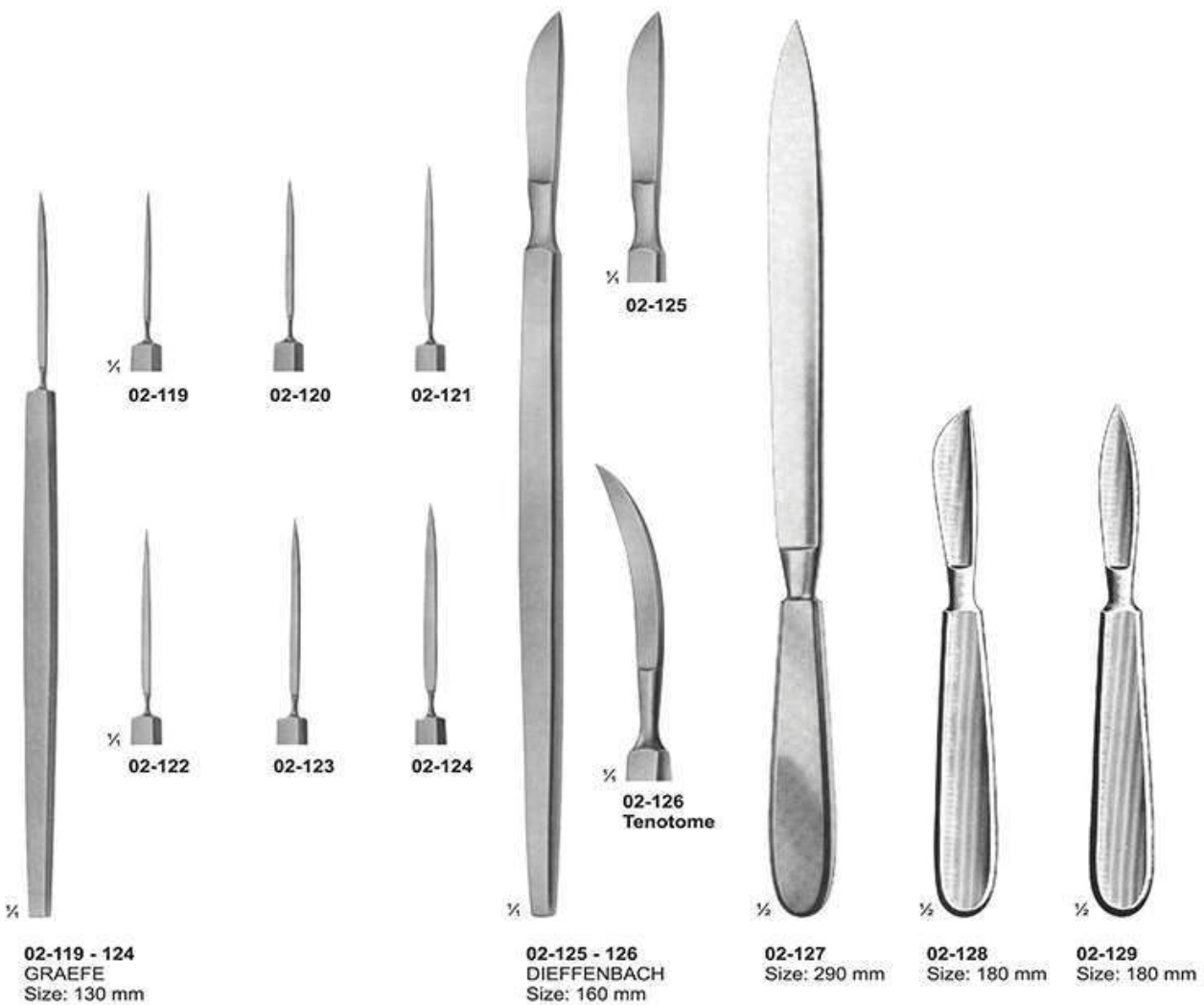

Autopsy & Cartilage Knives

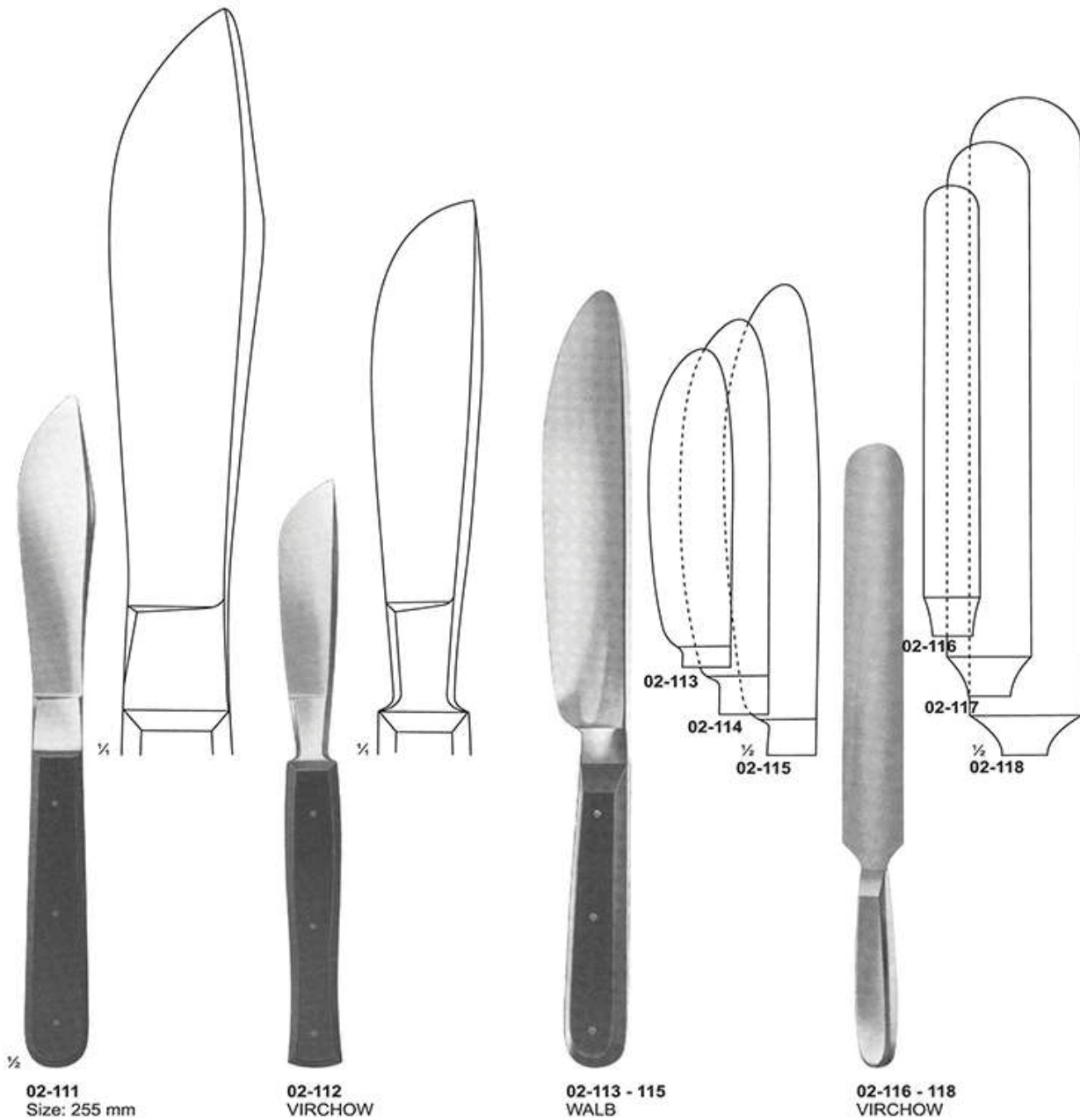

Dissecting Knives

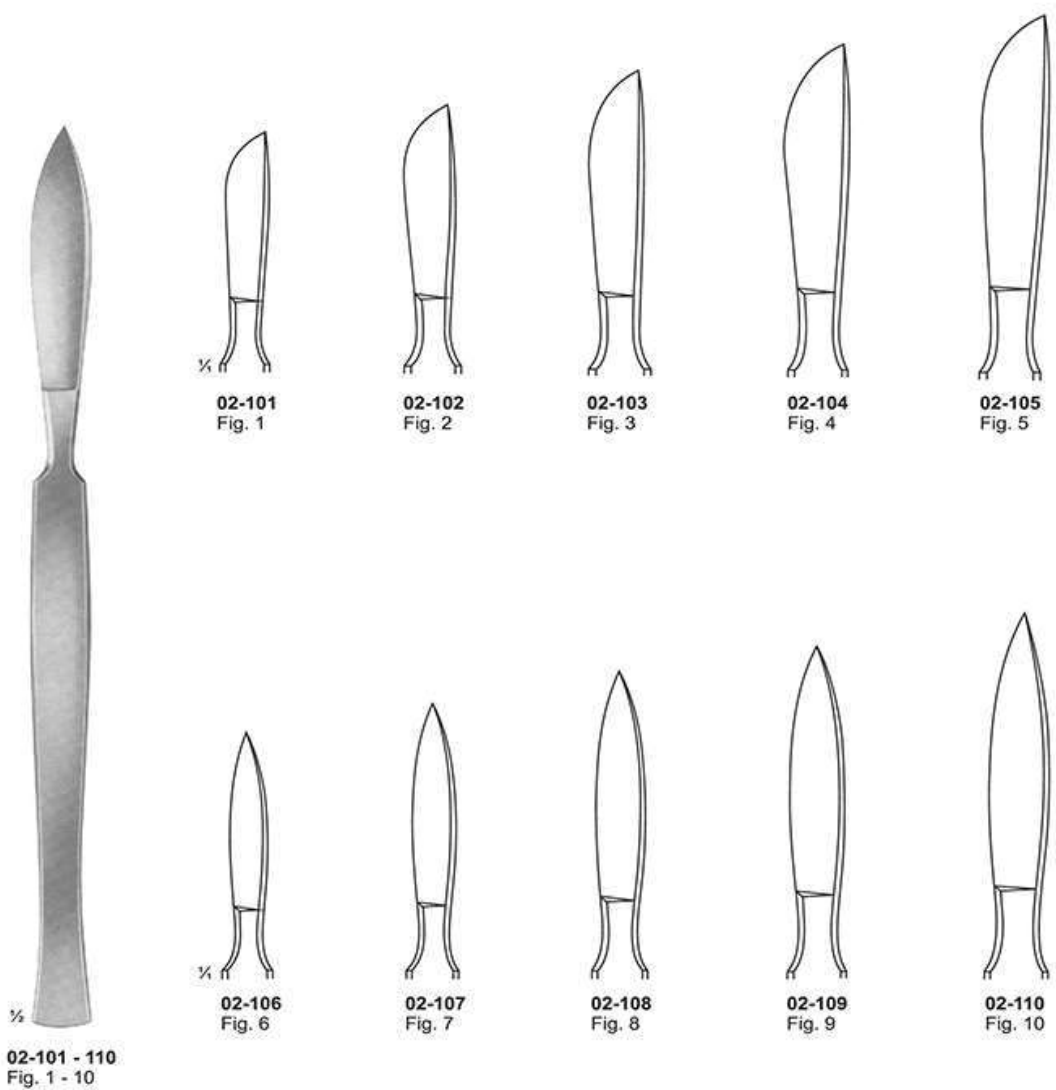

Examination & Measuring Instruments



01-176
Caliper Of Aluminum
Up To 180 mm



01-177
VERNIER
Universal Caliper Of Steel
Up To 120 mm



01-178
CAROLL
Size: 140 mm



01-179
TOWNLEY
Size: 100 mm



01-180
COLLIN
Druck Pressure 72 kg
Size: 125 mm



01-181
BERTILLON
Caliper For Measuring The Head
Size: 320 mm



01-182
CASTROVIEJO
Caliper



01-183
MOLTGEN
Goniometer



01-184
Size: 500 mm



01-185
Size: 150 mm

Diagnostic Sets



01-168
McIntosh
Laryngoscope Set, Consists Of Battery Handle (Without Battery)
With Three McIntosh Blades, Fig. 1, Fig. 2, Fig. 3

01-169
McIntosh
Laryngoscope Set, Consists Of Battery Handle (Without Battery)
With Five McIntosh Blades, Fig. 1, Fig. 2, Fig. 3, Fig. 4, Fig. 5

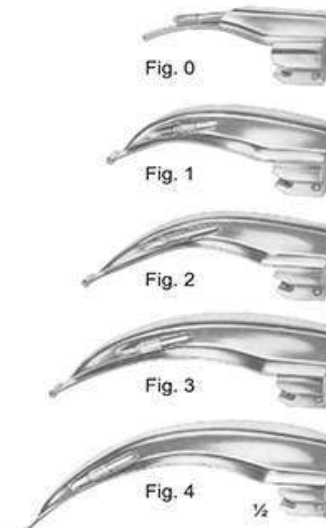

Fig. 0 Working Length, 55 mm (Baby's)
Fig. 1 Working Length, 75 mm (Children's)
Fig. 2 Working Length, 90 mm (Adolescent's)
Fig. 3 Working Length, 110 mm (Women's)
Fig. 4 Working Length, 135 mm (Men's)



01-170
FOREGGER
Laryngoscope Set, Consists Of
Battery Handle (Without Battery)
With Three Foregger Blades,
Fig. 1, Fig. 2, Fig. 3,

01-171
FOREGGER
Laryngoscope Set, Consists Of
Battery Handle (Without Battery)
With Five Foregger Blades,
Fig. 1, Fig. 2, Fig. 3, Fig. 4, Fig. 5

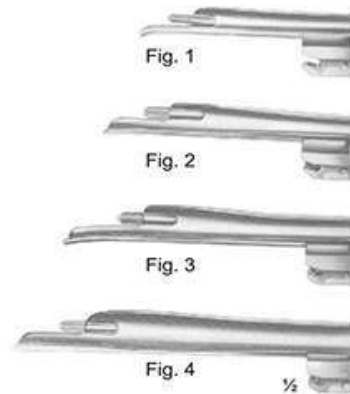

Fig. 1 Working Length, 70 mm (Children's)
Fig. 2 Working Length, 90 mm (Adolescent's)
Fig. 3 Working Length, 110 mm (Women's)
Fig. 4 Working Length, 135 mm (Men's)



01-172
Fiber Optic
Battery Handle



01-173
Fiber Optic
Battery Handle



01-174
Replacement Lamp
(Krypton) 2.5 V



01-175
Replacement Lamp
(Halogen) 2.5 V

Diagnostic Sets



01-166
MILLER
Laryngoscope Set, Consists Of Battery Handle (Without Battery)
With Four Miller Laryngoscope Blades

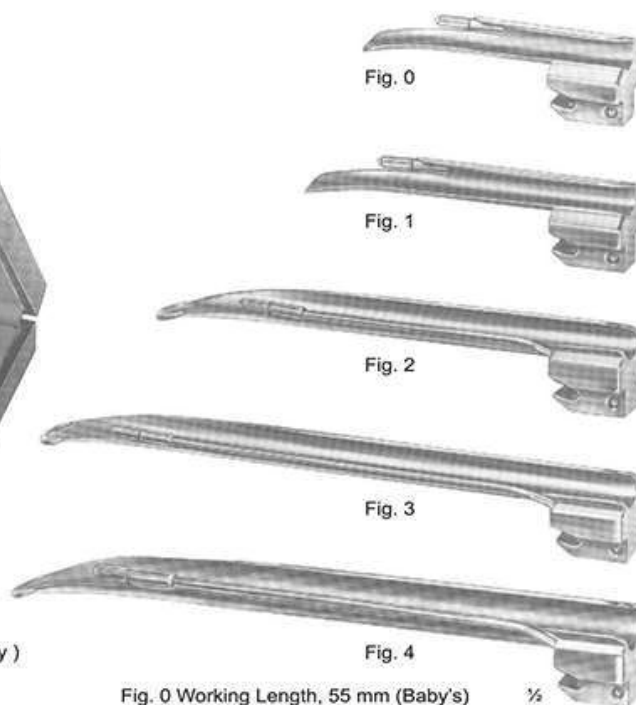

Fig. 0 Working Length, 55 mm (Baby's) $\frac{1}{4}$
Fig. 1 Working Length, 80 mm (Children's)
Fig. 2 Working Length, 130 mm (Adolescent's)
Fig. 3 Working Length, 170 mm (Women's)
Fig. 4 Working Length, 180 mm (Men's)



01-167
GUEDEL-NEGUS
Laryngoscope Set, Consists Of Battery Handle (Without Battery)
With Four Miller Laryngoscope Blades

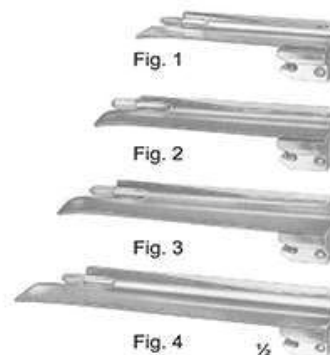

Fig. 1 Working Length, 70 mm (Children's)
Fig. 2 Working Length, 90 mm (Adolescent's)
Fig. 3 Working Length, 110 mm (Women's)
Fig. 4 Working Length, 135 mm (Men's)

Diagnostic Sets



1/2
01-160 - 162
MAGILL



1/4
01-160
Infants
Size: 150 mm



1/4
01-161
Children
Size: 200 mm



1/4
01-162
Adults
Size: 250 mm



1/2
01-163
Medium battery handle
only, 25 mm diam.



01-163-A
Spare bulb
2.7 volt, for
otoscopes



01-163-B
Spare bulb
2.6 volt, for
ophthalmoscopes



01-164
Otoscope Set, Consists Of
Battery Handle Without Batteries,
3 Ear Specula, 1 Bulb In Velvet Lined Case



01-165
Diagnostic Set, Otoscope With Three Specula,
Nasal Speculum, Lamp Holder, Two Laryngeal
Mirrors, Tongue Blade Holder

Blood Lancets & Laryngeal Mirrors

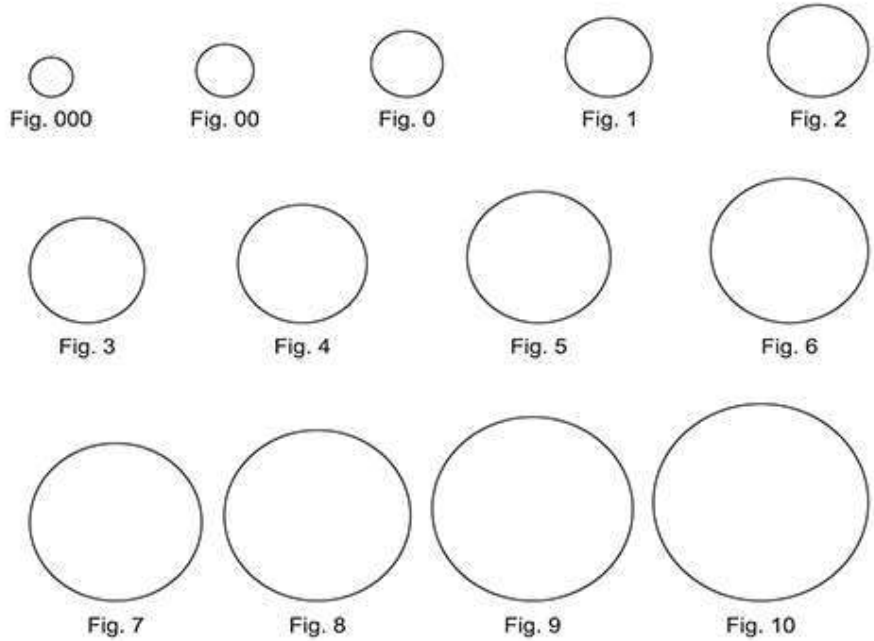

Tongue Depressors



01-144
SCHIMMELBUSCH
Ether Mask



01-145
HEISTER
Mouth Gag
Size: 130 mm



01-146
FERGUSON-ACKLAND
Mouth Gag
Size: 145 mm



01-147
DENHARDT
Mouth Gag With Silicon
Inserts, Interchangeable
Size: 125 mm



01-148
ROSER KONIG
Mouth Gag
Size: 160 mm, 185 mm



01-149
YOUNG
Size: 165 mm

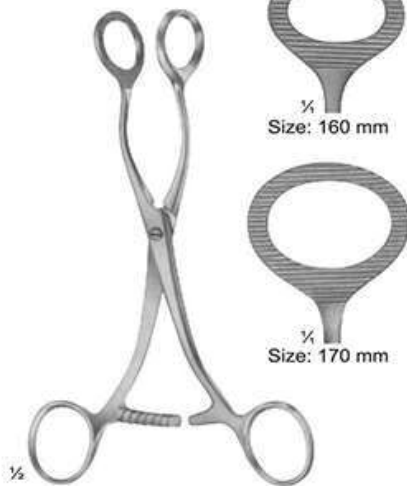

01-150
COLLIN
Size: 160 mm, 170 mm

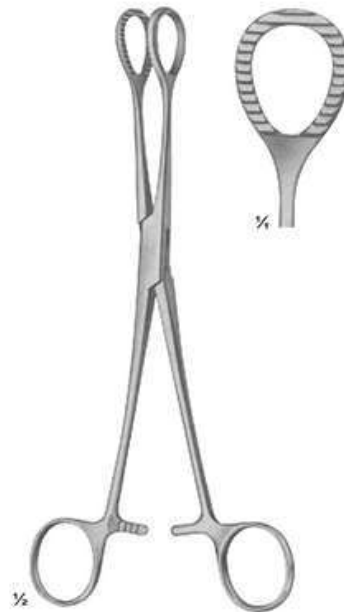

01-151
HEYWOOD-SMITH modif.
Size: 215 mm

Tongue Depressors

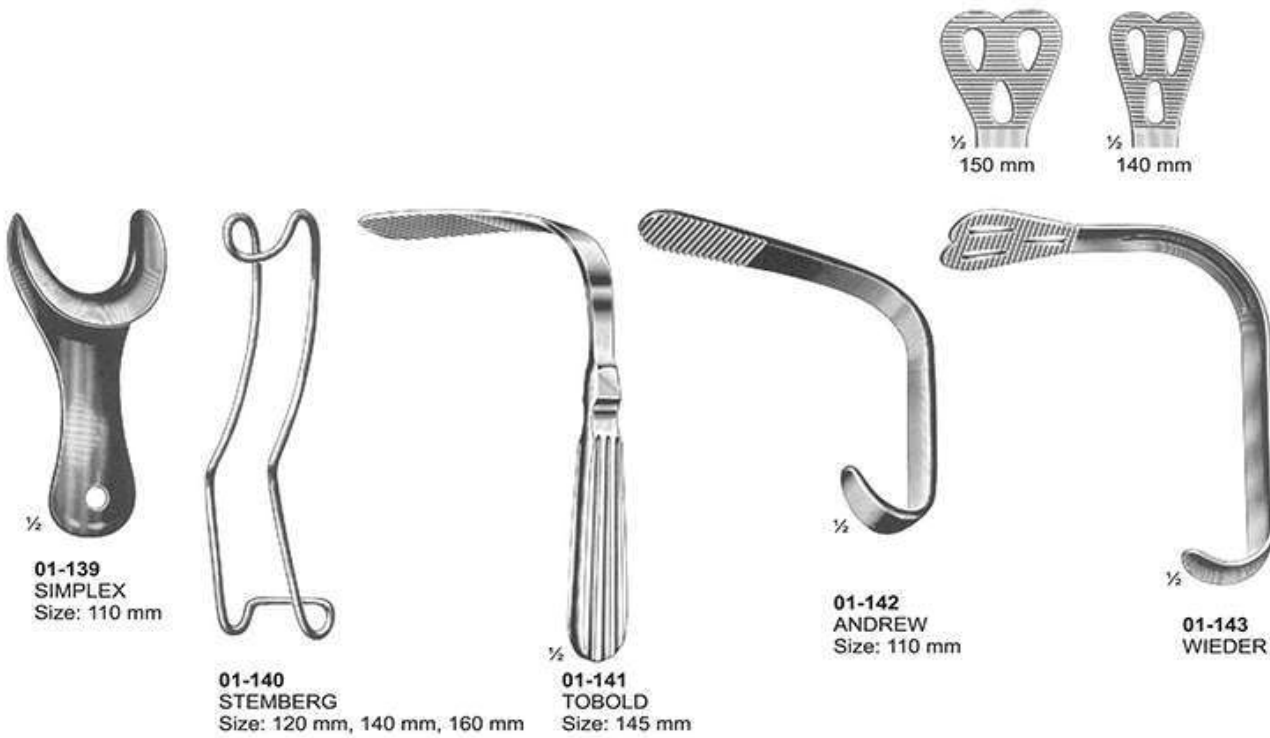
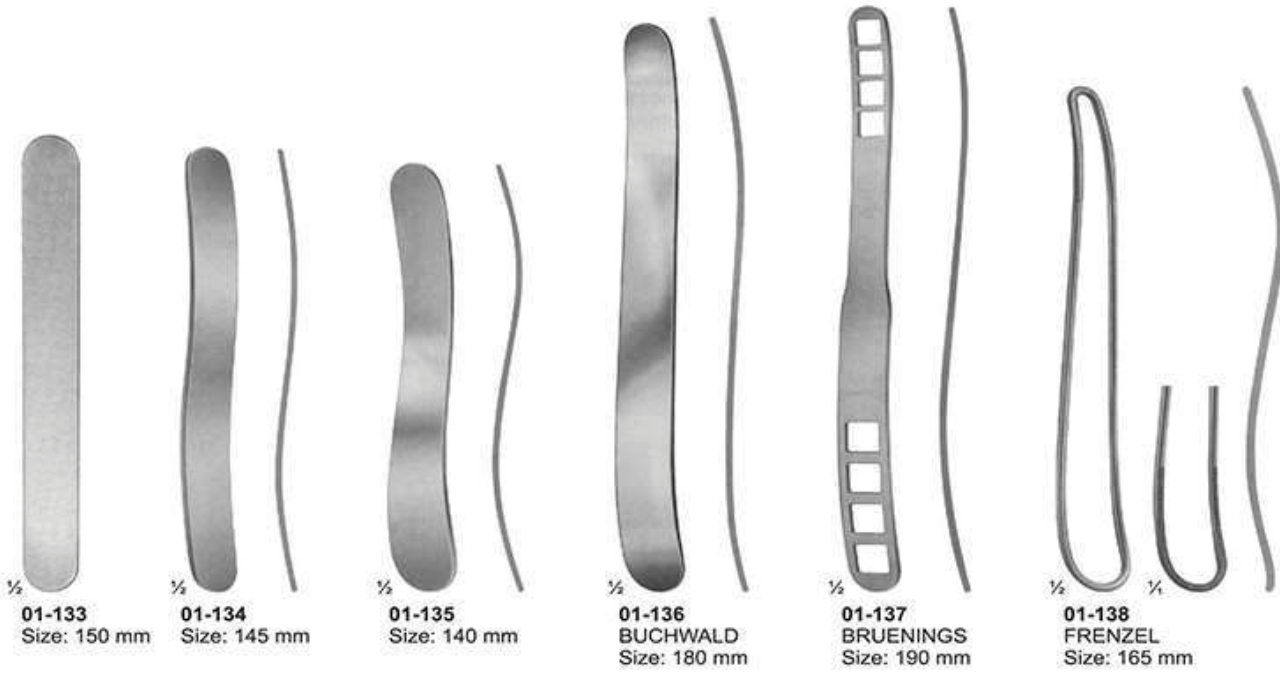

Stethoscopes



01-110
PINARD (Aluminum)
Size: 155 mm



01-111
aus Holz (Wooden)
Size: 145 mm



01-112
BOWLES
Stethoscope
With Diaphragm



01-113
ANESTOPHON



01-114
FORD-BOWLES
Duel Chest Piece
With Two Outlets



01-115
BOWLES

Percussion Hammers & Aesthesiometers

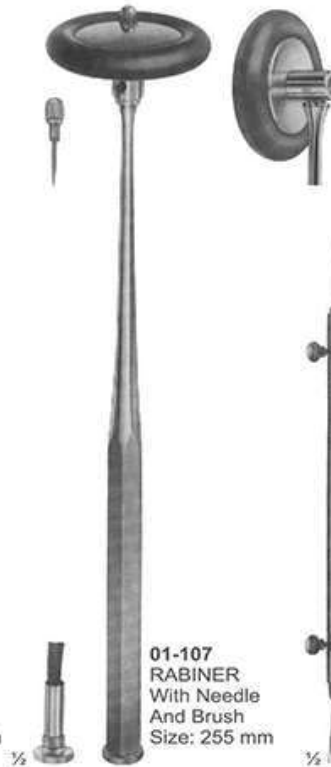
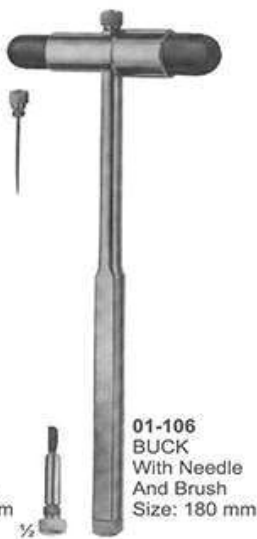

Instruments For Trumatology

397.700'
Handle with quick coupling
length 150mm

397.710'
Cancellous Bone Impactor, curved, 6mm dia.
Length 140mm

397.720'
Cancellous Bone Impactor, curved, 6mm dia. flattened
Length 140mm

397.730'
Cancellous Bone Impactor, straight, 8mm dia.
Length 140mm

397.740'
Cancellous Bone Impactor,
rectangular, 6x16mm
Length 140mm

397.750'
Cancellous Bone Impactor, rectangular,
10x20mm Length 140mm

397.760'
Cancellous Bone Impactor,
rectangular, 10x30mm
Length 140mm

397.790
Rasp, round
Length 140mm

397.800
Rasp, half-round
length 140mm

397.810
Gouge, straight, 5mm wide
length 140mm

397.850
Gouge, curved, 5mm wide
length 140mm

397.820
Gouge, straight,
10mm wide
length 140mm

397.860'
Gouge, curved, 10mm wide
length 140mm

397.870'
Gouge, curved, 15mm wide
length 140mm

397.830
Gouge, straight, 15mm wide
length 140mm

397.910'
Gouge, flat, straight, 16mm wide
length 140mm

397.930
Chisel, flat, curved, 16mm wide
length 140mm

397.960
Chisel, flat, curved, 4mm wide
length 140mm

397.990
Chisel, flat, 20mm wide
length 140mm

397.970
Chisel, flat, curved, 8mm wide
length 140mm

Steinmann Pins
Implantable Material
25-100-00

Steinmann Pins are Available in Lengths
8 Inches
9 Inches
10 Inches
11 Inches
12 Inches

Diameter \varnothing
A: 3.2 mm
B: 3.6 mm
C: 4.0 mm
D: 4.5 mm
E: 4.7 mm
F: 5.0 mm
G: 6.0 mm

25-101-00
Circlage-Bone Wire Soft
Coil of 10 Meters
Implantable Material

Diameter \varnothing
A: 0.2 mm
B: 0.3 mm
C: 0.4 mm
D: 0.5 mm
E: 0.6 mm
F: 0.7 mm
G: 0.8 mm
H: 0.9 mm
I: 1.0 mm
J: 1.2 mm
K: 1.5 mm
M: 1.7 mm

25-102-00 Shanz Screws
Implantable Material

2 x 60 x 15 mm	5 x 150 x 30 mm
3 x 60 x 15 mm	5 x 160 x 40 mm
3 x 80 x 15 mm	5 x 180 x 40 mm
3 x 80 x 20 mm	5 x 200 x 40 mm
3 x 100 x 15 mm	5 x 220 x 40 mm
3 x 120 x 15 mm	6 x 120 x 40 mm
4 x 80 x 20 mm	6 x 140 x 40 mm
4 x 100 x 20 mm	6 x 150 x 40 mm
4 x 120 x 20 mm	6 x 160 x 40 mm
4 x 140 x 20 mm	6 x 180 x 40 mm
5 x 120 x 30 mm	6 x 200 x 40 mm
5 x 140 x 30 mm	6 x 220 x 40 mm

Dia X Total Length X Thread Length

Kirschner Wire
Implantable Material
25-103-00

Packs of 10 units	St. steel	Diameter	Length
	292.060	0.60mm	070mm
	292.080	0.80mm	070mm
	292.090	0.80mm	150mm
	292.100	1.00mm	150mm
	292.110	1.00mm	280mm
	292.120	1.25mm	150mm
	292.130	1.25mm	280mm
	292.140	1.40mm	150mm
	292.150	1.40mm	280mm
	292.160	1.60mm	150mm
	292.170	1.80mm	150mm
	292.180	1.60mm	280mm

Kirschner Wire
Implantable Material
25-103-00

Packs of 10 units	St. steel	Diameter	Length
	292.190	1.80mm	280mm
	292.200	2.00mm	150mm
	292.210	2.00mm	280mm
	292.230	2.00mm	400mm
	292.250	2.50mm	150mm
	292.260	2.50mm	280mm
	292.280	2.50mm	400mm
	292.300	3.00mm	150mm
	292.310	3.00mm	280mm
	292.330	3.00mm	400mm

Instruments For Trumatology



392.000¹
Bending Iron for Kirschner Wires
length 120mm, for 1.25 to 2.5mm dia.



392.020
Bending Iron for Kirschner Wires
length 115mm, for 0.8 to 1.25mm dia.



329.080
Bending Iron for Reconstruction Plates 3.5 and 4.5
length 190mm, required in pairs



397.110
Handle with Sleeve
with rotating drill guide and anchoring point



397.120
Trocar Point, large, for number 397.110
for nos. 387.000/397.110



397.130
Cheek Retractor Ring, for number 397.110
for nos. 387.000/397.110



321.160¹
Combination Wrench 11mm
length 140mm



321.170¹
Pin Wrench
length 120mm, 4.5mm dia.
For tension device, distractor and knurled
nut of insertion handle for intramedullary nail



321.150¹
Socket Wrench 11mm
length 200mm



332.200¹
Slotted Hammer
length 270mm



332.160¹
Inserter/Extractor, with Adjustable Clamps
length 270mm, for the insertion and extraction of angled plates for
adults and hip plates for adolescents and children as well as tibial
plateau osteotomy plates.



332.350
Inserter/Extractor
length 175mm, for infant hip plate and mini hip plate.



329.290
ending Pliers for Reconstruction Plates 2.7 and 3.5
length 240mm



329.150¹
Bending Pliers for plate 2.4 to 4.0
length 230mm



329.240
Bending Pliers for plates



329.250 Alivis, narrow
329.260 Alivis, large



329.300
Bending Press
length 400mm



391.950¹
Cutter for thin plates 1.5 to 2.7
length 256mm



329.270¹
Bending Pliers
for reconstruction plates 2.7,
length 270mm, required in pairs



391.230¹
Cerclage Wire Tightener
length 260mm
for twisting, for temporary fixation during reduction



321.120¹
Tension Device, articulated
Span 20mm, can also be used as a distractor.
Colour scale: yellow up to 500N, green up to 1000N,
red above 1000N.



332.090¹
Chisel Guide
with adjustable angle



399.010
Forceps with Sliding Blades
complete with two interchangeable blades
length 155mm, weight 42 g, speed lock



399.020
Blade with foot
single



399.030
Blade with tip
single



319.020
Measuring Device
for drill bits, screws, Kirschner wires, and Steinmann pins



319.440¹
Holding Clip



391.100²
Wire Passer
45mm bending diameter



391.130¹
Wire Passer
70mm bending diameter



391.210¹
Wire Tightener
length 240mm, with handle and two pegs

Instruments For Trumatology



312.300¹
Insert Drill Sleeve 3.5/2.5
length 42mm, drill bit 2.5mm dia.



312.480¹
Insert Drill Sleeve 4.5/3.2
length 80mm
for long lag screws



319.310¹
Trocar 2.0mm dia.
Length 118mm, for percutaneous insertion of 7.0mm cannulated screws



319.320¹
Drill Sleeve 4.5/2.0
length 109mm, for percutaneous insertion of 7.0mm cannulated screws



319.330¹
Drill Sleeve 8.0/4.5
length 100mm, for percutaneous insertion of 7.0mm cannulated screws



322.260¹
Handle for Drill Guides
single



397.300¹
Drill Sleeve 3.0 with point
length 55mm



322.260¹
Handle for Drill Guides
for nos. 397.150 to 170.single



Item	For diameter
397.150	1.5mm
397.160	2.0/2.7mm



397.170¹
Drill Sleeve 2.7



312.140¹
Double Drill Sleeve 1.5/1.01
for 1.5mm cortex screws
drill bits, 1.5 and 1.1mm dia



312.220¹
Double Drill Sleeve 2.0/1.5
for 2.0mm cortex screws



312.240¹
Double Drill Sleeve 2.7/2.0
for 2.7mm cortex screws



312.280¹
Double Drill Sleeve 3.5/2.5
for 3.5mm cortex screws and 4.0mm cancellous
bone screws
drill bits 3.5 and 2.5 dia.,



312.460¹
Double Drill Sleeve 4.5/3.2
for 4.5mm cortex screws
drill bits: 4.5 and 3.2mm dia



312.670¹
Double Drill Sleeve 6.5/3.2
for 6.5mm cancellous bone screws
drill bit: 3.2mm dia.



323.260¹
Universal Drill Sleeve 2.7
Drill bits 2.0 and 2.7mm dia.,
Suitable for LC-DCP and round hole plates.



323.360¹
Universal Drill Guide 3.5
Drill bit 2.5 and 3.5mm dia., And tissue protection
for taps nos.
311.310/320/340, Suitable for LC-DCP and
round hole plates.



323.460¹
Universal Drill Guide 4.5/3.2
Drill bits 3.2 and 4.5mm dia.



322.150¹
DCP Drill Guide 2.0
for neutral and load position
drill bit 1.5mm dia.



322.210¹
DCP Drill Guide 2.7
for neutral and load position
drill bit 2.0mm dia.



322.320¹
DCP Drill Guide 3.5
for neutral an load position, drill bit 2.5mm dia.

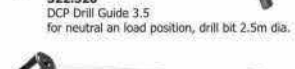

322.440¹
DCP Drill Guide 4.5
for neutral and load position, drill bit 3.2mm dia.



323.350¹
LC-DCP Drill Guide 3.5
for neutral an load position, drill bit 2.5mm dia.

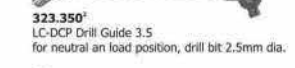

323.450¹
LC-DCP Drill Guide 4.5
for neutral and load position, drill bit 3.2mm dia.

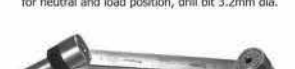

322.430¹
DCP Hip Drill Guide 4.5
for neutral and load position, for 4.5mm screws with DHS and
angled blade plates, sleeve length 60mm, drill bit 3.2mm dia.



312.200¹
Triple Drill Sleeve 2.0
with 3 holes, opposite side 1 hole



322.240¹
DCP Mandible Drill Guide 2.7 short
drill bit 2.0mm dia



322.250¹
DCP Mandible Drill Guide 2.7 long
drill bit 2.0mm dia



312.330¹
Insert Drill Sleeve wit stop, for 4.5mm screws
adjustable length to limit drilling depth,
external dia. 4.5mm for drill bits of 3.2mm dia.



319.340¹
Protection Sleeve 11.0/8.0
for percutaneous insertion of 7.0mm cannulated screws



319.300¹
Parallel drill Guide 4.5
for percutaneous insertion of 7.0mm cannulated screws



314.090¹
Holding Sleeve
length 80mm, for 2.7 to 4.0mm screws



314.080¹
Holding Sleeve for
lengt 80mm for 2.7mm screws and
3.5mm cannulated screws



314.280¹
Holding Sleeve, large, length 120mm
for Nos. 314.190/240/260/270/275



319.010¹
Depth Gauge for 2.7 to 4.0m screws
measuring range up to 60mm



319.010¹
Depth Gauge for 2.7 to 4.0m screws
measuring range up to 60mm



319.100¹
Depth Gauge for 4.5mm to 6.5mm screws
measuring range up to 110mm

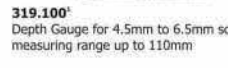

319.970¹
Screw Forceps, self-holding
length 85mm, to take screws out of the screw racks



312.470¹
Drill Sleeve, pointed



Bending Iron for plates 2.7 and 3.5
Length 150mm, slid widths 2.5 and 4.5mm, required pairs

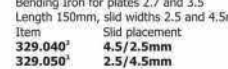

Item	Slid placement
329.040 ¹	4.5/2.5mm
329.050 ¹	2.5/4.5mm



Item	Length	Slid width
329.010 ¹	130mm	2.5mm



329.020¹
Bending Iron LC-DCP/DCP
length 250mm, for small and broad LC-DCP, DCP
slit widths 5 and 7mm, Required in pairs

Instruments For Trumatology

Drill Bits for Quick Coupling

Drill bit 1.1mm dia
for threaded hole for 1.5mm screws

Drill bit 1.5mm dia.
For threaded hole for 2.0mm screws and gliding hole for 1.5mm screws

Drill bit 2.0mm dia.
For threaded hole for 2.7 mm dia.
For gliding hole for 2.7mm screws

Item	Diameter	Total length	Usable length
310.110 ^o	1.1mm	060mm	035mm
310.150 ^o	1.5mm	085mm	060mm
310.160 ^o	1.5mm	110mm	085mm
310.190 ^o	2.0mm	100mm	145mm
310.120	2.0mm	125mm	100mm
310.210 ^o	2.7mm	100mm	075mm
310.280	2.7mm	125mm	100mm
310.260 ^o	2.7mm	100mm	075mm
310.280 ^o	2.0mm	125mm	100mm

Drill bit 2.5mm dia.
For threaded hole for 3.5 and 4.0mm screws

Drill bit 3.5mm
for gliding hole for 3.5mm screws

Item	Diameter	Total length	Usable length
310.250 ^o	2.5mm	110mm	085mm
310.230	2.5mm	180mm	155mm
310.350 ^o	3.5mm	100mm	085mm
310.370	3.5mm	195mm	170mm

Drill bit 3.2mm dia.
For threaded hole for 4.5 and 6.5mm screws

Drill bit 4mm dia.
For gliding hole for 4.5mm screws

Item	Diameter	Total length	Usable length
310.190 ^o	2.0mm	100mm	145mm
310.020	3.2mm	225mm	200mm
310.310 ^o	3.2mm	145mm	120mm
310.290	3.2mm	195mm	170mm
310.440 ^o	4.5mm	145mm	120mm
310.480	4.5mm	195mm	170mm

Drill Bits for Jacobs Type Chuck

Drill Bit for Jacobs chuck

Item	Diameter	Total length	Usable length
310.100	1.1mm	45mm	30mm
310.140	1.5mm	70mm	55mm
310.200	2.0mm	85mm	70mm
310.240	2.5mm	095mm	080mm
310.270	2.7mm	85mm	70mm
310.320	3.2mm	130mm	115mm
310.300	3.2mm	180mm	165mm
310.360	3.5mm	095mm	080mm
310.380	3.5mm	180mm	165mm
310.450	4.5mm	130mm	115mm
310.490	4.5mm	180mm	165mm

Tap for 2.0mm Cortex Screws
Predrilling: 1.5mm dia.

Item	Thread length	Total length
311.190 ^o	24mm	053mm
311.210	38mm	100mm

Tap for 2.7mm Cortex Screws
Predrilling: 2.0mm dia.

Item	Thread length	Total length
311.260 ^o	33mm	100mm
311.280	40mm	150mm

Tap for 3.5mm Cortex Screws
Predrilling: 2.5mm dia.

Item	Length	Type
311.460 ^o	125mm	thread length 70mm
311.470	175mm	with length markings

Tap for 4.5mm and 6.5mm Cortex Screws
Predrilling: 4mm dia.

Item	Length	Type
311.310	175mm	with length markings
311.320 ^o	110mm	thread length 50mm

311.280^o
Tap for 2.7mm Cortex Screws
total length 125mm, thread length 40mm
predrilling: 2.0mm dia.

311.150^o
Tap for 1.5mm Cortex Screws
total length 50mm, thread length 20mm
predrilling: 1.1mm dia.

311.660^o
Tap for 6.5mm Cancellous Bone Screws
length 195mm, predrilling: 3.2mm dia.

Tap for 4.0mm Cancellous Bone Screws

Item	Total length	Usable length
311.340 ^o	110mm	085mm

311.690^o
Tap, Cannulated, for 7.0mm Cannulated Screws
length 230mm

311.320
Tap for 3.5mm Cortex Screws
total length 110mm, thread length 50mm
predrilling: 2.5mm dia.

311.460^o
Tap for 4.5mm Cortex Screws
total length 125mm, thread length 70mm
predrilling: 3.2mm dia.

310.880^o
Countersink Shaft 1.5/2.0
length 52mm, for mini quick coupling

332.050
Router, for Jacobs chuck
length 90mm

332.060^o
Router, for quick coupling
length 90mm

310.990^o
Countersink, large
length 180mm, for 4.5mm cortex screws

310.890^o
Countersink Shaft 3.5mm
length 72mm, for quick coupling,
to countersink the screw head

310.790
Dountersink, cannulated, for 7.0mm Cannulated Screws
length 230mm

310.950^o
Handle with mini quick coupling

392.040
Hand Chuck for Kirschner Wires
length 145mm, Spannbereich 0.6 to 1.6mm dia.

311.430^o
Handle with quick coupling
length 110mm
for countersinks and
instruments for the removal of damaged screws

311.440^o
T-Handle with quick coupling
length 80mm, for taps

311.011
Handle, small, with mini quick coupling

311.012
Handle, medium, with mini quick coupling

311.013
Handle, large, with mini quick coupling

314.140
Allen Key, hexagonal, angled
for 4.5 to 7.0mm screws

314.160
Allen Key, hexagonal, small, angled
length 65mm, for 2.7 to 4.0mm screws

314.030^o
Screwdriver Shaft, hexagonal, small
length 100mm, for quick coupling
For 2.7 to 4.0mm screws.

314.320^o
Screwdriver Shaft, hexagonal, with Holding Sleeve
fro 1.5 and 2.0mm stainless steel screws
with hexagonal socket,

314.130
Screwdriver, hexagonal, with T-Handle,
large to loosen tight screws.
A normal screwdriver can be
additionally inserted in the hollow
shaft of the T-handle.

314.170
Screwdriver with Universal Joint, large
length 290mm

314.300
Screwdriver, hexagonal, with Holding Sleeve,
length 165mm for 1.5 and 2.0mm stainless
steel screws with hexagonal socket.

314.060
Holding Sleeve

314.150^o
Screwdriver Shaft, Hexagonal, large
length 100mm,
Final tightening of the screw has to
be done by hand.

314.670^o
Screwdriver Shaft, cruciform, 1.5/2.0, with Holding Sleeve
length 50mm, for 1.5 and 2.0mm

314.070^o
Screwdriver, hexagonal, small with groove
length 200mm, for 2.7 to 4.0mm screws

314.270^o
Screwdriver, hexagonal, large, with groove
length 240mm

314.020^o
Screwdriver, hexagonal, small, with Holding Sleeve
length 200mm

314.060^o
Holding Sleeve for no. 314.030
single, as spare

313.980
Holding Sleeve for Mini Screws
single

Carbide Insterted Wired-Pin Cutting Pliers

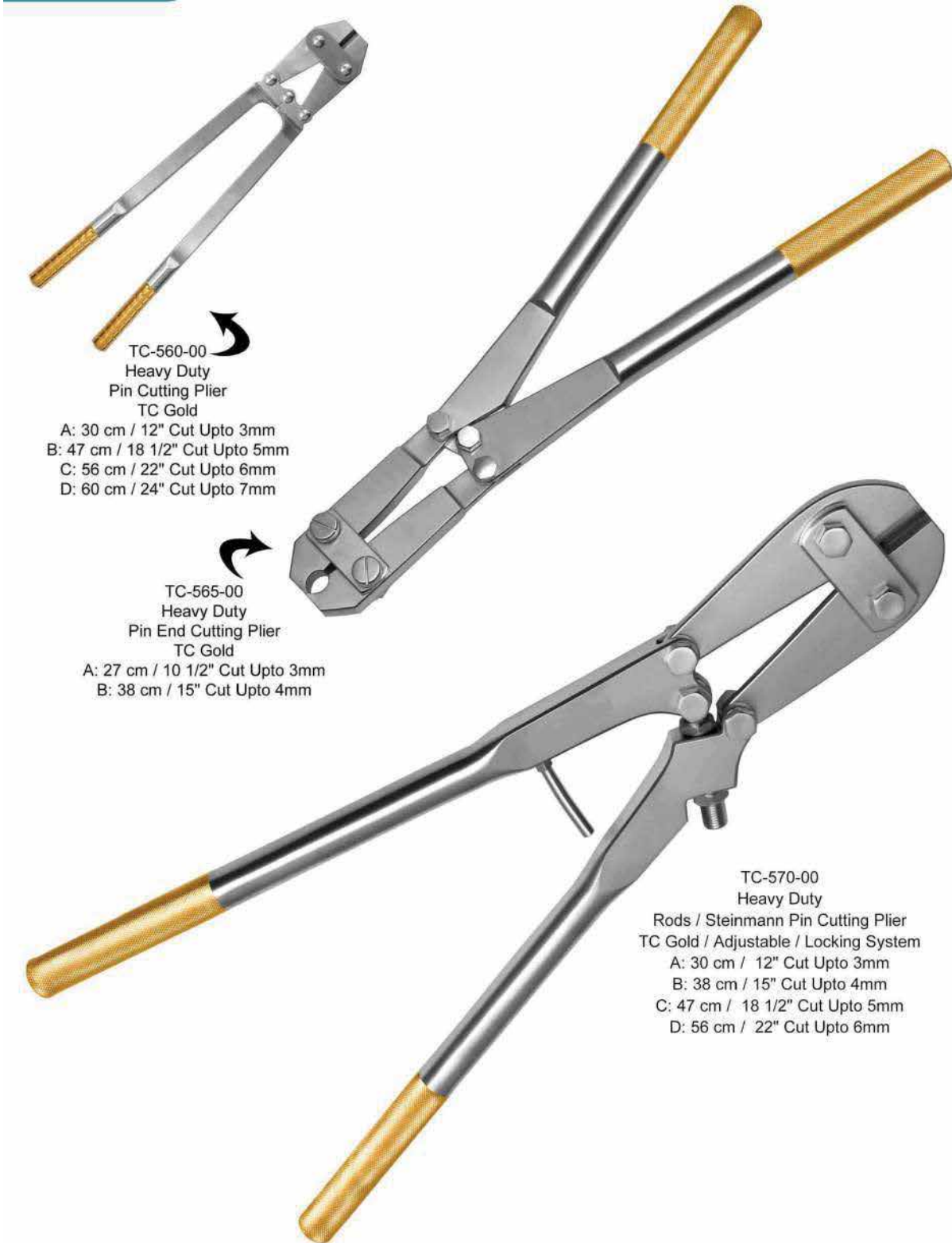

TC-560-00
Heavy Duty
Pin Cutting Plier
TC Gold
A: 30 cm / 12" Cut Upto 3mm
B: 47 cm / 18 1/2" Cut Upto 5mm
C: 56 cm / 22" Cut Upto 6mm
D: 60 cm / 24" Cut Upto 7mm

TC-565-00
Heavy Duty
Pin End Cutting Plier
TC Gold
A: 27 cm / 10 1/2" Cut Upto 3mm
B: 38 cm / 15" Cut Upto 4mm

TC-570-00
Heavy Duty
Rods / Steinmann Pin Cutting Plier
TC Gold / Adjustable / Locking System
A: 30 cm / 12" Cut Upto 3mm
B: 38 cm / 15" Cut Upto 4mm
C: 47 cm / 18 1/2" Cut Upto 5mm
D: 56 cm / 22" Cut Upto 6mm

Carbide Insterted Wired-Pin Cutting Pliers

TC-540-23
Plate / Pin Cutting Plier
TC Gold
23 cm / 9"
Cut Upto 3.0mm



TC-545-23
Pin / Wire Cutting Plier
TC Gold / Adjustable
23 cm / 9"
Cut Upto 2.5mm

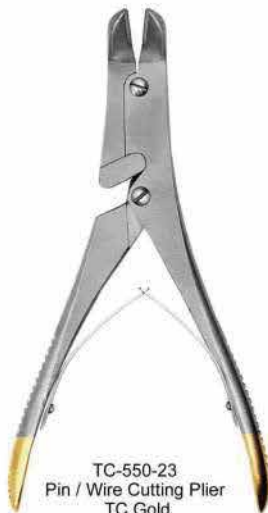
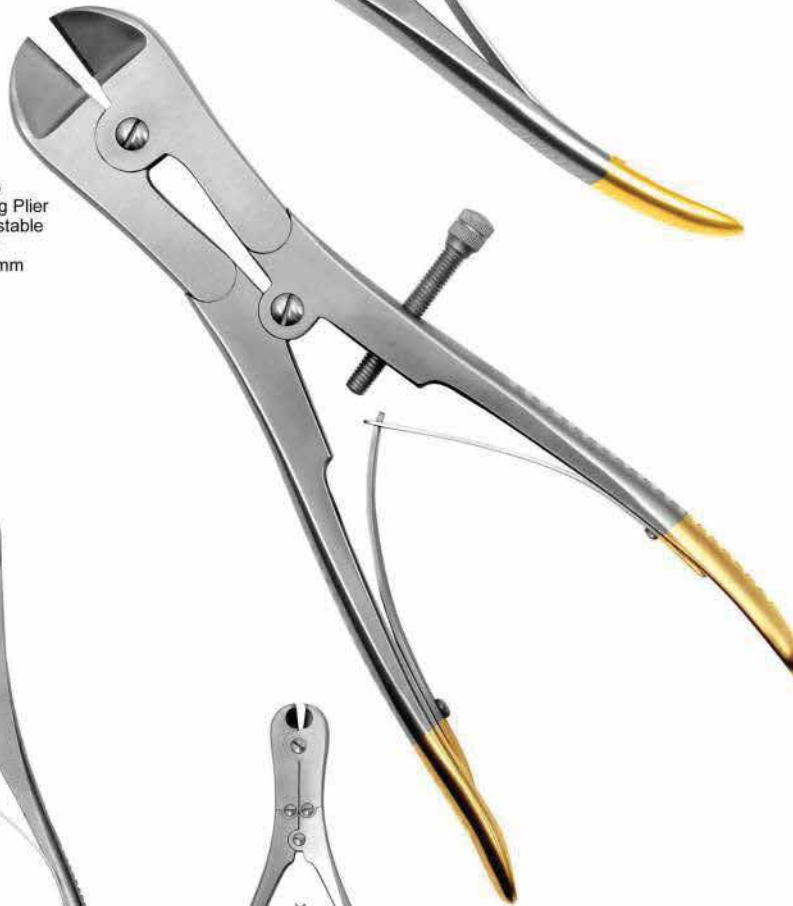

TC-550-23
Pin / Wire Cutting Plier
TC Gold
23 cm / 9"
Cut Upto 2.5mm



TC-555-18
Front / Side
Wire Cutting Plier
TC Gold
18 cm / 7"
Cut Upto 1.6mm

Carbide Insterted Wired-Pin Cutting Pliers

TC-520-18
Cannulated Pin Cutter TC Gold
18 cm / 7" Cut Upto 1.5mm



TC-525-15
Front End
Wire Cutting Plier
TC Gold
15 cm / 6"
Cut Upto 1.3mm

TC-530-26
Front End
Wire Cutting Plier
TC Gold
23 cm / 9"
Cut Upto 2.5mm



TC-535-23
Front End
Wire Cutting Plier
TC Gold
23 cm / 9"
Cut Upto 2.5mm

Carbide Insterted Wired-Pin Cutting Pliers

TC-500-00
Wire Cutting Plier TC Gold
A: 15 cm / 6" Cut Upto 1.3mm
B: 18 cm / 7" Cut Upto 1.6mm
C: 23 cm / 9" Cut Upto 2.5mm

Angled

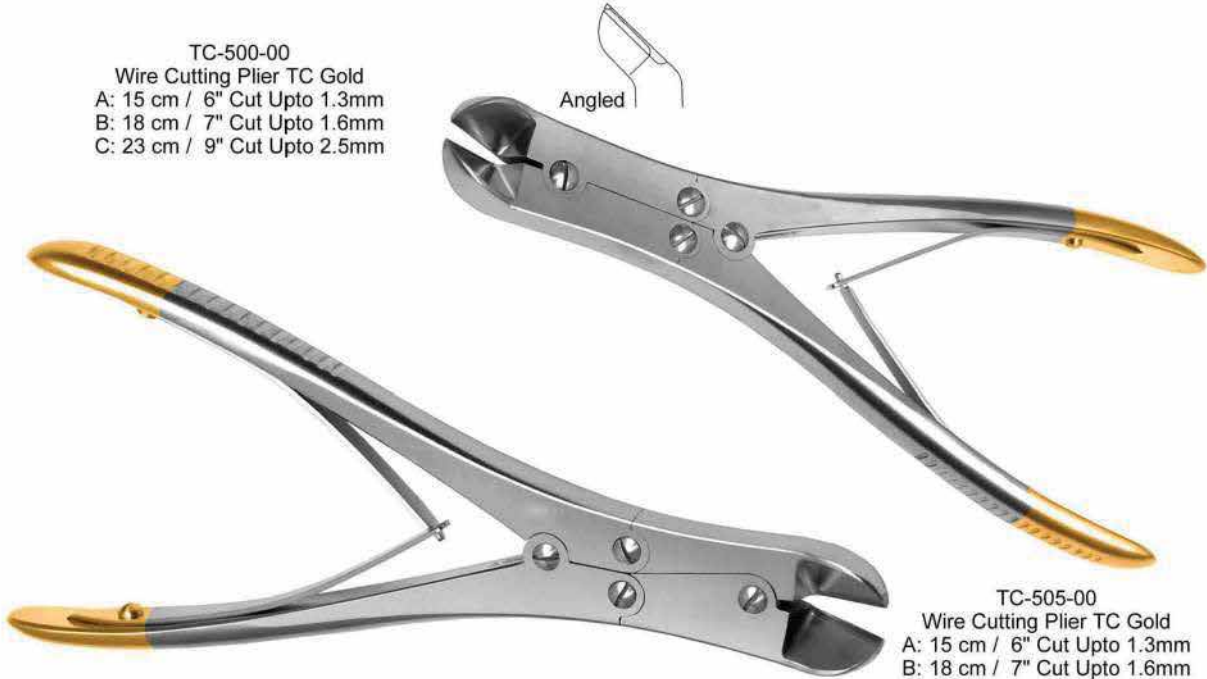

TC-505-00
Wire Cutting Plier TC Gold
A: 15 cm / 6" Cut Upto 1.3mm
B: 18 cm / 7" Cut Upto 1.6mm

TC-510-23
Wire Cutting Plier TC Gold
23 cm / 9" Cut Upto 2.5mm



TC-515-18
Wire Cutting Plier TC Gold
18 cm / 7" Cut Upto 1.6mm

Carbide Insterted Surgical Scissors

Scissors in this Section can also be Manufactured without Carbide Tips / Gold Plating

TC-30-00
Mayo
Scissors TC Gold
A: 14.5 cm / 5 3/4" Str or Cvd
B: 17 cm / 6 3/4" Str or Cvd
C: 23 cm / 9" Str or Cvd

Blunt / Blunt

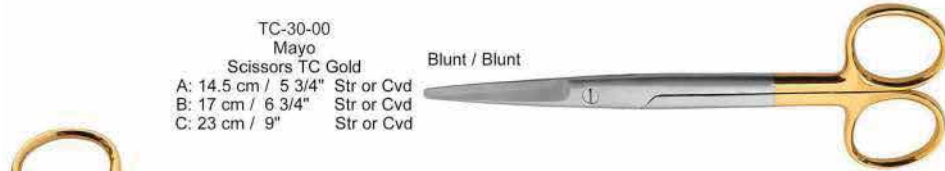

TC-31-00
Operating (Standard)
Scissors TC Gold
A: 13 cm / 5" Str or Cvd
B: 14 cm / 5 1/2" Str or Cvd
C: 15.5 cm / 6 1/2" Str or Cvd
D: 18 cm / 7" Str or Cvd

Sharp / Sharp Cvd or Str Blunt / Blunt Cvd or Str Sharp / Blunt Cvd or Str

Please Mention Above Styles When Ordering Standard TC Scissors

TC-32-00
Mayo Stille
Scissors TC Gold
A: 14.5 cm / 5 3/4" Str or Cvd
B: 17 cm / 6 3/4" Str or Cvd
C: 23 cm / 9" Str or Cvd

Blunt / Blunt

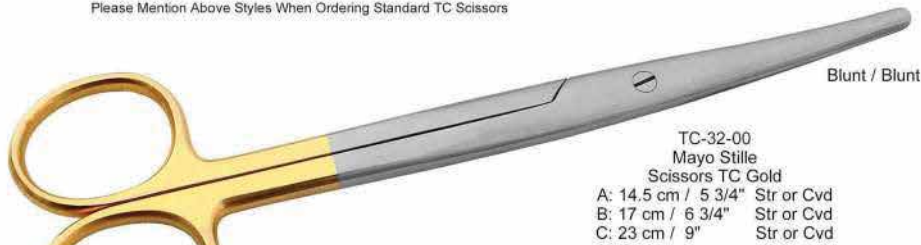

www.LeBord.com

TC-33-00
Metzenbaum
Scissors TC Gold
A: 14 cm / 5 1/2" Str or Cvd
B: 17 cm / 6 3/4" Str or Cvd
C: 20 cm / 8" Str or Cvd
D: 23 cm / 9" Str or Cvd

Blunt / Blunt



TC-34-00
Mayo-Harrington
Scissors TC Gold
A: 20 cm / 8" Str or Cvd
B: 23 cm / 9" Str or Cvd
C: 28 cm / 11" Str or Cvd
D: 30 cm / 12" Str or Cvd

Blunt / Blunt



TC-35-12
Ortho Universal Scissors TC Gold
12 cm / 4 1/3"



TC-36-16
Mayo-Nobel
Scissors TC Gold
A: 16.5 cm / 6 1/2" Str or Cvd



Carbide Insterted Wire Twisters

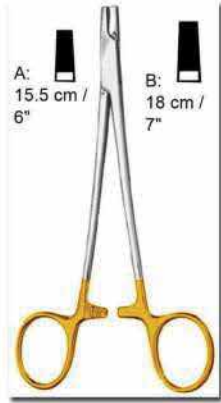

TC-20-00 A / B
Wire Twisting
Forceps

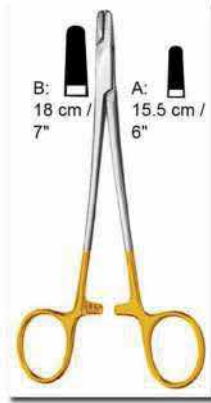

TC-21-00 A / B
Wire Twisting
Forceps

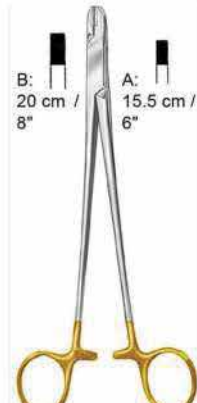

TC-22-00 A / B
Wire Twisting
Forceps



TC-23-18 Corwin
Combi-Wire Twisting
Forceps
18.5 cm / 7 1/4"



TC-24-15
Wire Twisting Forceps
15.5 cm / 6"

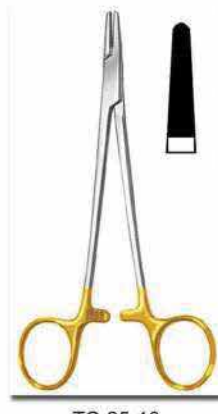

TC-25-16
Wire Twisting Forceps
16 cm / 6 1/4"



TC-26-19 Wire Twisting
Forceps Heavy Pattern
19 cm / 7 1/2"

The Corwin-Hegar automatic Wire Twister is a special automatic twisting Instrument. In combination with a cerclage wire it can be used for fixation of fractures or temporal fixation. The Automatic Wire Twisters are available in different lengths and with various tungsten carbide inserts.

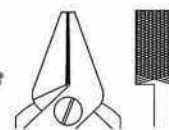

Non TC

Rod Benders

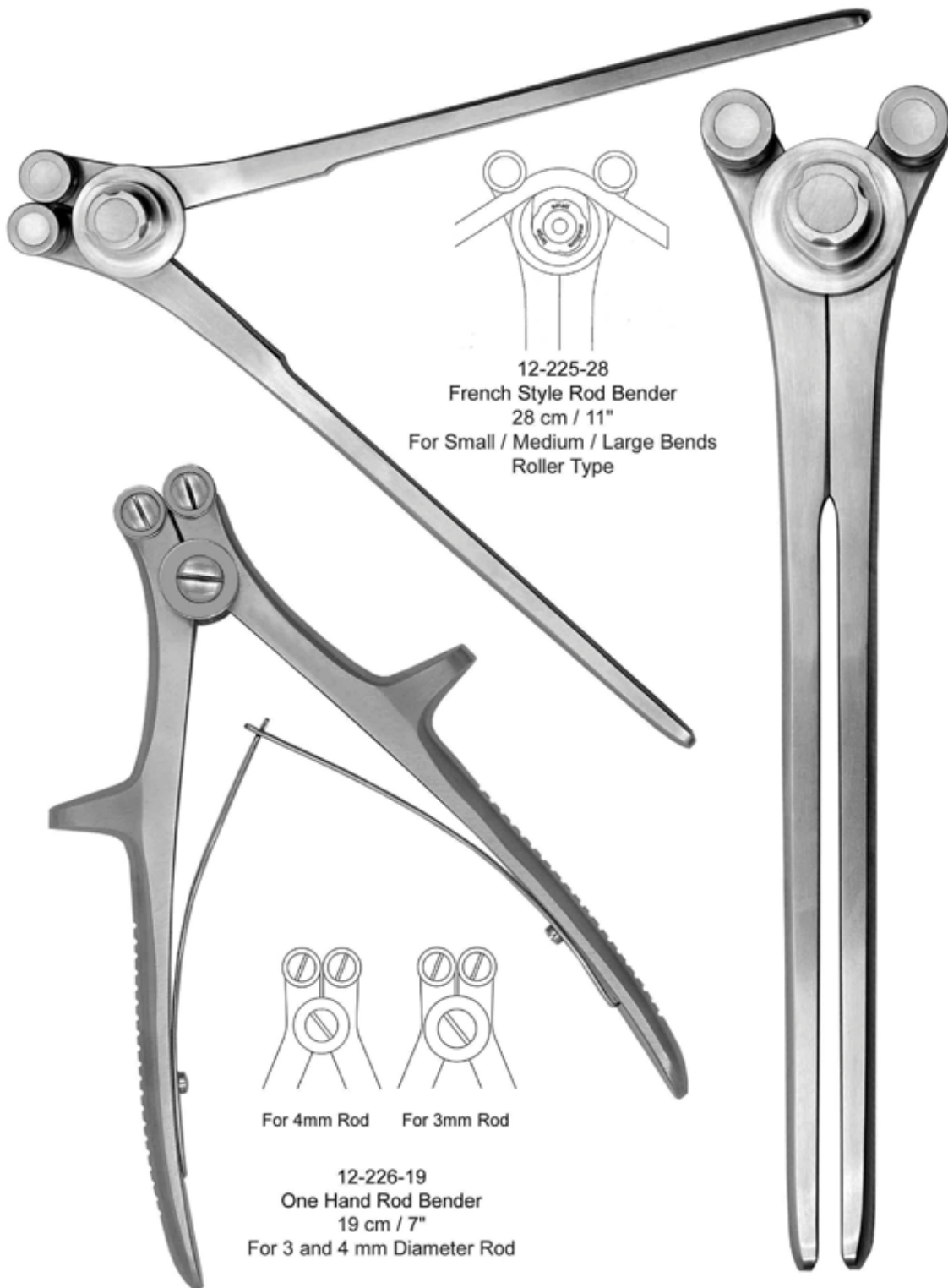

Copressors-Distractors



12-220-28
Compressing Forceps
28 cm / 11"
Adjustable Locking
For Screws and Rods



12-221-23
Distracting Forceps
23 cm / 9"
Long Ratchet / Spiral Spring
For Screws and Rods



12-222-25
Distracting Forceps
25.5 cm / 10"
Leaf Spring
For Screws and Rods



12-223-28
Compression Forceps
28 cm / 11"
Leaf Spring / Long Ratchet
For Screws and Rods

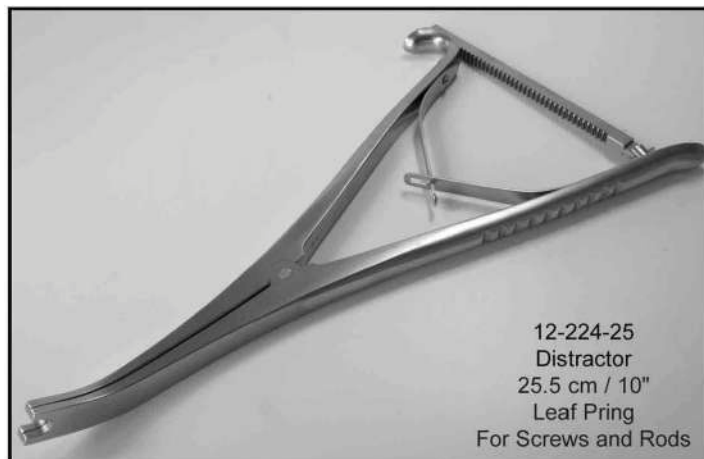

12-224-25
Distractor
25.5 cm / 10"
Leaf Spring
For Screws and Rods

Calcaneal-Lombardi Spreaders

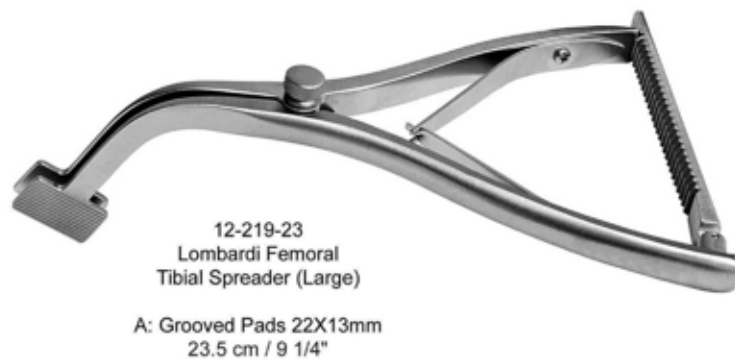

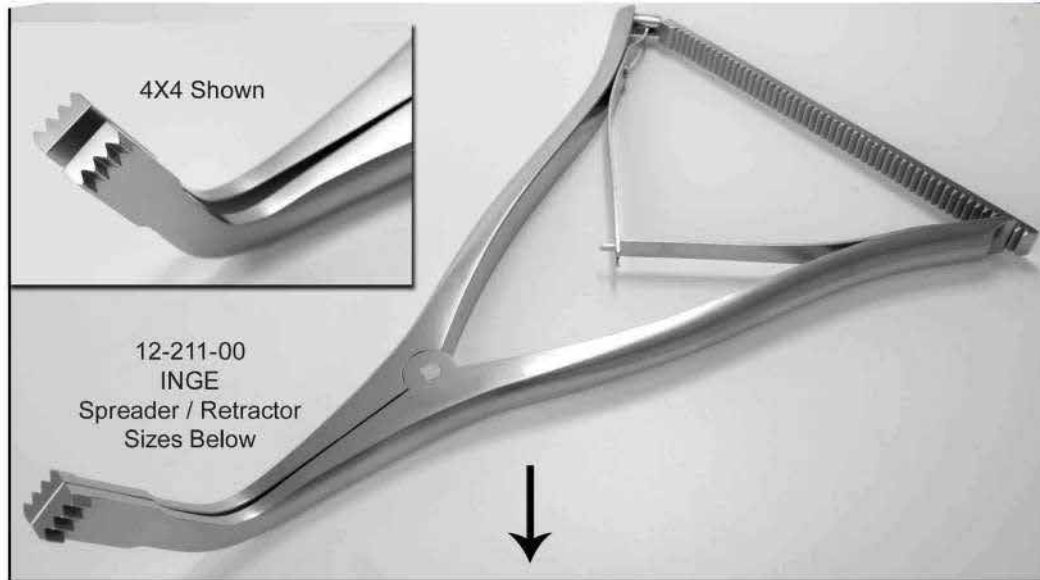

Lamina Spreaders- Retractors

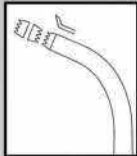
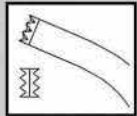
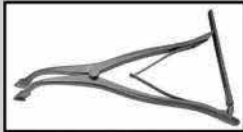
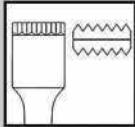
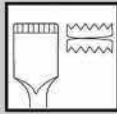

Available in 4X4 and 6X6 Teeth and Without Teeth (Plain)

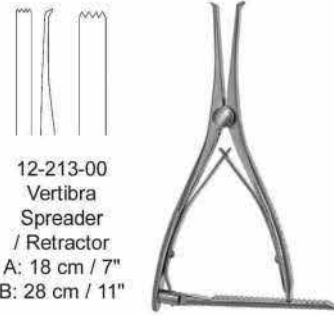
				
A: 4X4 Teeth B: Without Teeth 16.5 cm / 6 1/2"	C: 4X4 Teeth D: Without Teeth 25.5 cm / 10"	10 Inch Length Pattern	A: 6X6 Teeth B: Without Teeth 27 cm / 10 1/2" Flat Blades	C: 6X6 Teeth C: Without Teeth 27 cm / 10 1/2" Concave Blades

		
12-212-25 Offset Lamina Spreader / Retractor 25.5 cm / 10"	12-213-00 Vertebra Spreader / Retractor A: 18 cm / 7" B: 28 cm / 11"	12-214-18 Inge Spreader Serrated Outside Blades A: 18 cm / 7"

12-215-00 Saxsena Lamina Spreader / Retractor A: 18 cm / 7" B: 25.5 cm / 10" Serrated Outside Blades

Rib Shears

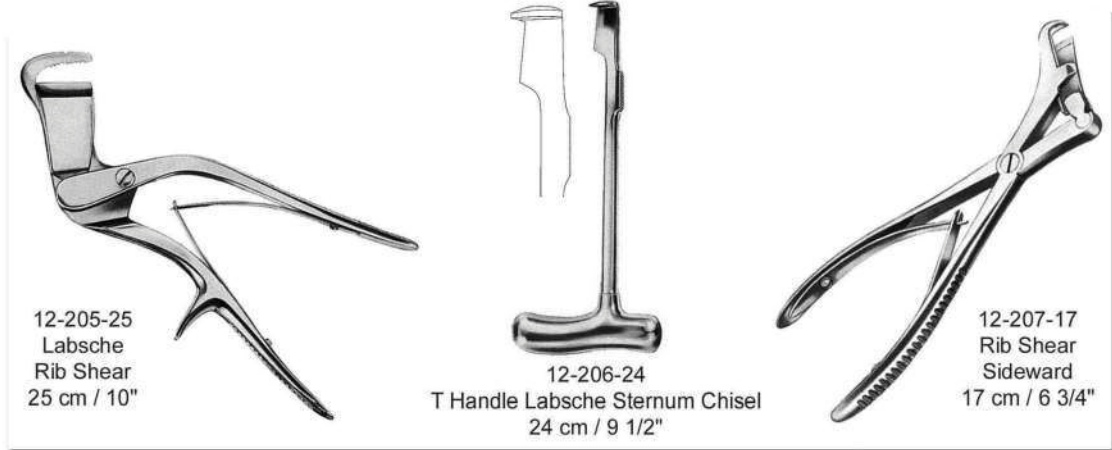

12-205-25
Labsche
Rib Shear
25 cm / 10"

12-206-24
T Handle Labsche Sternum Chisel
24 cm / 9 1/2"

12-207-17
Rib Shear
Sideward
17 cm / 6 3/4"

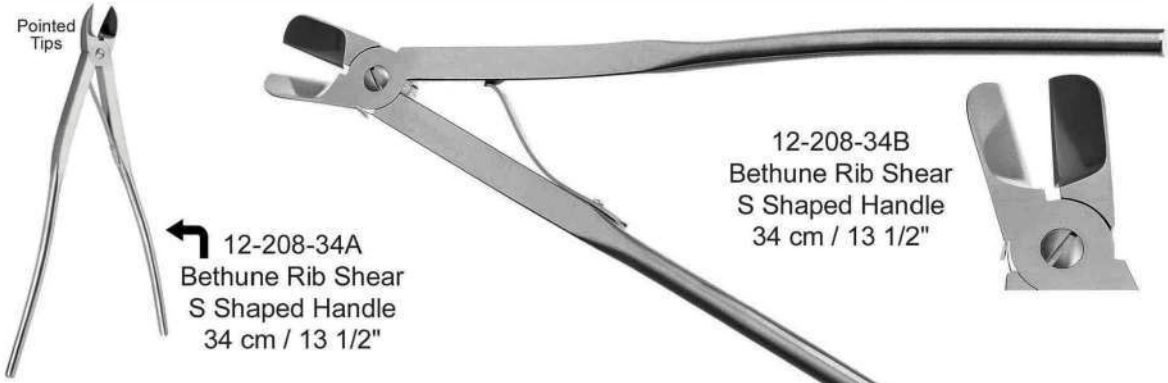

Pointed
Tips

12-208-34A
Bethune Rib Shear
S Shaped Handle
34 cm / 13 1/2"

12-208-34B
Bethune Rib Shear
S Shaped Handle
34 cm / 13 1/2"



12-209-35
Coryllos-Bethune Rib Shear
S Shaped Handle
35 cm / 13 3/2"

Left Right



12-210-33
Roos Rib Shear
Right Angled Jaw W/ Hook
33 cm / 13"

Rib Shears

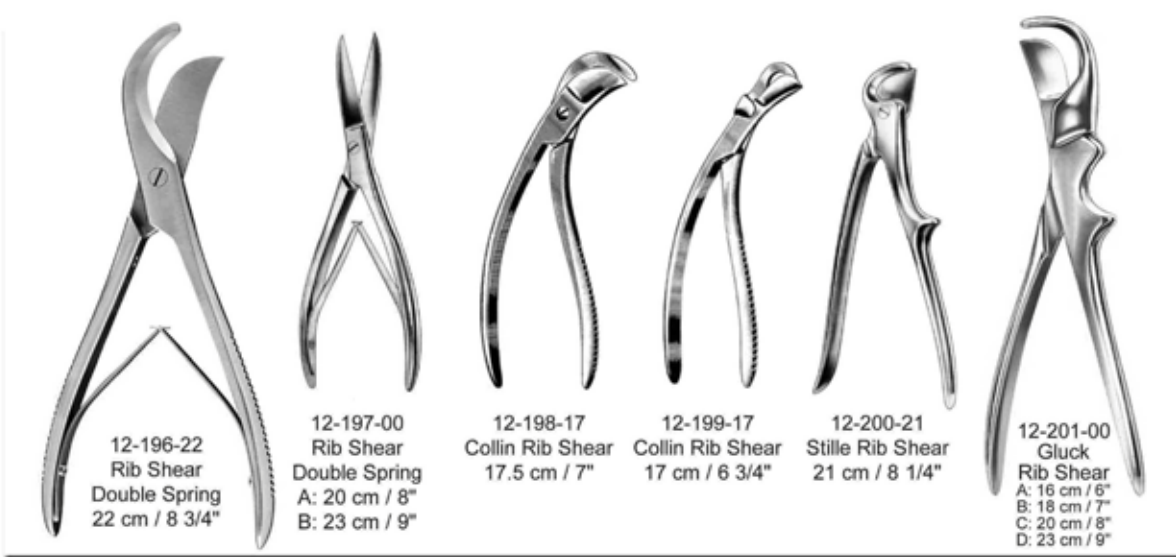

Bone Rongeur -Nibbiers

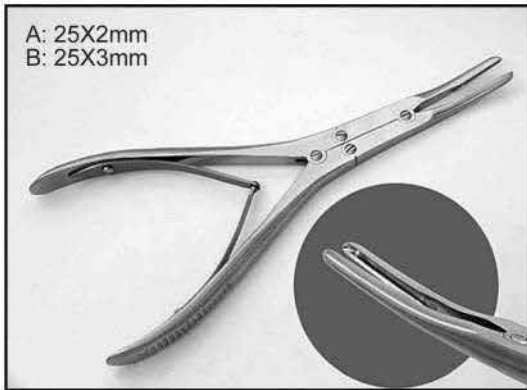

A: 25X2mm
B: 25X3mm

12-191-18
Mainz Long Neck Bone Rongeur 18 cm / 7"

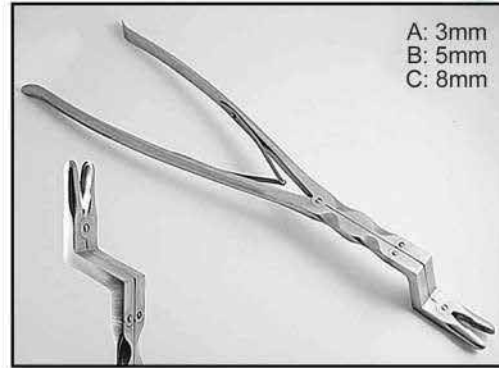

A: 3mm
B: 5mm
C: 8mm

12-192-41
Leksell Bayonet Rongeur 41 cm / 16"

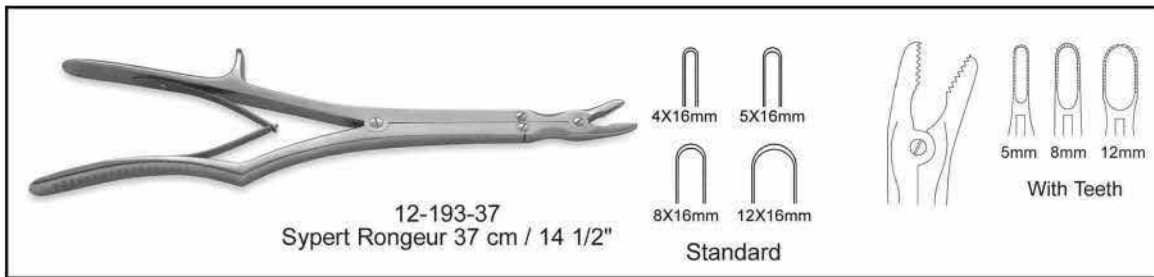

12-193-37
Syfert Rongeur 37 cm / 14 1/2"

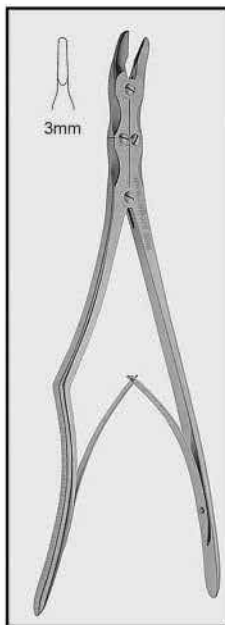
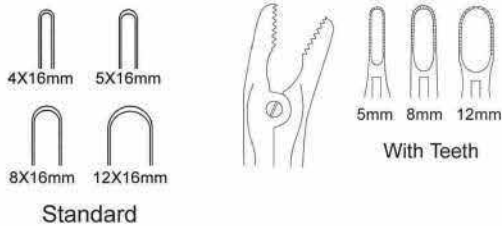

12-194-37
Dale Thoracic Rongeur 37 cm / 14 1/2"

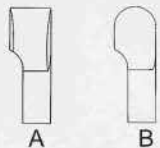
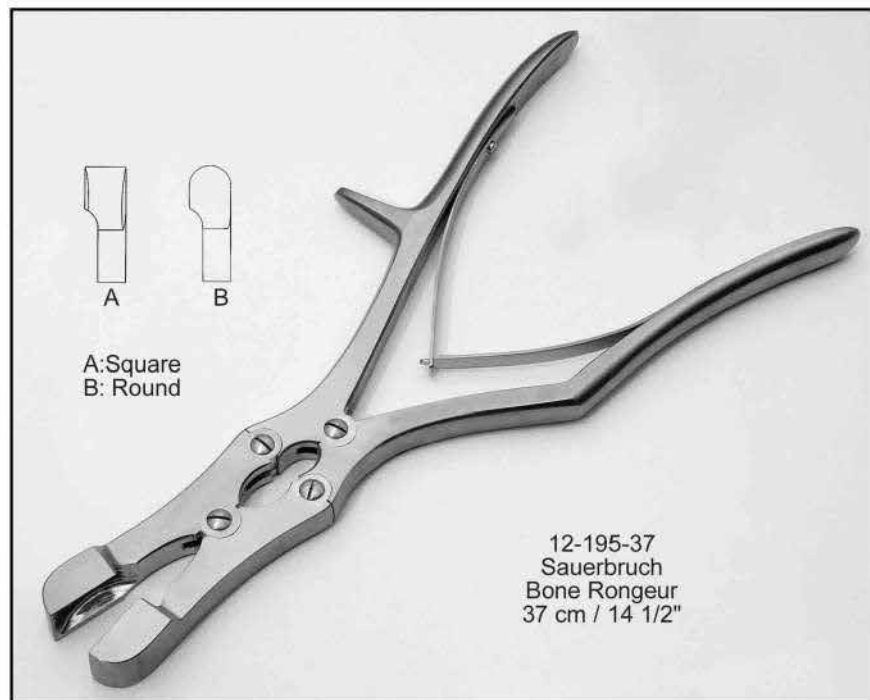

A: Square
B: Round

12-195-37
Sauerbruch Bone Rongeur 37 cm / 14 1/2"

Bone Rongeur -Nibbiars

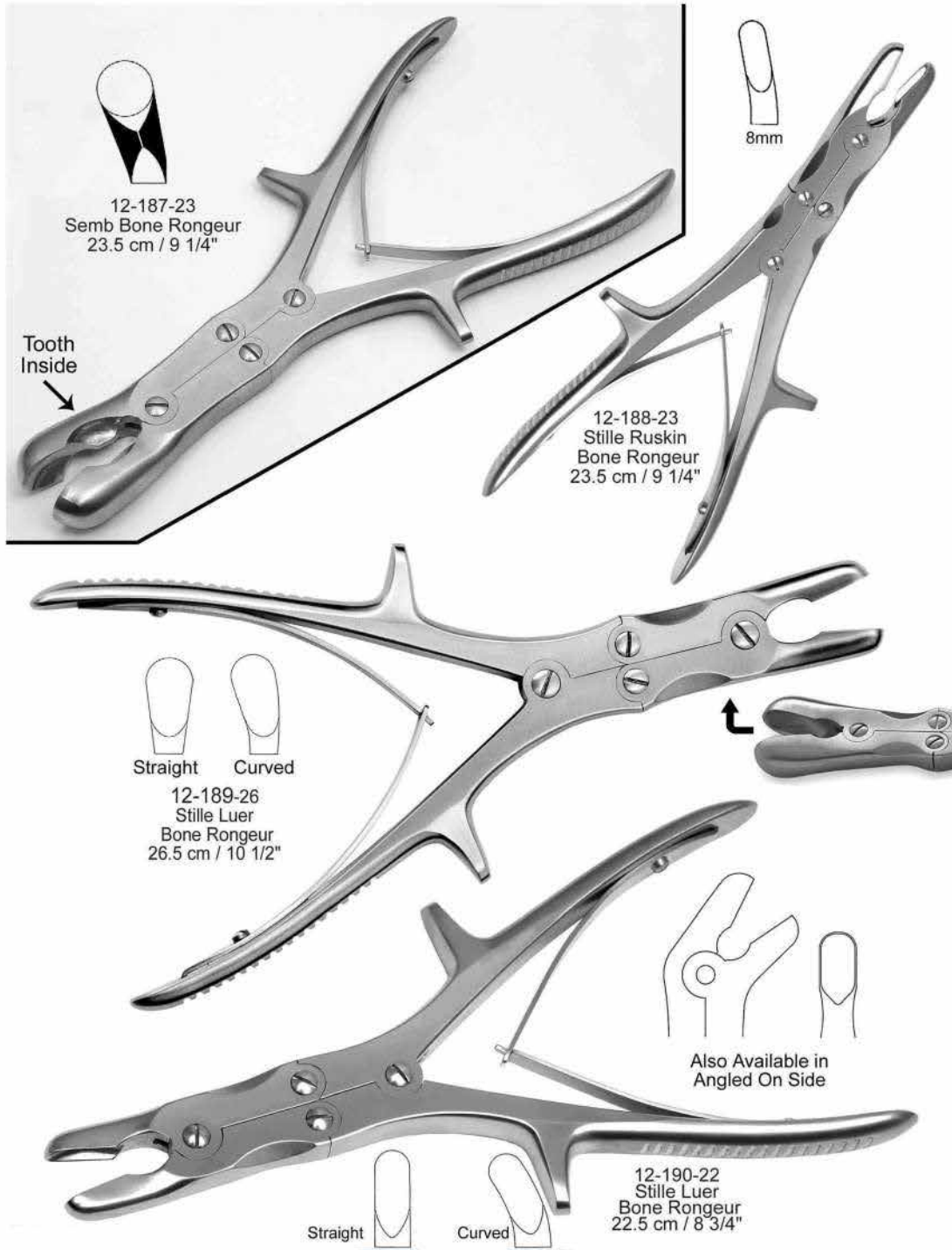

Bone Rongeur -Nibblers

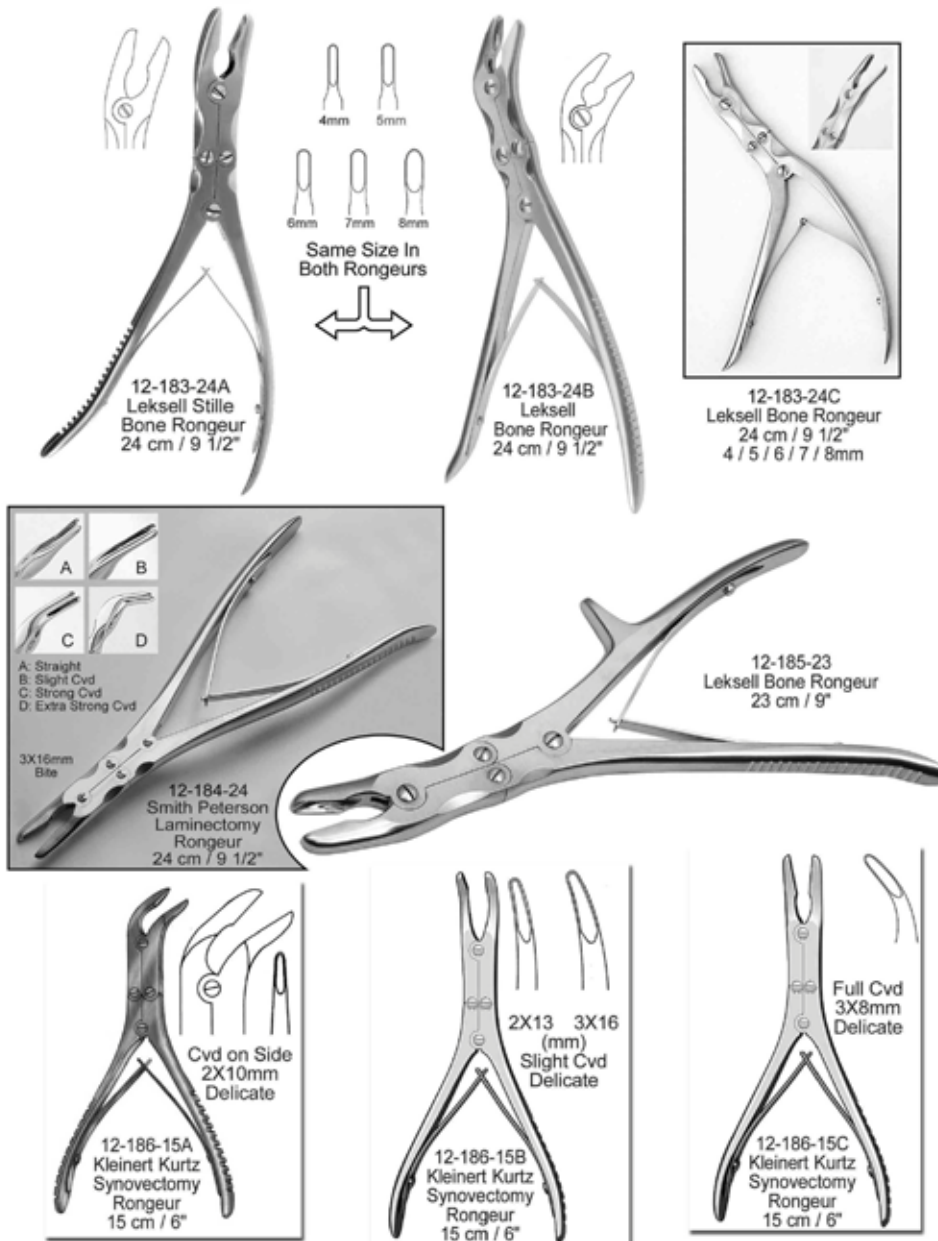

Bone Rongeur -Nibbiars



12-175-15 Böhler Bone Rongeur
15.5 cm / 6"



12-176-18 Beyer Bone Rongeur
18 cm / 7"



12-177-18 Zaufal-Jansen
Bone Rongeur 18 cm / 7"



12-178-18
Mayfield Bone Rongeur
18 cm / 7"



12-179-20 Marquard
Bone Rongeur 20.5 cm / 8"



12-180-23
Stille Bone Rongeur
22.5 cm / 8 3/4"

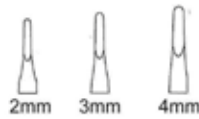
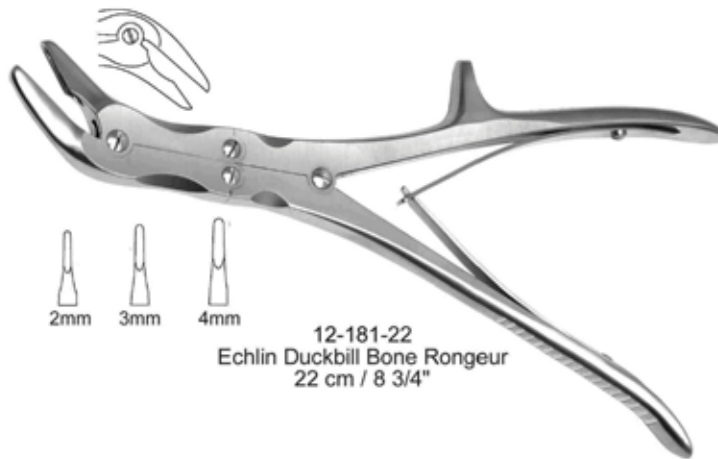

12-181-22
Echlin Duckbill Bone Rongeur
22 cm / 8 3/4"

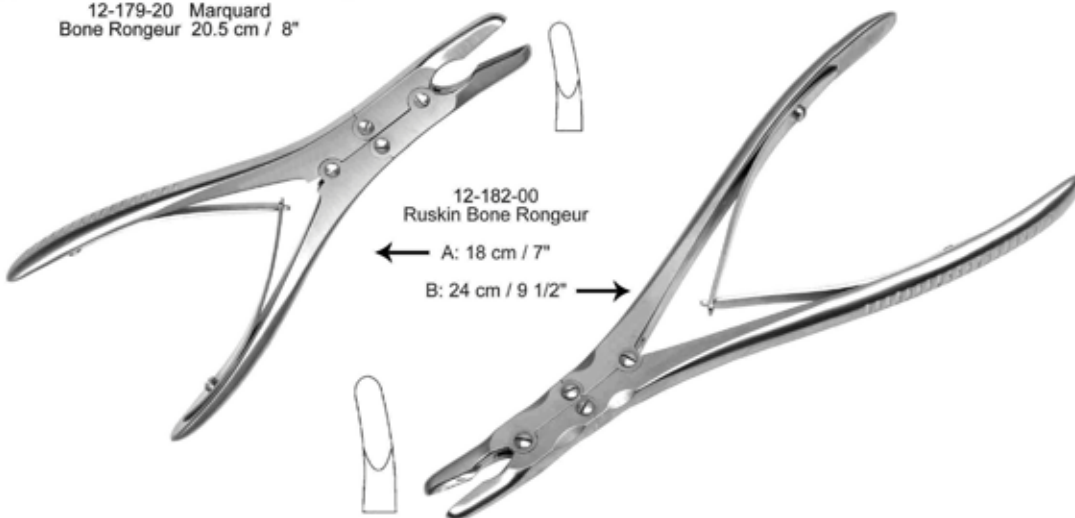

12-182-00
Ruskin Bone Rongeur

← A: 18 cm / 7"

B: 24 cm / 9 1/2" →

Bone Rongeur -Nibbiers

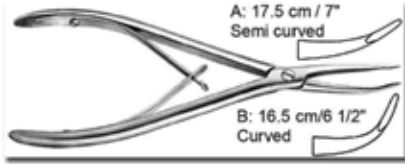

12-160-17 Stellbrink Bone Rongeur

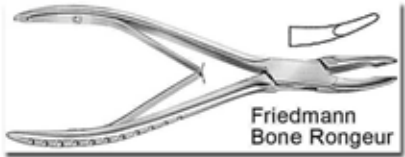

12-161-12 A: 12.5cm / 5"
B: 13.5cm / 5 1/4"



12-162-13 13.5 cm / 5 1/4"

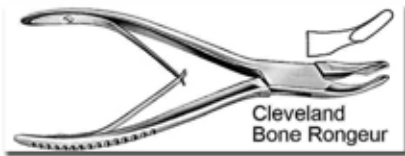

12-163-13
A: 13.5 cm / 5 1/4" B 16.5 cm / 6 1/2"



12-164-16 Mead Bone Rongeur
16.5 cm / 6 1/2"

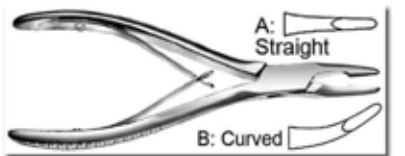

12-165-18 Jansen Bone Rongeur 18 cm / 7"

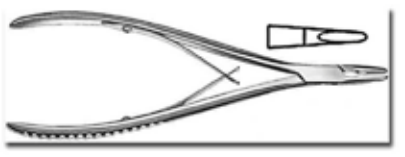

12-166-19 Lempert Bone Rongeur
19 cm / 7 1/2"



12-169-19 Jansen Bone Rongeur
19cm / 7 1/2"
Bayonet

12-170-00 Jansen Bone Rongeur
A: 14cm / 5 1/2"
B: 17cm / 6 1/2"
Straight

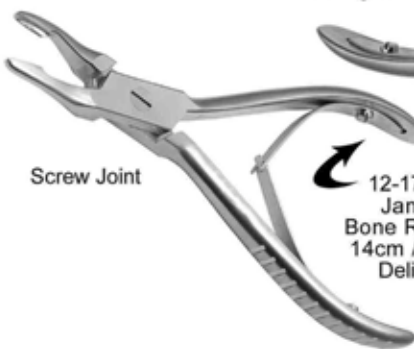
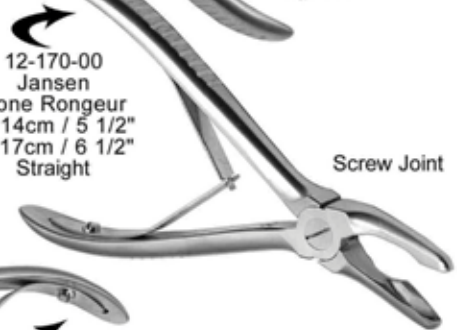

12-171-14 Jansen Bone Rongeur
14cm / 5 1/2"
Delicate



12-172-14 Luer Bone Rongeur 14.5 cm / 5 3/4"

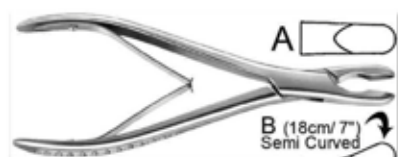

12-173-18 Luer Bone Rongeur 18.5 cm / 7 1/4"

Bone Cutting Forceps



12-157-18
Mc Indoe
Bone Cutting Forceps
18 cm / 7"
Delicate Blades



12-158-25
Stille-Horsley / Liston Key
Bone Cutting Forceps
25.5 cm / 10"

45° Angled



90° Angled

Angled On Side

12-159-24
Semb
Bone Cutting Forceps
24.5 cm / 9 3/4"

Bone Cutting Forceps

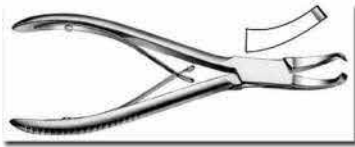

12-153-16 Cleveland
Bone Cutting Forceps 16 cm / 6 1/4"

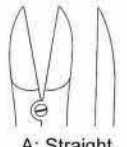

A: Straight

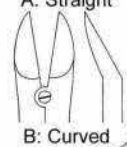

B: Curved

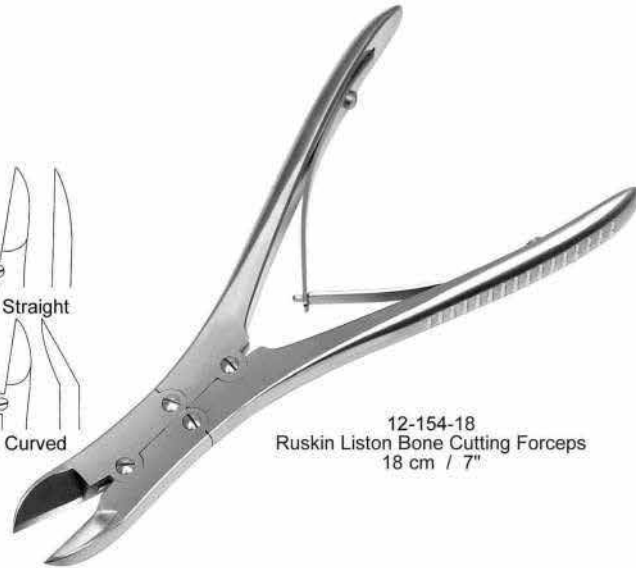

12-154-18
Ruskin Liston Bone Cutting Forceps
18 cm / 7"

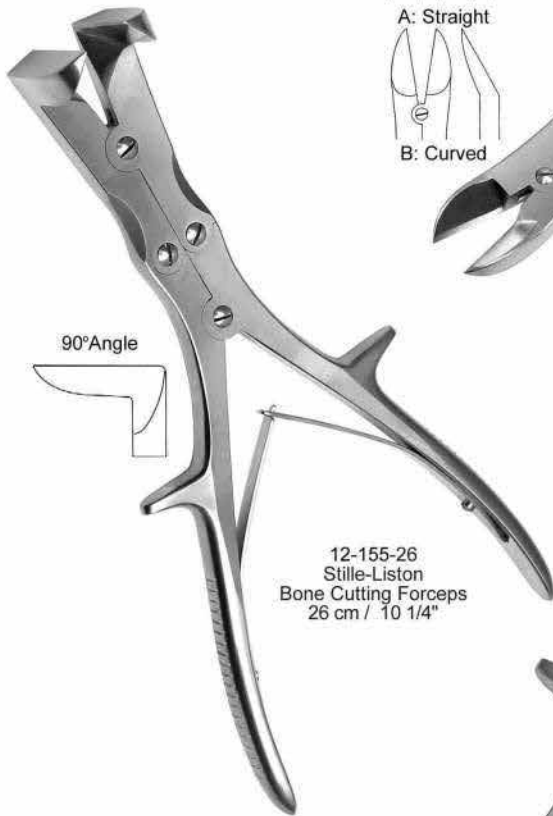

90° Angle

12-155-26
Stille-Liston
Bone Cutting Forceps
26 cm / 10 1/4"

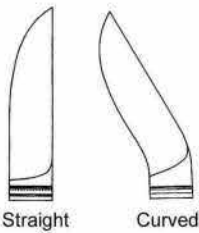

Straight

Curved

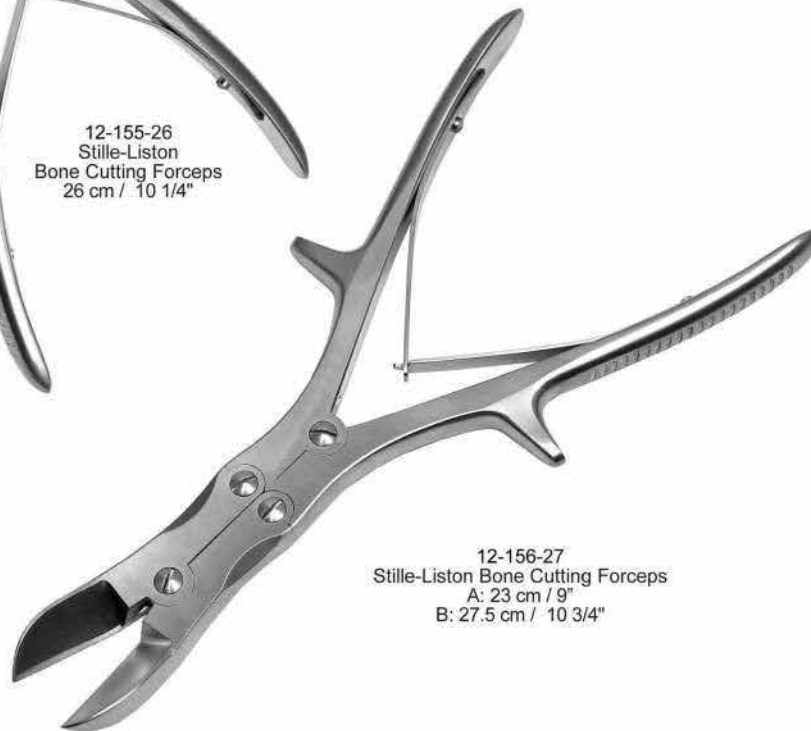

12-156-27
Stille-Liston Bone Cutting Forceps
A: 23 cm / 9"
B: 27.5 cm / 10 3/4"

Bone Cutting Forceps

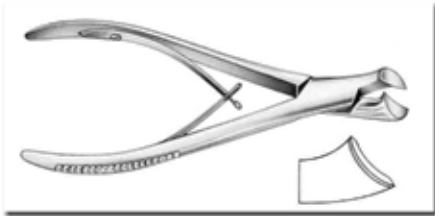

12-147-18
Marwalder Bone Nipper 18.5 cm / 7 1/4"

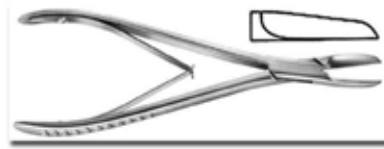

12-148-18
Cottle Kazanjian Bone Cutting Forceps
18.5 cm / 7 1/4"

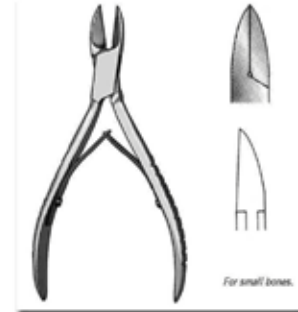

12-149-15
Littauer Bone Cutting Forceps
15 cm / 6"
For small bones.



12-150-00
Liston Bone Cutting Forceps



12-151-00
Cleveland Bone Cutting Forceps
A: 14.5 cm / 5 3/4"
B: 17 cm / 6 3/4"

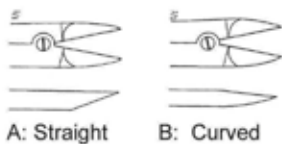

12-152-14
Kleinert-Kutz / Böhler Bone Cutting
Forceps 14.5 cm / 5 3/4"



Reposition - Cartilage Forceps

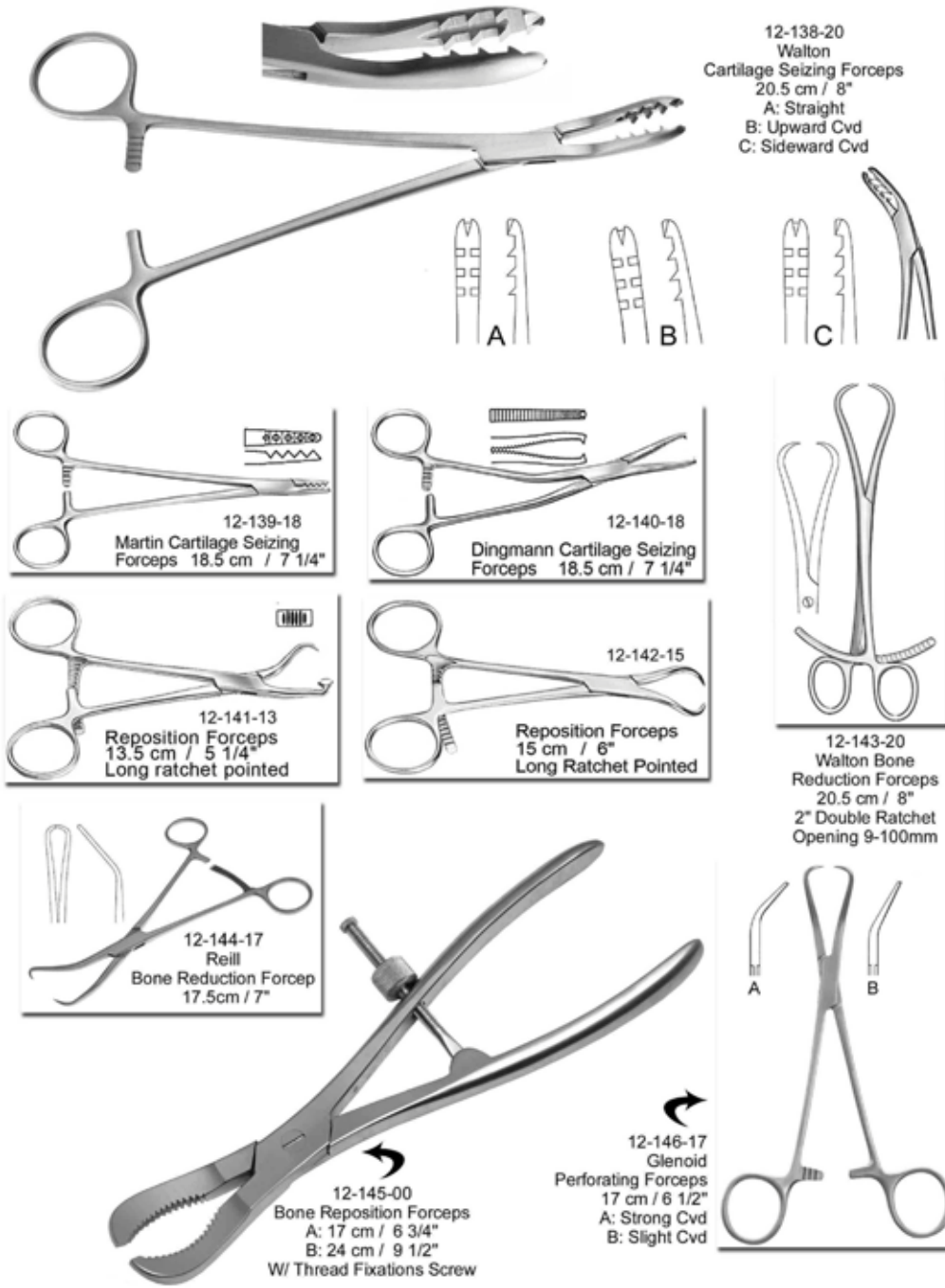

Bone Holding Forceps

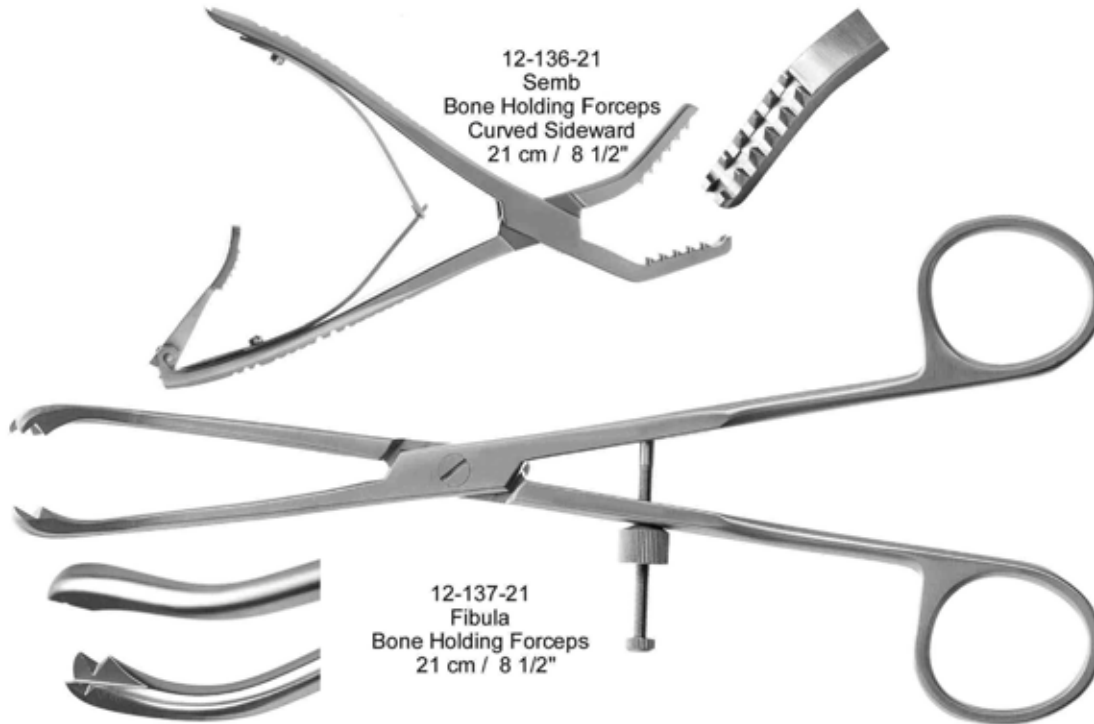

Bone Holding Forceps

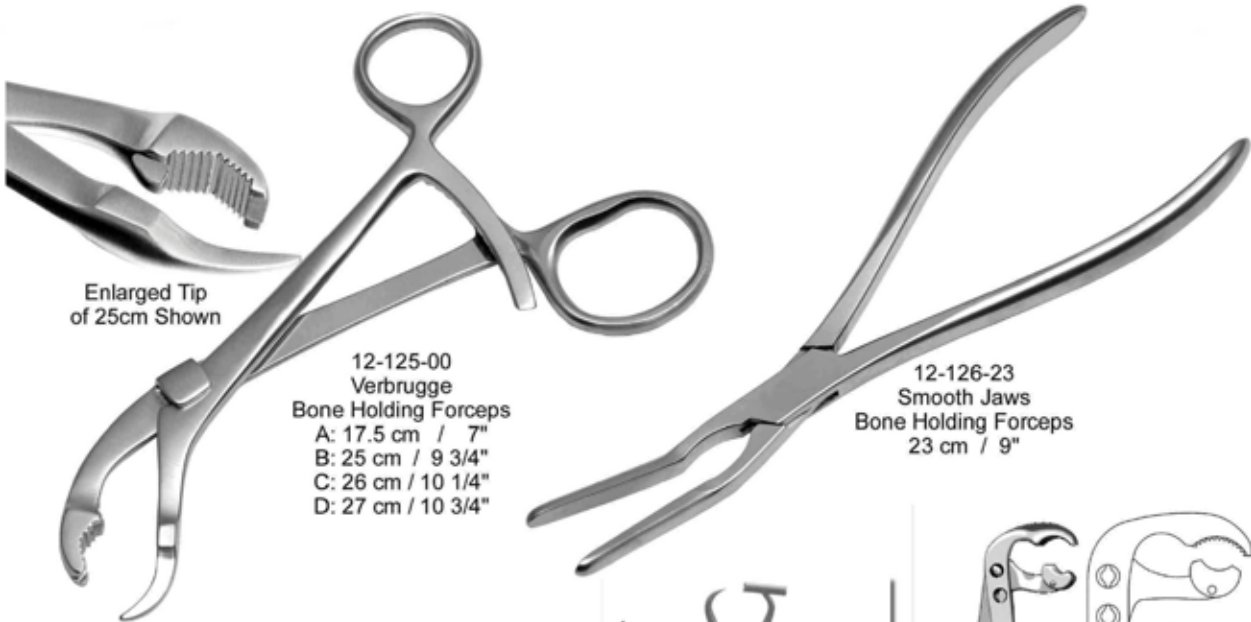

Enlarged Tip
of 25cm Shown

12-125-00
Verbrugge
Bone Holding Forceps
A: 17.5 cm / 7"
B: 25 cm / 9 3/4"
C: 26 cm / 10 1/4"
D: 27 cm / 10 3/4"

12-126-23
Smooth Jaws
Bone Holding Forceps
23 cm / 9"

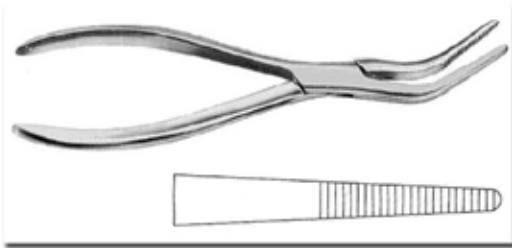

12-127-21
Van Buren Bone Holding Forceps 21.5 cm / 8 1/2"

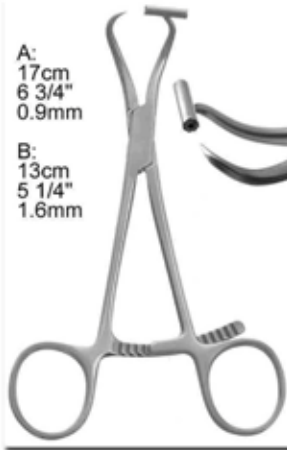

A:
17cm
6 3/4"
0.9mm
B:
13cm
5 1/4"
1.6mm

Swivel Head
Adjustable Jaws

12-129-23
Angled Bone Holding Forceps
23 cm / 9"



12-130-23
Bishop Bone Holding Forceps
23 cm / 9"

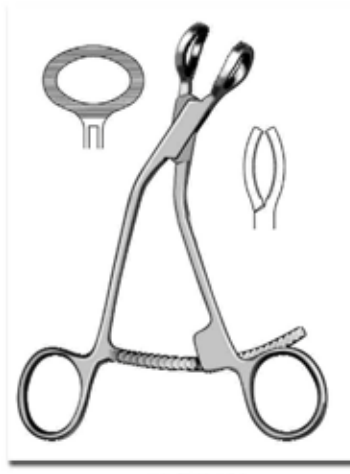

12-131-23
Bishop Bone Holding Forceps
23 cm / 9"



1X2 Prong

2X2 Prong

12-132-18
Patella Forceps
18 cm / 7"

Bone Holding Forceps

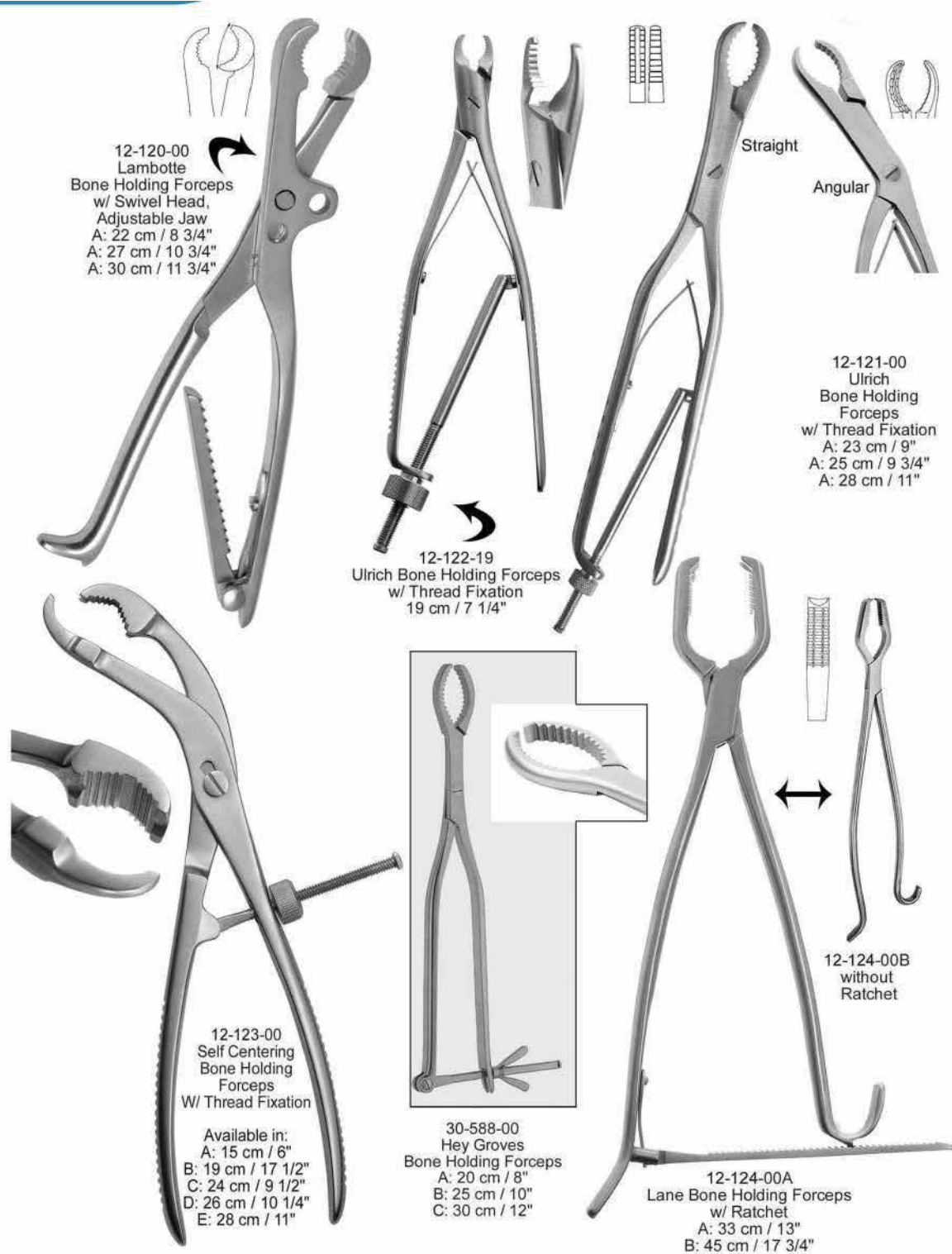

Bone Holding Forceps

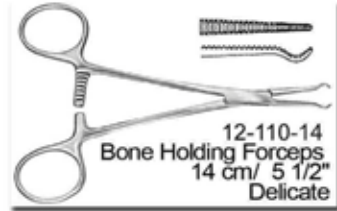
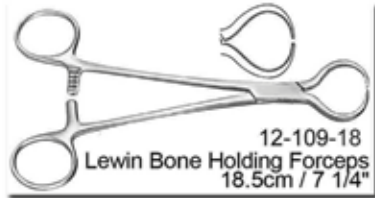
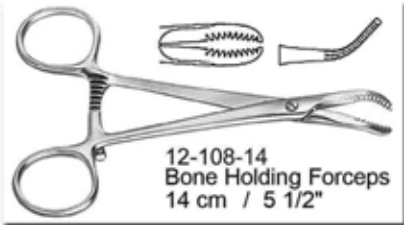

12-111-18 Frosch Bone
Holding Forceps 18 cm / 7"

12-112-20 Bone Holding
Forceps 20 cm / 8"

12-113-19 Semb Bone Holding
Forceps 19 cm / 7 1/2"

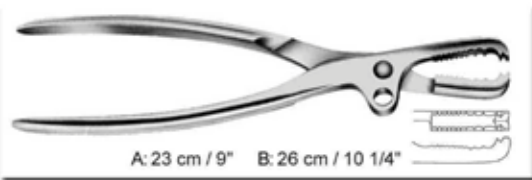
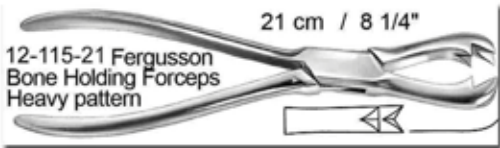
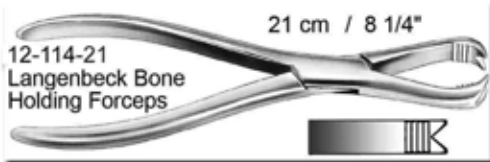

12-117-00
Kern Bone Holding Forceps
A: 17 cm / 6 3/4"
B: 21 cm / 8 1/4"

12-116-00
Farabeuf Bone Holding Forceps

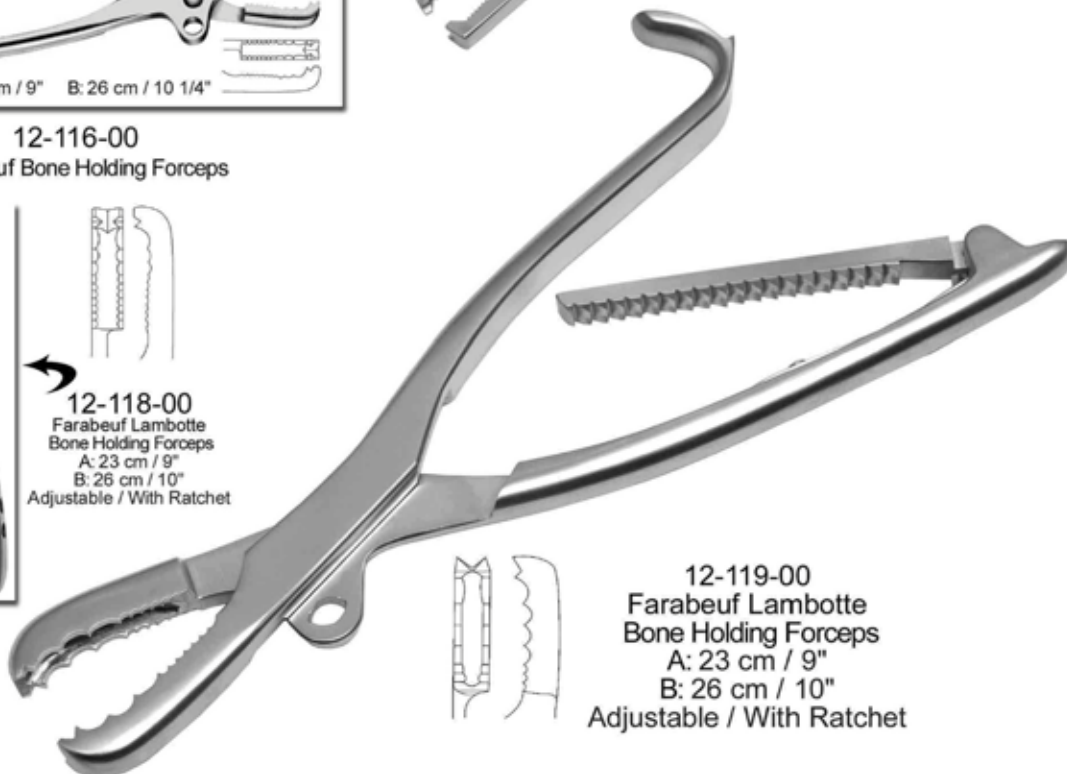

12-119-00
Farabeuf Lambotte
Bone Holding Forceps
A: 23 cm / 9"
B: 26 cm / 10"
Adjustable / With Ratchet

Pelvic Reduction Forceps

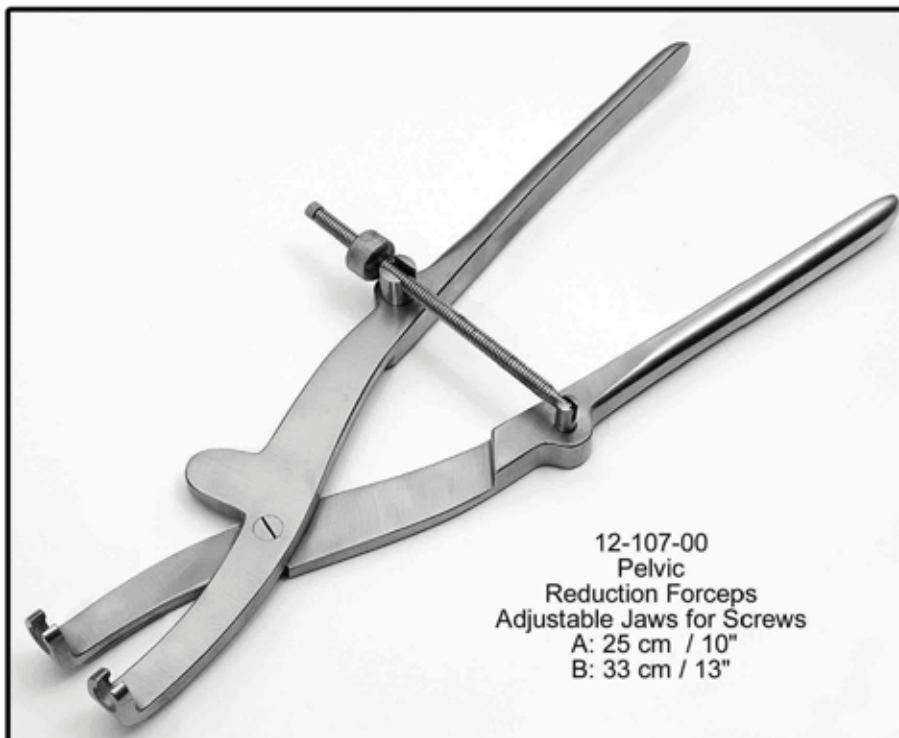
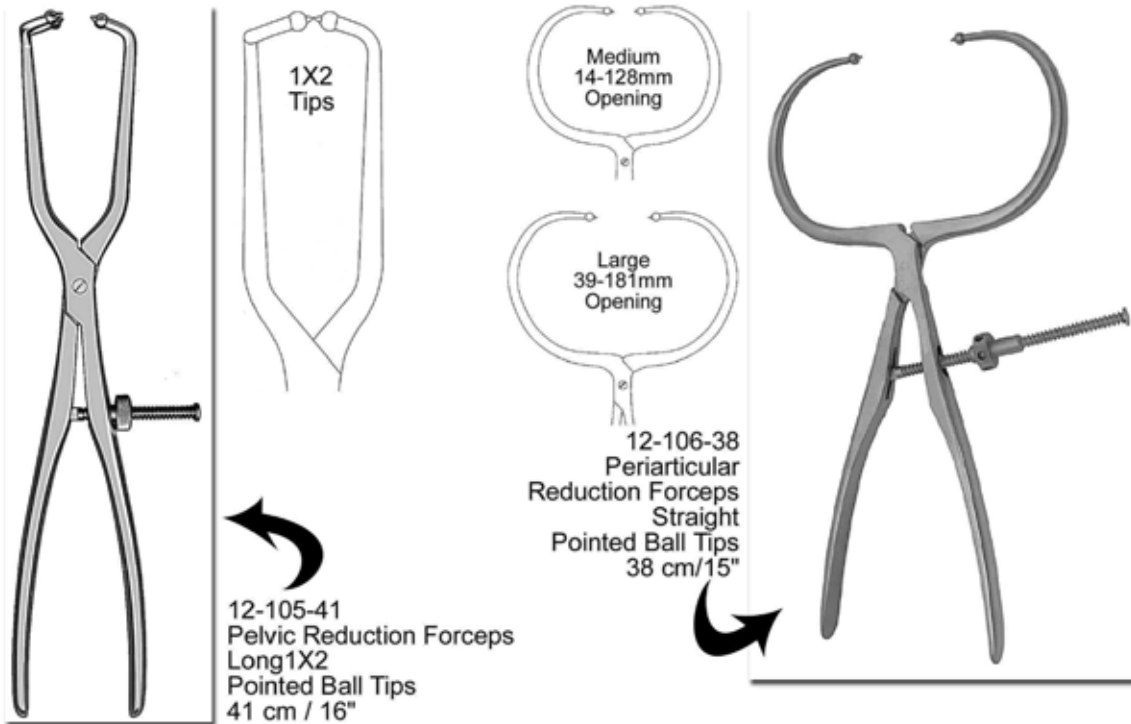

Pelvic Reduction Forceps

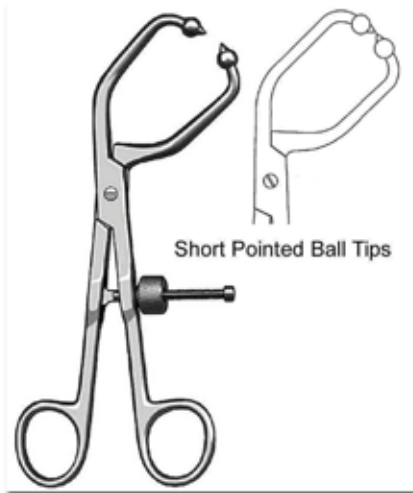

12-100-19 Pelvic Reduction Forceps
19 cm / 7 3/8" Angular

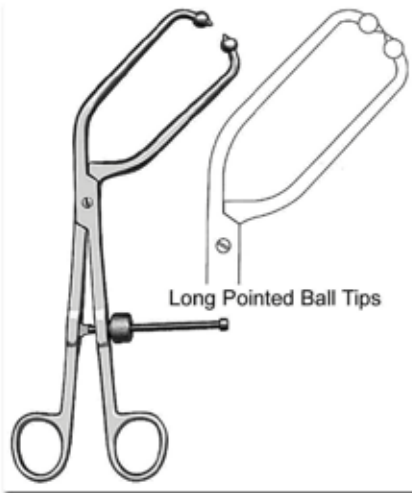

12-101-24 Pelvic Reduction Forceps
24.5 cm / 9 5/8" Angular

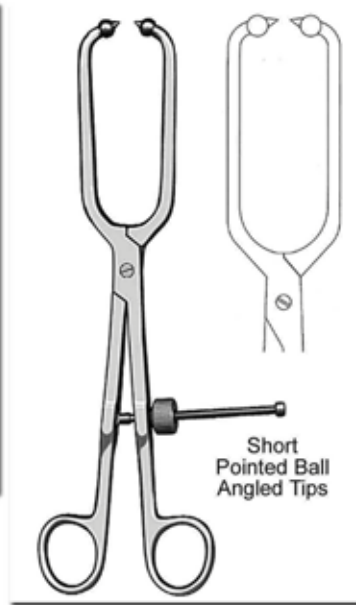

12-102-25 Pelvic Reduction Forceps
25 cm / 10"

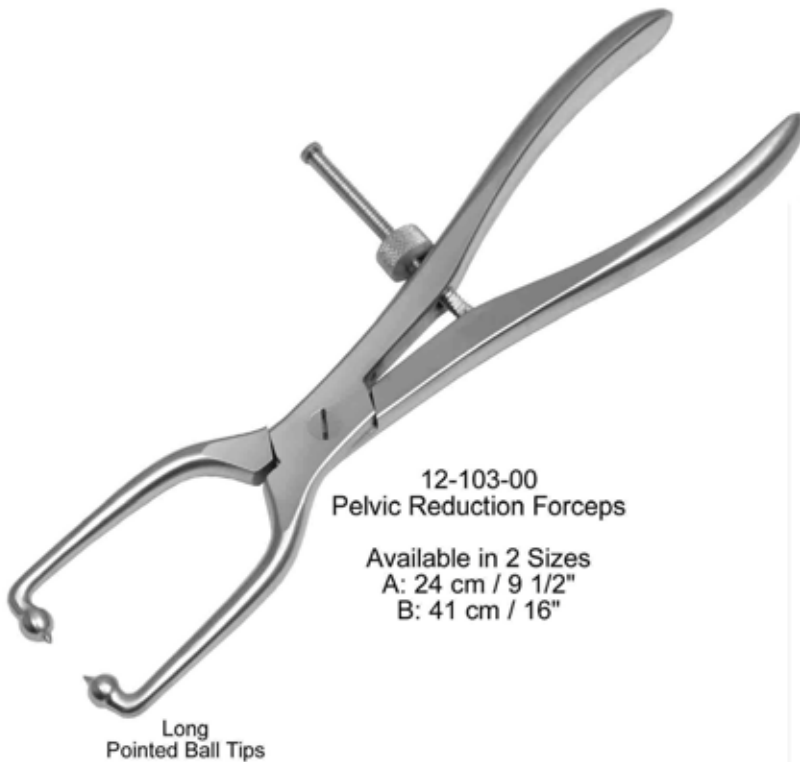

12-103-00 Pelvic Reduction Forceps

Available in 2 Sizes
A: 24 cm / 9 1/2"
B: 41 cm / 16"

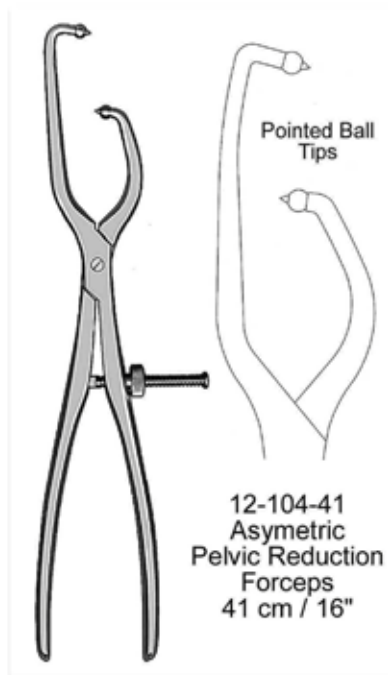

12-104-41 Asymmetric Pelvic Reduction Forceps
41 cm / 16"

Miscellaneous Instruments



11-617-13
Meniscus Clamp
13.5 cm / 5 3/8" 1X2 teeth

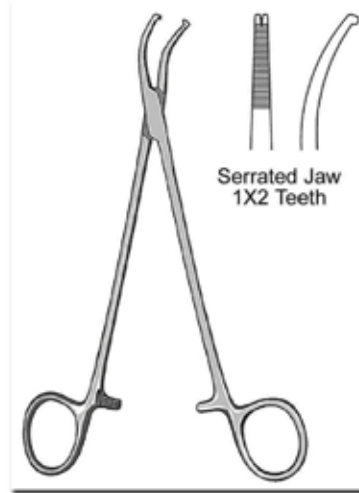

11-618-18
Preston Ligamentum Flavum Forceps
(Meniscus) 18.5 cm / 7 1/4"

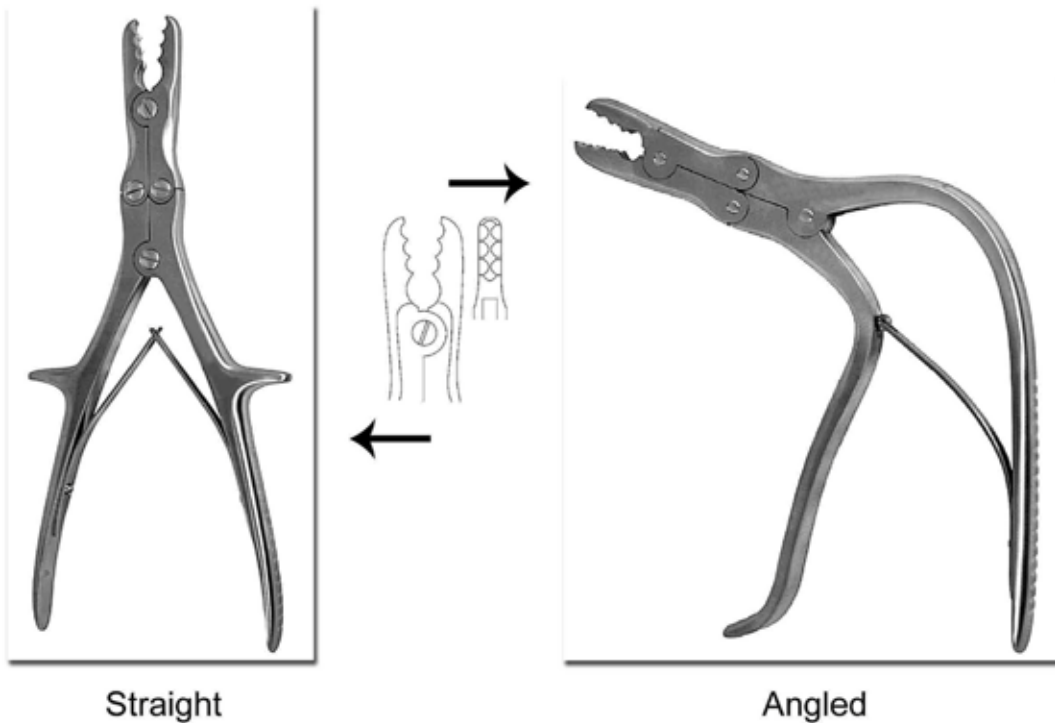

Straight

Angled

11-619-21
Ortho Grasper 21 cm / 8 1/2"
7 X 20 MM Bite

Tendon Instruments

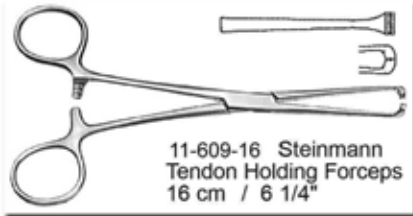

11-609-16 Steinmann
Tendon Holding Forceps
16 cm / 6 1/4"

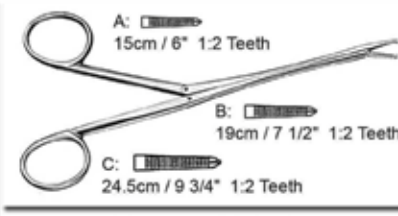

11-610-00 A / B / C
Brand Tendon Tunnelling Forceps



11-611-11
Tendon Holding Forceps
11.5 cm / 4 1/2"

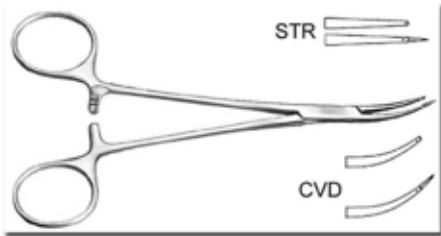

11-612-15 Tendon Interlacing Forceps
15.5 cm / 6" Pointed

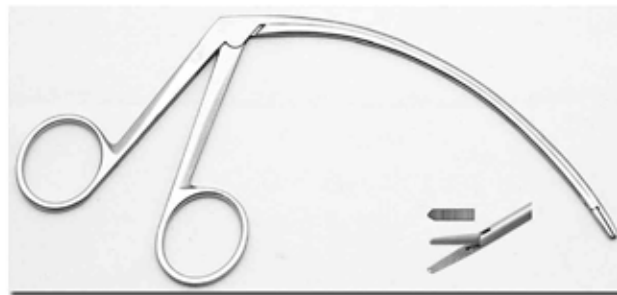

11-613-11
Carroll Tendon Holding Forceps 11.5 cm / 4 1/2"

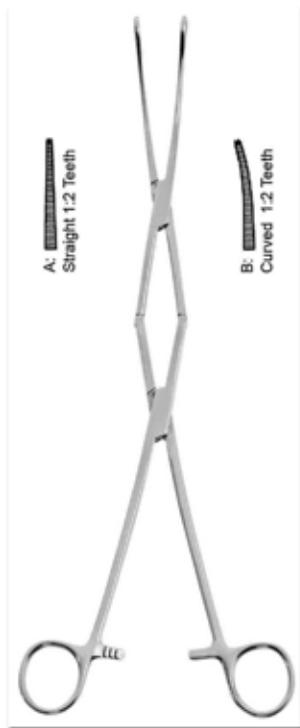

11-614-21
Hallman Tendon Tunnelling Forceps
21 cm / 8 1/4"

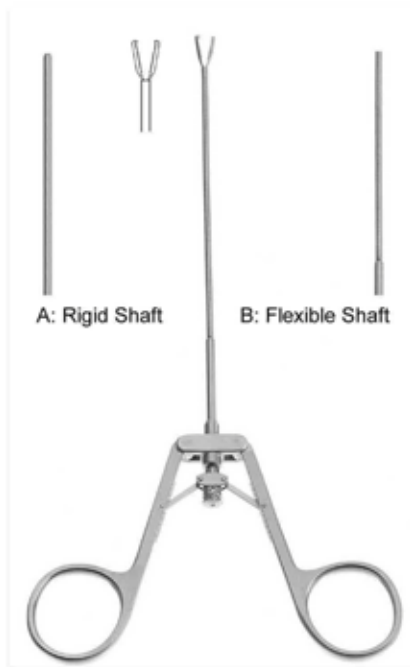

11-615-21
Kleinert-Kutz Tendon Holding Forceps
21 cm / 8 1/4" 1X2 teeth



11-616-14
Hoen Grasping Forceps
14 cm / 5 1/2" (Shaft)
1X2 teeth

Meniscus-Tendon-Cartilage Instruments

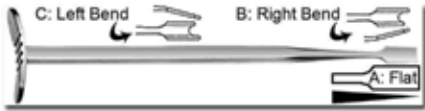

11-594-18 Smillie Meniscus Knife 18 cm / 7"



11-595-18 Meniscus Knife 18 cm / 7"

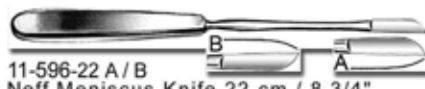

11-596-22 A / B
Neff Meniscus Knife 22 cm / 8 3/4"



11-597-21 A / B Salenius Meniscus Knife
21 cm / 8 1/4" A: Right / B: Left



11-598-15 Bunnell Tendon Stripper 15 cm / 6"
3mm 4mm 5mm 6mm 7mm



11-599-23
Tendon Stripper
23 cm / 9"
Flexible shaft

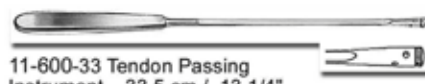

11-600-33 Tendon Passing Instrument 33.5 cm / 13 1/4"

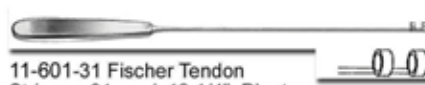

11-601-31 Fischer Tendon Stripper 31 cm / 12 1/4" Blunt



11-602-28 Tendon Stripper 3 / 4 / 5 / 6mm
A: 28.5 cm / 11 1/4" B: 60 cm / 24"

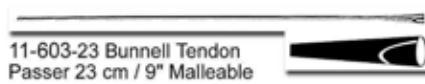

11-603-23 Bunnell Tendon Passer 23 cm / 9" Malleable



11-604-28 Tendon Stripper 40 cm / 16"
Fibre Handle

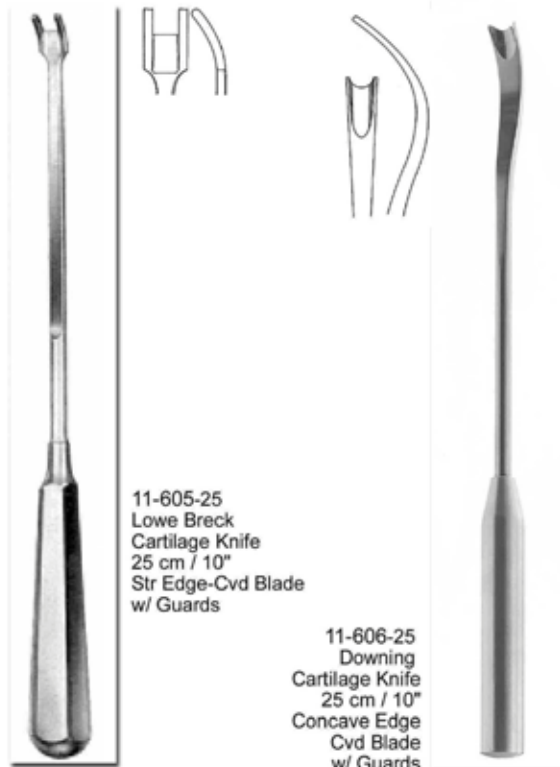

11-605-25
Lowe Breck
Cartilage Knife
25 cm / 10"
Str Edge-Cvd Blade
w/ Guards

11-606-25
Downing
Cartilage Knife
25 cm / 10"
Concave Edge
Cvd Blade
w/ Guards

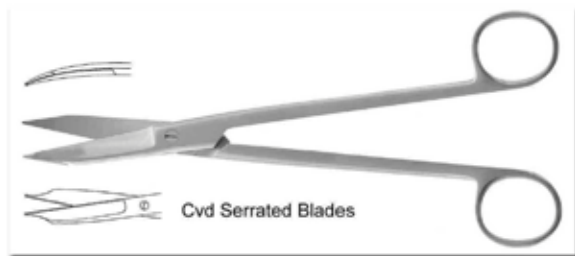

11-607-20 Martin Cartilage Scissors 20cm / 8"

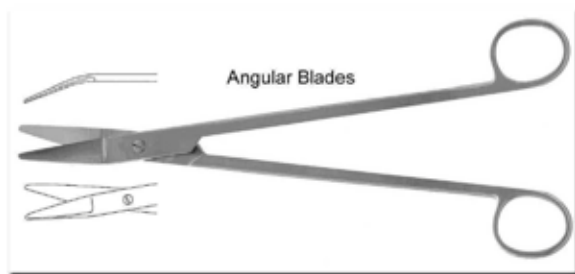

11-608-24 Mueller Capsule Scissors 24cm / 9 1/2"

Orthopedic Mallets-SS-Fiber

Note: Handle Shown In Dark Colors are Made of FIBRE Material

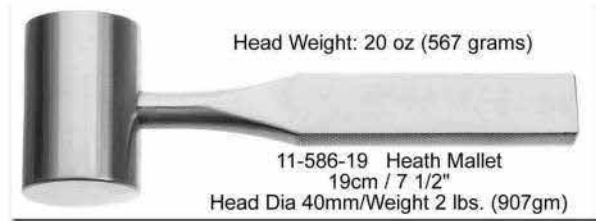

Orthopedic Mallets-SS-Fiber

Note: Handle Shown In Dark Colors are Made of FIBRE Material

11-564-19 Lucae Mallet 19.5cm / 7 3/4"

Available in 2 sizes
19mm Ø / 230 gms
25mm Ø / 260 gms

11-565-19 Cottle Mallet Plane / Convex

19cm / 7 1/2" 30mm Ø / 300 gms

11-566-16 20mm Ø / 140 gms

Williger Mallet

16.4cm / 6 1/2"

11-567-26 Mallet 26 cm / 10 1/4"

30mm Ø / 510 gms

11-568-19 Mead Mallet
19 cm / 7 1/2"

27mm Ø / 320 gms

with interchangeable plastic disks

11-569-19 Partsch Mallet

22mm Ø / 200 gms

19 cm / 7 1/2" with hollow handle

11-570-26 Mallet 26 cm / 10 1/4"

with lead filling

Also available without lead filling
42mm Ø / 400 gms

11-571-26 Mallet
26 cm / 10 1/4"

without lead filling
42mm Ø / 400 gms

11-572-24 Williger Mallet

24 cm / 9 1/2" lead filled

Available Head Sizes & Approximate Weight
26mm Ø / 300 gms 28mm Ø / 340 gms
30mm Ø / 400 gms

11-573-26 Mallet 30mm Ø / 675 gms
26.5 cm / 10 1/2"

plane (Teflon) / convex (steel)

11-574-26 Mallet 26 cm / 10 1/4"

42 / 30mm Ø / 530 gms

11-575-24 Mallet 24 cm / 9 1/2"

30mm Ø / 480 gms

11-576-24 Mallet 24 cm / 9 1/2"
Disks and handle of Fiber

37mm Ø / 370 gms

Spare facings (Pair)

11-577-22 30mm Ø / 125 gms

Mallet 22 cm / 8 3/4"

11-578-26 Mallet 26.5 cm / 10 1/2"

30mm Ø / 450 gms

11-579-20 A/B/C Doyen Mallet

Available Length / Head Sizes & Approximate Weight

A: 20.5cm / 8" 25mm Ø / 120 gms
B: 21cm / 8 1/4" 30mm Ø / 180 gms
C: 21.5cm / 8 1/2" 35mm Ø / 260 gms

11-580-19 Herbert Mallet
19 cm / 7 1/2"

for ulnar head prosthesis



Elevators Spinal-SS and Fiber

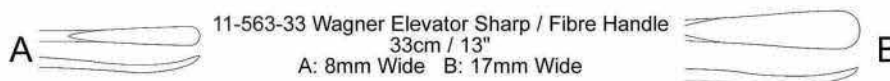
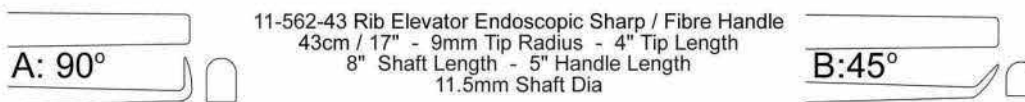
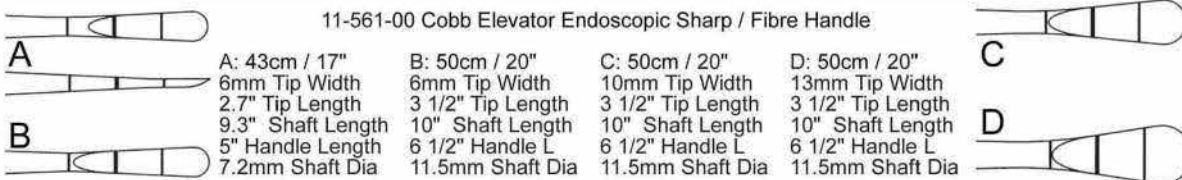
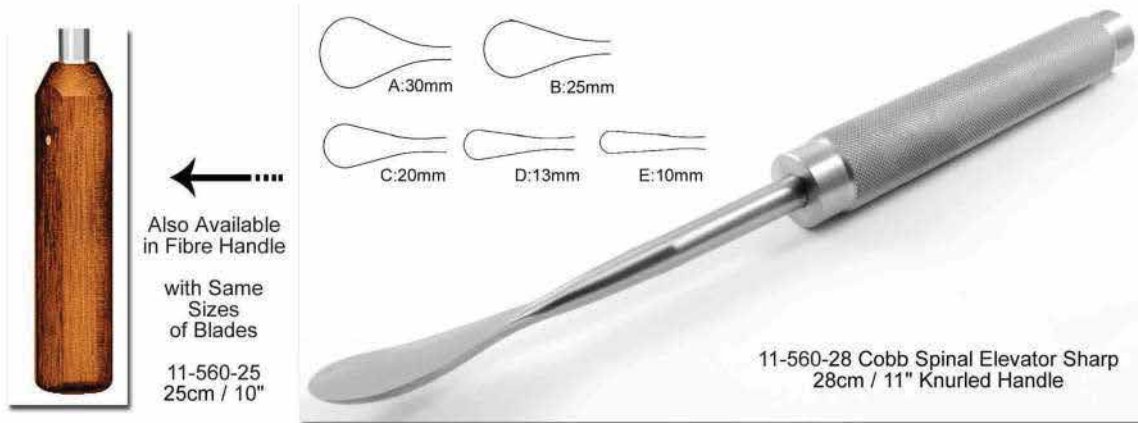
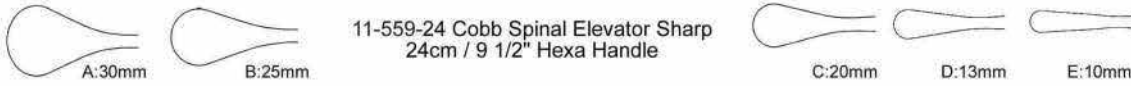

Periosteal Elevators

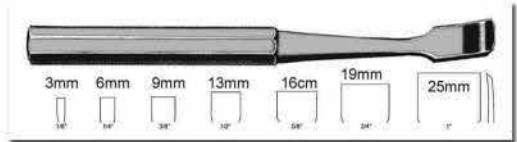

11-549-19 Key Elevator 19 cm / 7 1/2" Sharp Edge

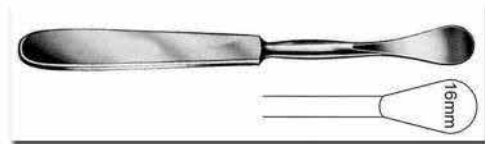

11-550-18 Sedilot Elevator 18 cm / 7" Sharp Edge



11-551-20 Alexander Periosteal Respiratory
20 cm / 8" / 12mm Sharp

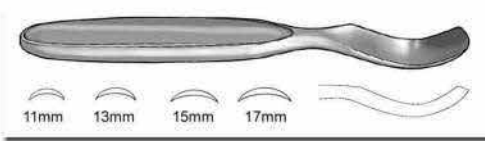

11-552-16 McGlamry Metatarsal Elevator
16 cm / 6 1/2" Sharp



11-553-16 Sayre Elevator 16 cm / 6 1/2"
A: Sharp / Blunt B: Blunt / Blunt



11-554-17 Kirmission Periosteal Respiratory 17 cm / 6 3/4"



11-555-17 Periosteal Elevator
17 cm / 6 3/4"
Fibre Handle 13mm Blade Sharp



11-556-19 Crego Periosteal Elevator
19 cm / 7 3/4" Sharp
A: 14mm Full Curves B: 14mm Slight Curves
C: 7mm Full Curves D: 7mm Slight Curves



11-557-00 Chandler Elevator Blunt

A: 19cm / 7 1/2" 13mm B: 20cm / 8" 19mm
C: 23cm / 9" 25mm D: 25.5cm / 10" 30mm

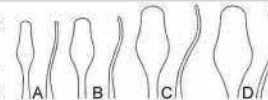





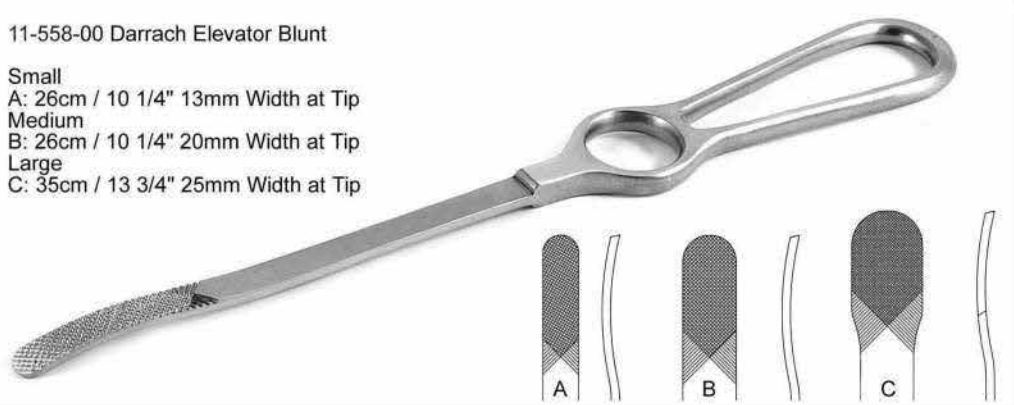

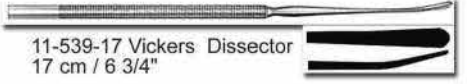

11-558-00 Darrach Elevator Blunt

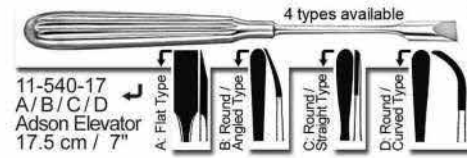
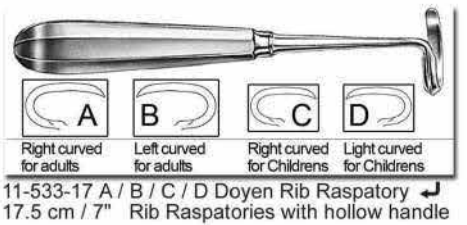
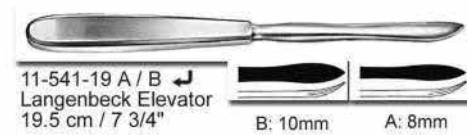
Small
A: 26cm / 10 1/4" 13mm Width at Tip
Medium
B: 26cm / 10 1/4" 20mm Width at Tip
Large
C: 35cm / 13 3/4" 25mm Width at Tip

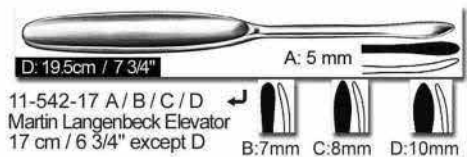
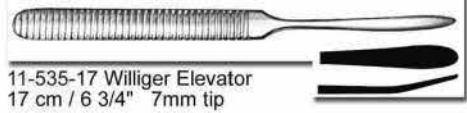

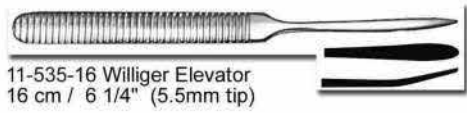
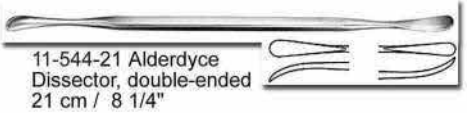
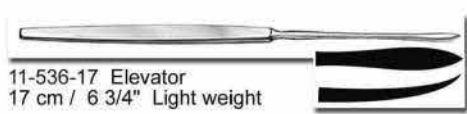
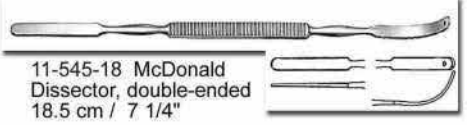
Periosteal Elevators

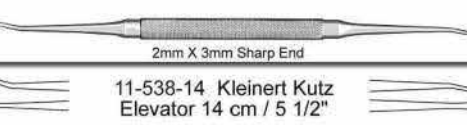
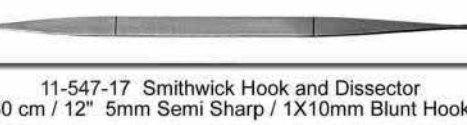
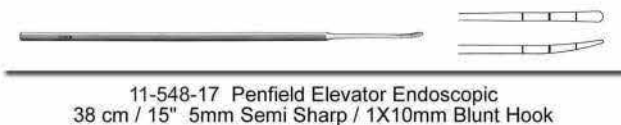
 <p>11-531-20 Periosteal Elevator 20 cm / 8" with plastic handle 19 mm Tip</p>	 <p>11-539-17 Vickers Dissector 17 cm / 6 3/4"</p>
 <p>11-532-17 A / B Periosteal Elevator 17 cm / 6 3/4" with hollow handle B: 8 mm Tip A: 6 mm Tip</p>	 <p>11-540-17 A / B / C / D Adson Elevator 17.5 cm / 7" 4 types available A: Flat Type B: Round / Angled Type C: Round / Straight Type D: Round / Curved Type</p>
 <p>11-533-17 A / B / C / D Doyen Rib Raspatory 17.5 cm / 7" Rib Raspatories with hollow handle A: Right curved for adults B: Left curved for adults C: Right curved for Childrens D: Light curved for Childrens</p>	 <p>11-541-19 A / B Langenbeck Elevator 19.5 cm / 7 3/4" B: 10mm A: 8mm</p>
 <p>11-534-18 West Periosteal Elevator, double-ended 18.5 cm / 7 1/4" octagonal handle</p>	 <p>11-542-17 A / B / C / D Martin Langenbeck Elevator 17 cm / 6 3/4" except D A: 5 mm D: 19.5cm / 7 3/4" B: 7mm C: 8mm D: 10mm</p>
 <p>11-535-17 Williger Elevator 17 cm / 6 3/4" 7mm tip</p>	 <p>11-543-16 Phalangeal Elevator 16 cm / 6 1/4"</p>
 <p>11-535-16 Williger Elevator 16 cm / 6 1/4" (5.5mm tip)</p>	 <p>11-544-21 Alderdyce Dissector, double-ended 21 cm / 8 1/4"</p>
 <p>11-536-17 Elevator 17 cm / 6 3/4" Light weight</p>	 <p>11-545-18 McDonald Dissector, double-ended 18.5 cm / 7 1/4"</p>
 <p>11-537-14 McKenty Elevator 14 cm / 5 1/2" Semi Sharp 4mm 5mm</p>	 <p>11-546-17 Freer Elevator 19 cm / 7 1/2"</p>
 <p>11-538-14 Kleinert Kutz Elevator 14 cm / 5 1/2" 2mm X 3mm Sharp End</p>	 <p>11-547-17 Smithwick Hook and Dissector 30 cm / 12" 5mm Semi Sharp / 1X10mm Blunt Hook</p>
 <p>11-548-17 Penfield Elevator Endoscopic 38 cm / 15" 5mm Semi Sharp / 1X10mm Blunt Hook</p>	

Periosteal Elevators

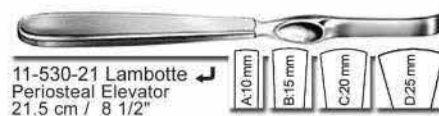
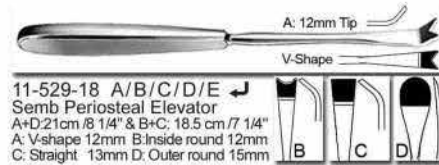
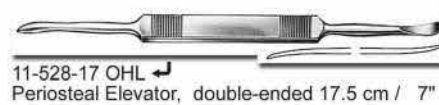
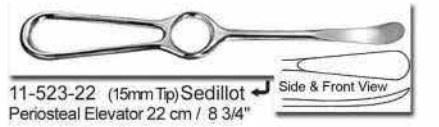
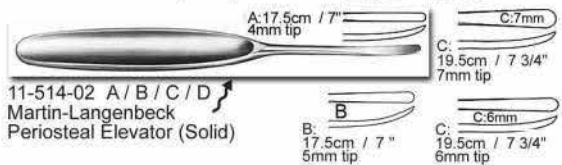
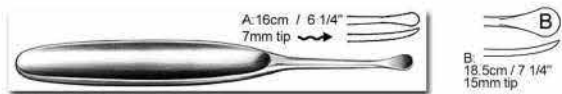
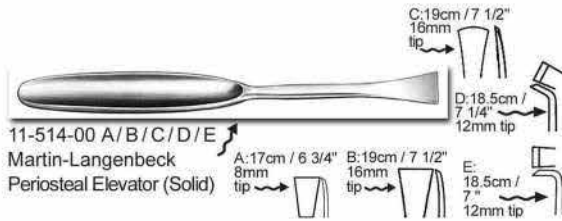

Bone Currettes

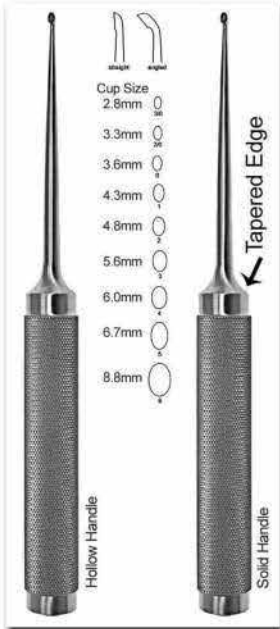

11-508-28A
Cobb Curette Oval Cups
28 cm / 11"

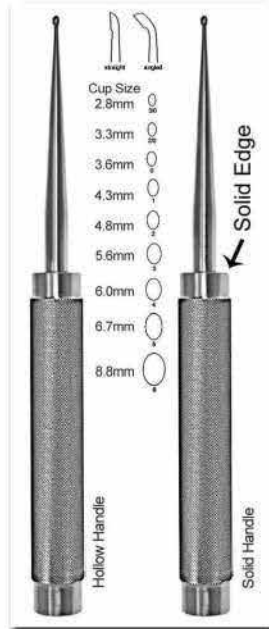

11-508-28B
Cobb Curette Oval Cups
28 cm / 11"



11-509-00
Sypert Curette Long Delicate Shaft



11-510-23
Cone Ring Curette
23 cm / 9"



11-511-34 Zielke Ring Curette 34 cm / 13 1/2" TEFLON Handle



17" Angled 40°
3mm Diameter
2.7" Tip Length
9.3" Shaft Length
5" Handle Length
.285 (7.2mm)
Shaft Diameter



11-512-00 Cone Ring Curette Endoscopic Fibre Handle



20" Angled 30°
6mm Diameter
3 1/2" Tip Length
10" Shaft Length
6 1/2" Handle Length
.45" (11.5mm)
Shaft Diameter



17" Reverse
Angled 40°
3mm x 6mm cup
2.7" Tip Length
9.3" Shaft Length
5" Handle Length
.285 (7.2mm)
Shaft Diameter



11-513-00 Epstein Curette Endoscopic Fibre Handle



20" Reverse
Angled 30°
6mm x 9mm cup
3 1/2" Tip Length
10" Shaft Length
6 1/2" Handle Length
.45 (7.2mm)
Shaft Diameter

Bone Curettes

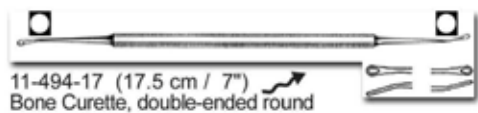

11-494-17 (17.5 cm / 7")
Bone Curette, double-ended round



11-495-18 A / B / C Hemingway
Bone Curette, double-ended,
round / round 18.5 cm / 7 1/4"
octagonal handle

Available in 3 sets of
same order faces
A: 00/00 ● / ●
B: 0/0 ● / ●
C: 1/1 ● / ●



11-496-18 A / B / C / D
Lucas Bone Curette,
double-ended
18 cm / 7"
octagonal handle

Available in 4 sizes
A: 1 R/L
B: 2 R/L
C: 3 R/L
D: 4 R/L



11-497-17 A / B / C / D / E
Miller-Colburn Bone Curette,
double-ended 17 cm / 6 3/4"

Available in 5 sizes
A
B
C
D
E



11-498-17 A / B / C / D / E
Molt Bone Curette
17 cm / 6 3/4"

Available in 5 sizes
A B C D E

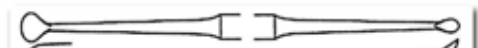

11-499-19
Molt Bone Curette
19 cm / 7 1/2" Round Handle

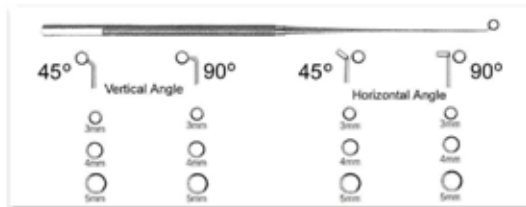

11-500-18
Ray Pituitary Curette 18 cm / 7 1/2"

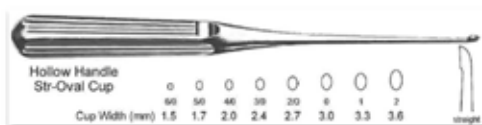

11-501-18 Lempert Curette 18 cm / 7 1/2"

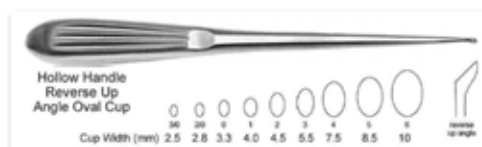

11-502-18 Epstein Curette 18 cm / 7 1/2"



11-503-25 Bushe Curette 25 cm / 10"

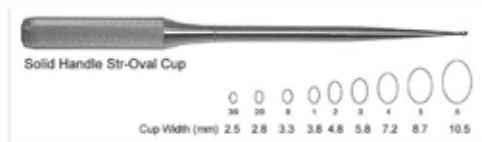

11-504-28 Spinal Fusion Curette 28 cm / 11"

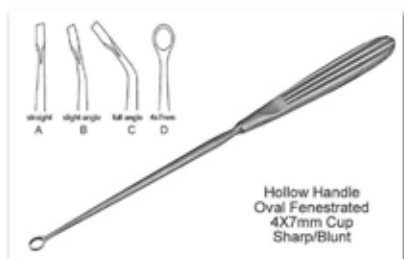

11-505-23
Semmes Ring Curette
23 cm / 9"



11-506-25
Scoville Curette
25 cm / 10"



11-507-00 Ring Curette
A: 25 cm / 10" #0 6mm Cup
B: 25 cm / 10" #2 8mm Cup
C: 26 cm / 10 1/2" #6 14mm Cup
D: 28 cm / 11 1/2" #0 6mm Cup
E: 28 cm / 11 1/2" #2 8mm Cup
F: 30 cm / 12 1/2" #6 14mm Cup

Bone Curettes



Available Sizes: 0000 0000 000 00 01

11-478-18 (18.5 cm / 7 1/4")
Volkmann Bone Curette
oval with plastic handle

2 3 4 5 6



11-478-27 (27.5 cm / 10 3/4")
Volkmann Bone Curette
oval with plastic handle

0 1 2 3



11-479-00 A / B / C
Volkmann Bone Curette,
double-ended (oval / round).

Available in 3 sizes (Length)
A: 13 cm / 5"
B: 16 cm / 6 1/4"
C: 20 cm / 8"



11-486-23 Bruns Bone Curette
23 cm / 9" oval, solid

2 3 4 5



11-480-21 Bone Curette,
double-ended (round / oval) 21 cm / 8 1/4"



11-487-25 A / B / C
Scoville Bone Curette
25 cm / 9 3/4"
oval, with hollow handle

A B C



11-481-17 Schede Bone Curette
17 cm / 6 3/4" oval with hollow handle

000 00 01 2 3 4



11-488-25 Simon Bone Curette
25 cm / 9 3/4"
oval, with hollow handle

1 2 3 4 5 6



11-482-17 Volkmann Bone Curette
17 cm / 6 3/4" oval, with hollow handle

00000 0000 000 00 01



11-489-16 Modell USA
Bone Curette 16 cm / 6 1/4"
Oval, with hollow handle

1 2 3 4 5 6



11-483-17 Bruns Bone Curette
17 cm / 6 3/4" Round, with hollow handle

00000 0000 000 00 01



11-489-15A Modell USA
Bone Curette 15.5 cm / 6"
Oval, with hollow handle

1 2 3 4 5 6



11-484-17
Spratt Bone Curette
17 cm / 6 3/4"
Oval, with hollow handle

00000 0000 000 00 01



11-489-15B Modell USA
Bone Curette 15.5 cm / 6"
Oval, with hollow handle

1 2 3 4 5 6



Available in 3 sets of combination

11-485-13 A / B / C
Williger Bone Curette,
double-ended 13.5 cm / 5 1/4"

A: 00/0 ● / ●
B: 0/1 ● / ●
C: 1/2 ● / ●



11-490-21 Halle Bone Curette
21 cm / 8 1/4" oval, malleable shaft,
with hollow handle

1 2 3



11-485-17 A / B / C Williger
Bone Curette, 17 cm / 6 3/4"
double-ended oval / oval

A: 00/00 ● / ●
B: 0/0 ● / ●
C: 1/1 ● / ●



11-492-18 A / B / C
Hemingway-Martin
Bone Curette, double-ended
18.5 cm / 7 1/4"
octagonal handle oval / oval

Available in 3 sets of
same order faces
A: 1 R/L ● / ●
B: 2 R/L ● / ●
C: 3 R/L ● / ●

For 18cm: 11-493-18 A / B / C (3 same order sets)
Hemingway Bone Curette, double-ended 18 cm / 7"
octagonal handle oval / oval



11-491-00 A / B / C
Volkmann
Bone Curette
double-ended

Available in 3 sizes
(Length)
A: 12.5 cm / 5"
B: 14.5 cm / 5 3/4"
C: 17 cm / 6 3/4"

Chisels-Osteotomes-Gouges



11-468-21
Shoulder Penetrating
Gouge 21cm/8 1/2"



11-469-23
Swan Neck
Gouge 23cm/9"
Handle
Solid
Hexagonal

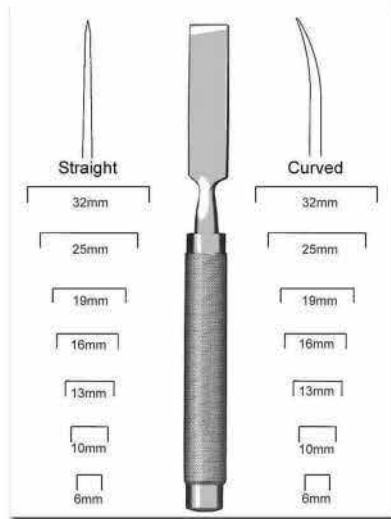

11-470-28
Cobb Osteotome 28cm/11"

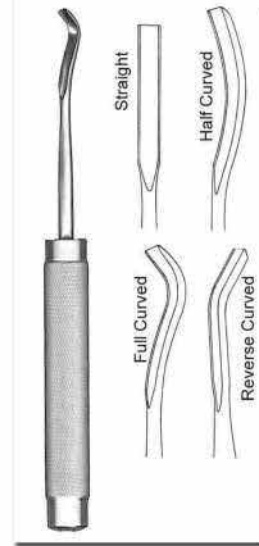

11-471-28
Cobb Gouge 28cm/11"

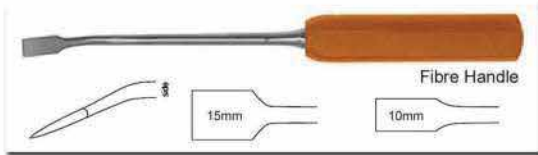

11-472-28 Lexer Osteotome Angled / 28cm/11"



11-473-15 Cinelli Osteotome 15.5cm/6 1/2"

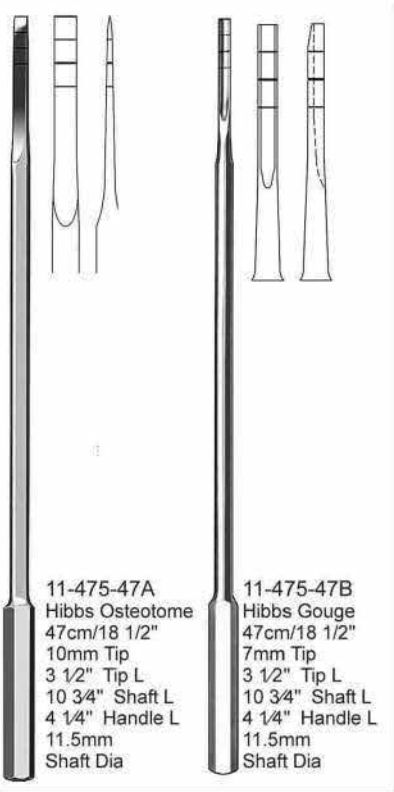

11-475-47A
Hibbs Osteotome
47cm/18 1/2"
10mm Tip
3 1/2" Tip L
10 3/4" Shaft L
4 1/4" Handle L
11.5mm
Shaft Dia

11-475-47B
Hibbs Gouge
47cm/18 1/2"
7mm Tip
3 1/2" Tip L
10 3/4" Shaft L
4 1/4" Handle L
11.5mm
Shaft Dia



11-476-24
Spinal Fusion
Gouge
24cm/9 1/2"
6mm Tip

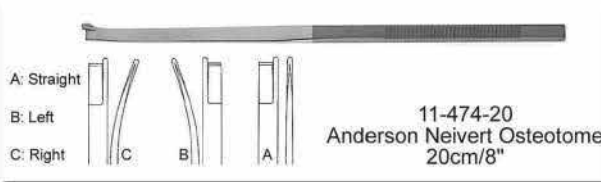

11-474-20
Anderson Neivert Osteotome
20cm/8"

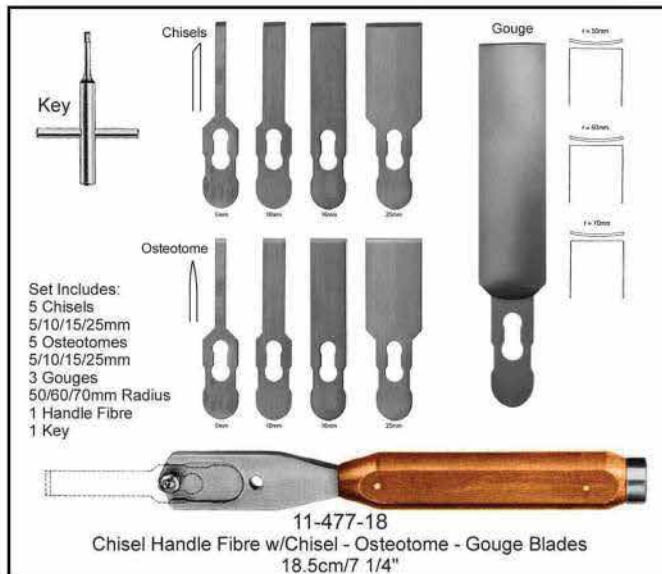

- Set Includes:
5 Chisels
5/10/15/25mm
5 Osteotomes
5/10/15/25mm
3 Gouges
50/60/70mm Radius
1 Handle Fibre
1 Key

11-477-18
Chisel Handle Fibre w/Chisel - Osteotome - Gouge Blades
18.5cm/7 1/4"

Chisels-Osteotomes-Gouges

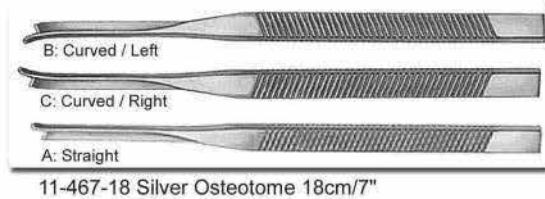
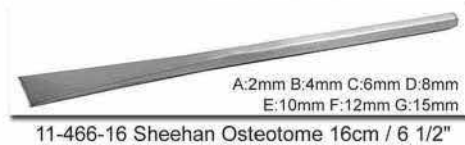
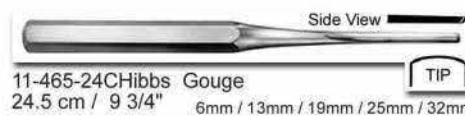
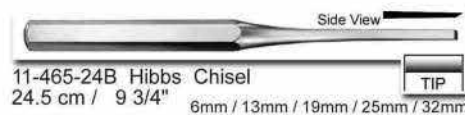
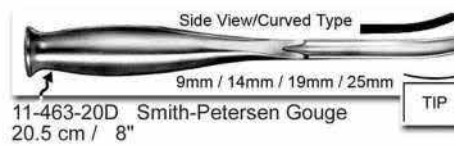
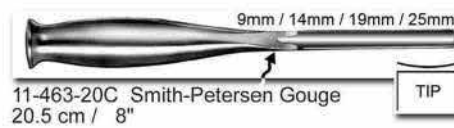
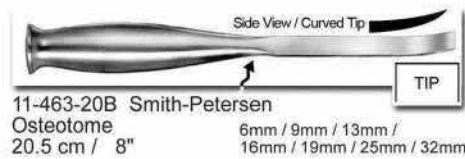
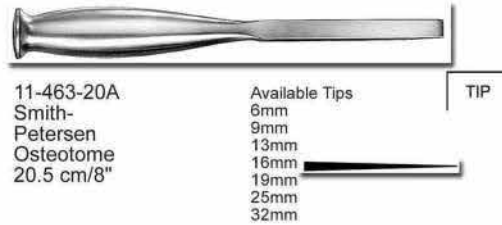
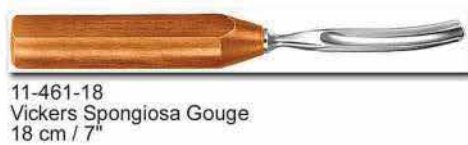
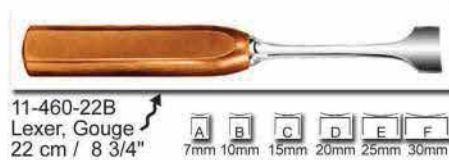
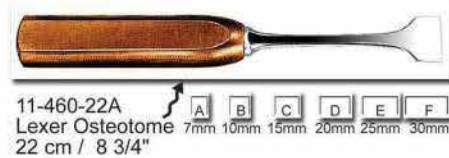
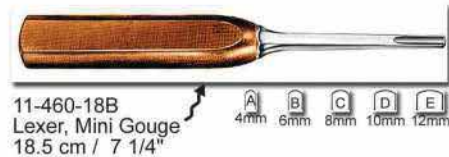
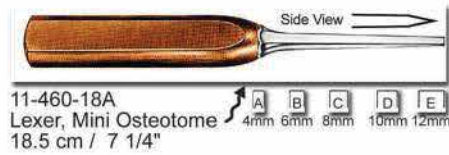
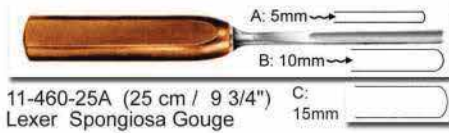

Chisels-Osteotomes-Gouges



11-441-7
Virchow
Skull Breaker
7.5cm / 3"

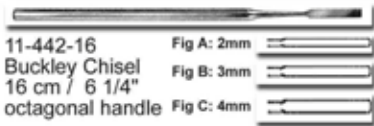

11-442-16
Buckley Chisel
16 cm / 6 1/4"
octagonal handle

Fig A: 2mm
Fig B: 3mm
Fig C: 4mm

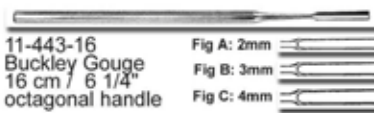

11-443-16
Buckley Gouge
16 cm / 6 1/4"
octagonal handle

Fig A: 2mm
Fig B: 3mm
Fig C: 4mm

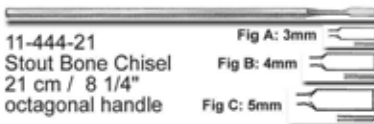

11-444-21
Stout Bone Chisel
21 cm / 8 1/4"
octagonal handle

Fig A: 3mm
Fig B: 4mm
Fig C: 5mm

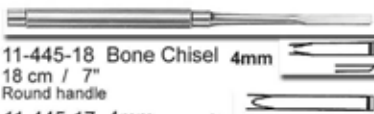

11-445-18 Bone Chisel 4mm
18 cm / 7"
Round handle



11-445-17 4mm
17 cm / 6 3/4"

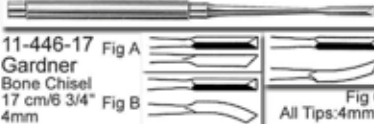

11-446-17 Gardner
Bone Chisel
17 cm / 6 3/4"
4mm

Fig A
Fig B
All Tips: 4mm
Fig C

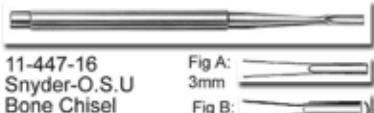

11-447-16
Snyder-O.S.U
Bone Chisel
16.5 cm / 6 1/2"
3 mm / 5 mm

Fig A: 3mm
Fig B: 5mm



11-448-18 Bone Chisel
18 cm / 7" Octagonal Handle 4mm

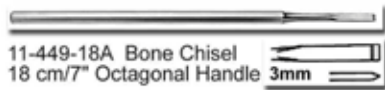

11-449-18A Bone Chisel
18 cm / 7" Octagonal Handle 3mm

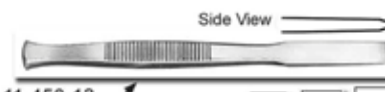

11-450-13
Osteotome
13.5 cm / 5 1/4"

Fig.A 8mm Fig.B 10mm Fig.C 12mm Fig.D 14mm Fig.E 16mm

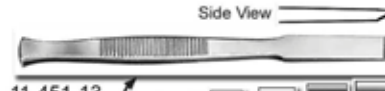

11-451-13
Chisel
13.5 cm / 5 1/4"

Fig.A 8mm Fig.B 10mm Fig.C 12mm Fig.D 14mm Fig.E 16mm

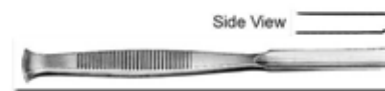

11-452-13
Gouge
13.5 cm / 5 1/4"

Fig.A 8mm Fig.B 10mm Fig.C 12mm Fig.D 14mm Fig.E 16mm

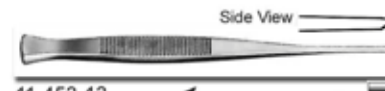

11-453-13
Partsch Chisel
13.5 cm / 5 1/4"
&
17cm / 6 3/4"

Fig.A 2mm Fig.B 3mm Fig.C 4mm Fig.D 5mm Fig.E 6mm

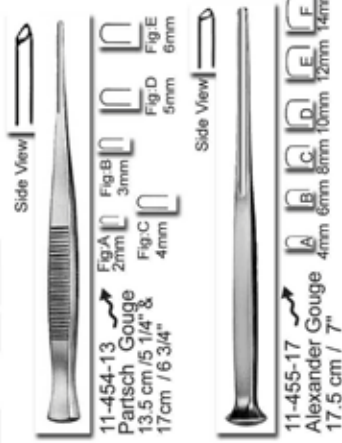

Side View

Fig.A 2mm Fig.B 3mm Fig.C 4mm Fig.D 5mm Fig.E 6mm

Side View

11-455-17 Alexander Gouge
4mm 6mm 8mm 10mm 12mm 14mm

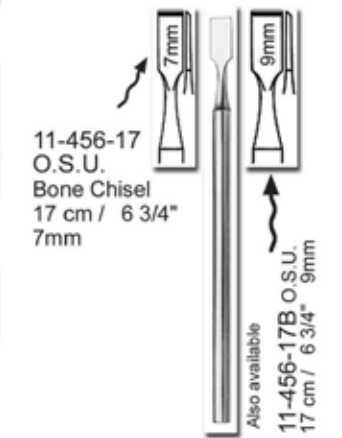

11-456-17
O.S.U.
Bone Chisel
17 cm / 6 3/4"
7mm

Also available

11-456-17B O.S.U.
17 cm / 6 3/4" 9mm

TIP

Three sizes in Lambotte Mini Osteotome (see below)

Available Tip Sizes

Side View

2mm / 3mm / 4mm / 6mm / 8mm / 10mm / 12mm / 15mm

11-457-12 (12.5 cm / 5") Lambotte, Mini Osteotome
15mm / 20mm / 25mm / 30mm / 38mm / 44mm / 50mm

11-457-17 (17 cm / 6 3/4") Lambotte, Mini Osteotome
3mm / 4mm / 6mm / 8mm / 10mm / 12mm / 15mm

11-457-24 (24 cm / 9 1/2") Lambotte, Osteotome
15mm / 20mm / 25mm / 30mm / 38mm / 44mm / 50mm

Other Lambotte Mini Osteotomes sizes / Tips

For Image, please see photo of above Osteotome.

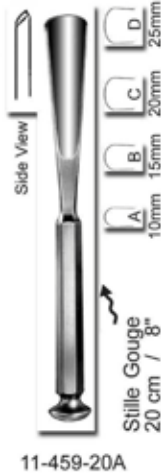

11-459-20A

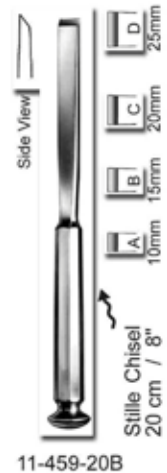

11-459-20B

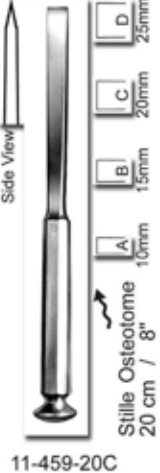

11-459-20C

Bone Levers-Retractors

11-438-00
St. Mark's Pelvic Retractor
Angled Blade

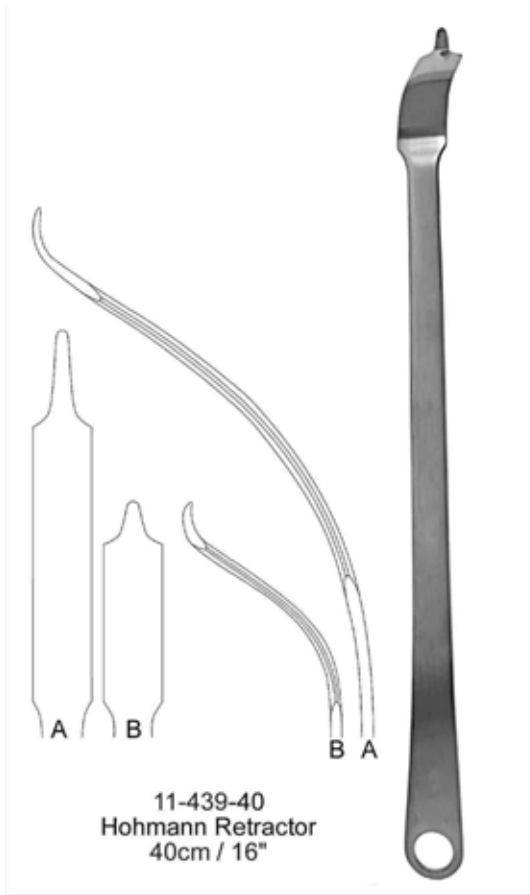
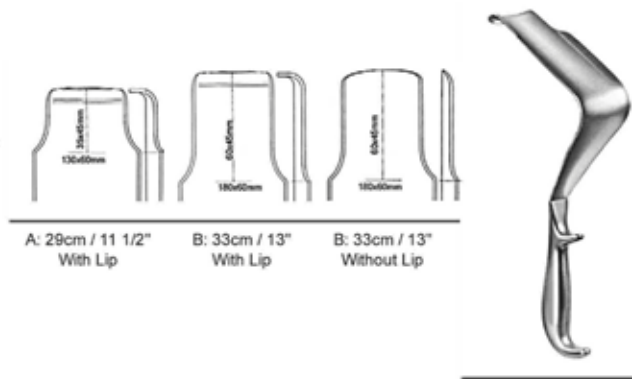

- A: 22mm Blade
2 Finger Rings Long Round → 
- B: 22mm Blade
1 Finger Ring Short Round → 

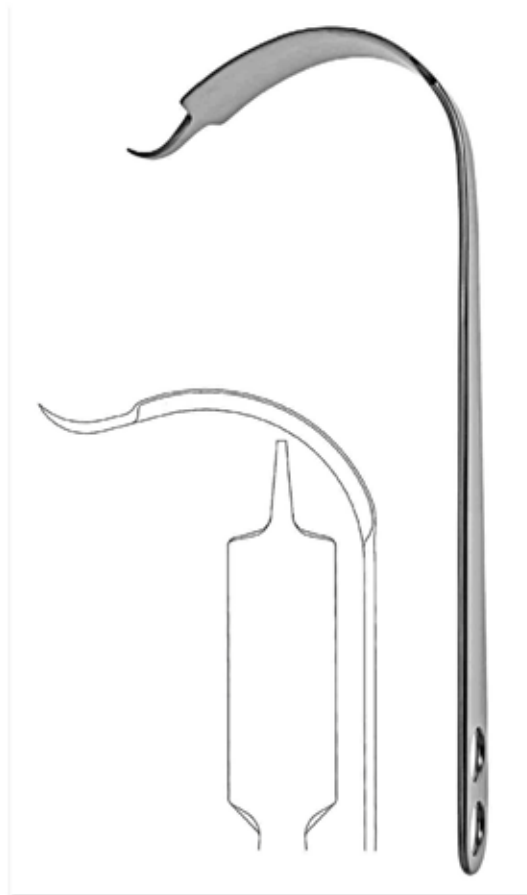

11-440-33
Hohmann Retractor
33cm / 13"
40mm Blade Width

Bone Levers-Retractors

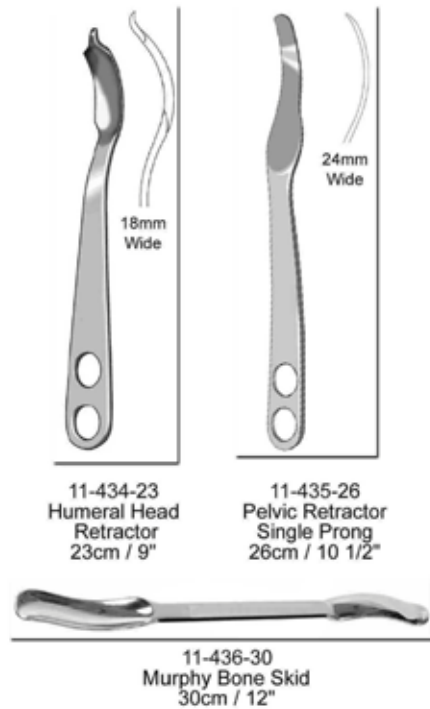
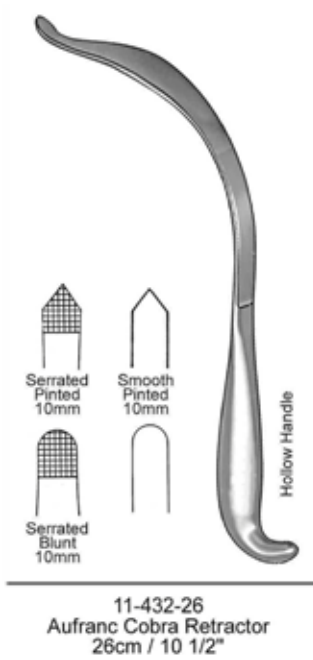
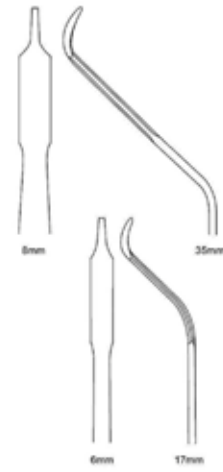
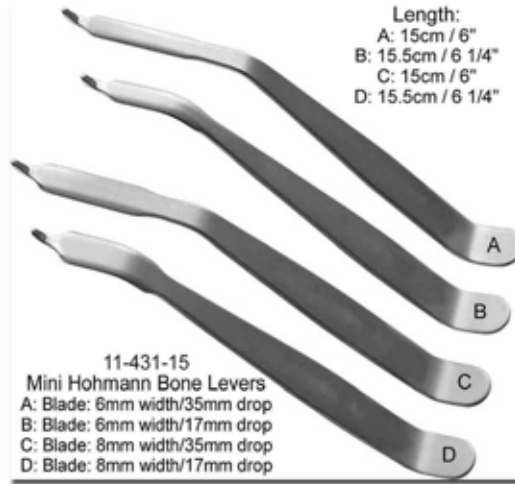
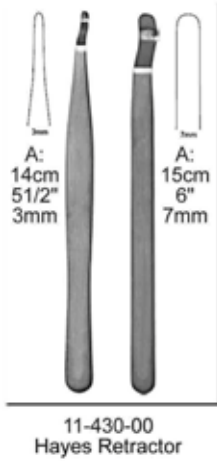

11-437-30
Ribbon Retractor Malleable
30cm / 12"



Sizes Available

- | | | |
|------------------|--------------|---------------|
| A: 6" X 6mm | F: 8" X 6mm | K: 13" X 19mm |
| B: 6" X 12mm | G: 8" X 10mm | L: 13" X 30mm |
| C: 6" X 16mm | H: 8" X 12mm | M: 13" X 38mm |
| D: 6" X 19mm | I: 8" X 16mm | N: 13" X 45mm |
| E: 7 1/2" X 25mm | J: 8" X 19mm | O: 13" X 50mm |
| | | P: 13" X 65mm |
| | | Q: 13" X 75mm |

Bone Levers-Retractors

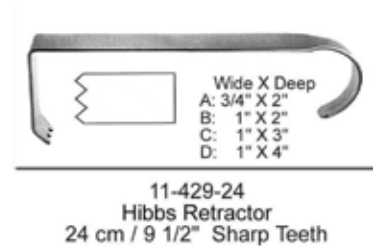
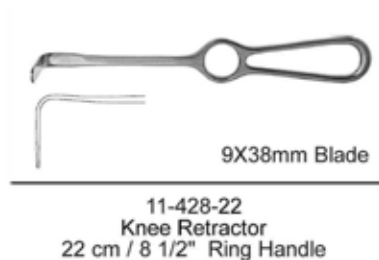
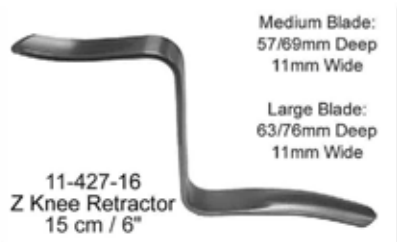
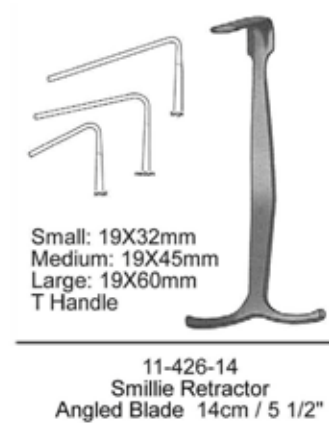
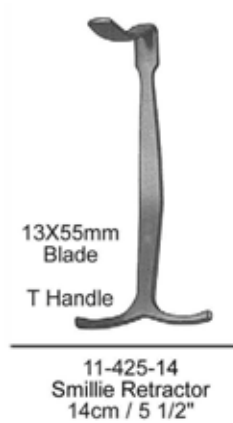
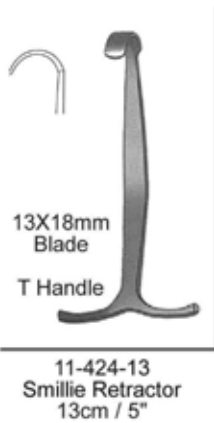
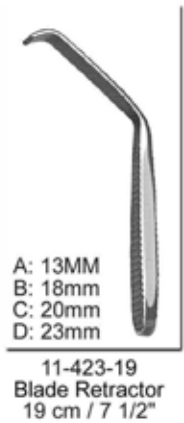
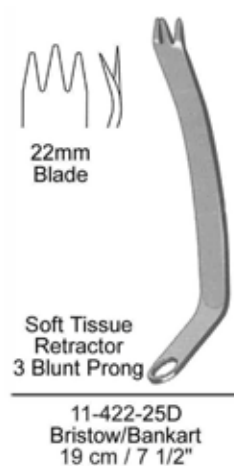
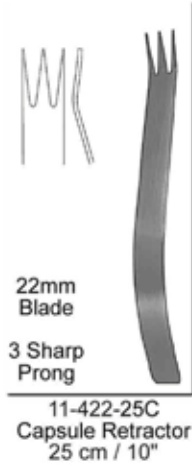
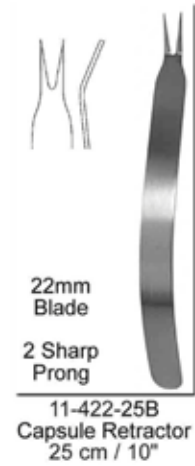
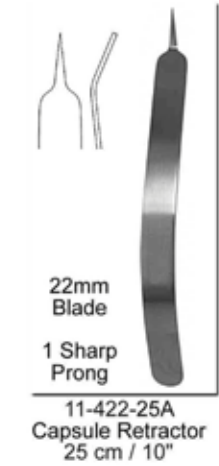
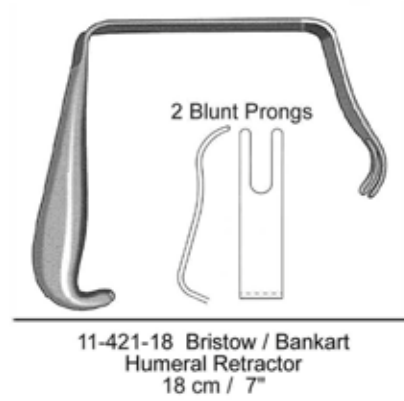
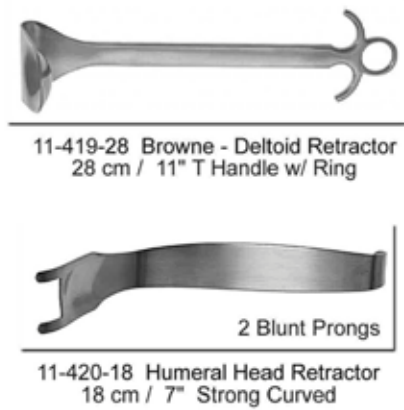
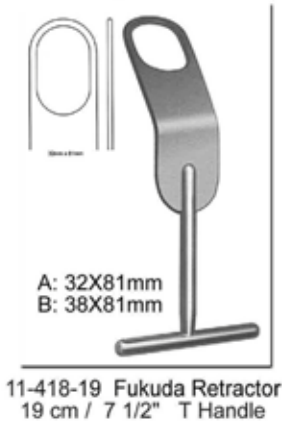

Bone Levers-Retractors



11-398-16 Bone Lever
16 cm / 6 1/4"



11-400-16 Hohman, Mini Bone Lever
16 cm / 6 1/4" 14 mm tip



11-402-22 Hohmann Bone Lever
22 cm / 8 3/4" 8 mm Tip narrow tip



11-404-23 Hohmann Bone Lever
23.5 cm / 9 1/4" 43 mm Tip narrow tip



11-408-25 Lange-Hohmann Bone Lever
25 cm / 9 3/4" 22mm Tip wide tip with groove



11-409-27 Hohmann Bone Lever 27.5 cm / 10 3/4" 24mm Tip wide, round tip

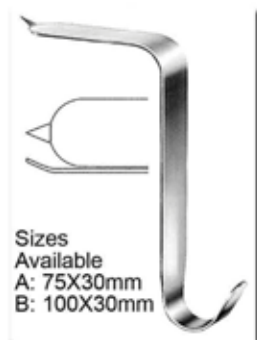

Sizes Available
A: 75X30mm
B: 100X30mm

11-415-16 A / B Taylor Spinal Retractor
16 cm/6 1/4" pointed end



11-399-16 Hohman, Mini Bone Lever 16 cm / 6 1/4" 6mm tip



11-401-16 Hohman, Mini Bone Lever 16 cm / 6 1/4" 8 mm tip



11-403-12 Hohman, Mini Bone Lever 12 cm / 4 3/4" 14 mm tip



11-406-13 Hohmann Bone Lever
13cm/5" A:3mm B:5mm C:7mm



11-405-23 Hohmann Bone Lever
23.5 cm / 9 1/4" 18 mm Tip narrow tip



11-407-29 Hohmann Bone Lever 29 cm / 11 1/2" 35mm Tip wide tip



11-411-24 A / B Bennett Bone Lever
24 cm / 9 1/2"



11-410-25 Hohmann Bone Lever 25 cm / 9 3/4" 70 mm Tip narrow tip



11-413-23 Hohmann Bone Lever
23.5 cm / 9 1/4" 43mm Tip narrow tip



11-416-25 Hohmann Bone Lever 25.5 cm / 10" 22mm Tip wide tip



11-412-26 Blount Knee Retractor
26.5 cm / 10 1/2" blunt



11-414-26 Blount Knee Retractor
26.5 cm / 10 1/2"



11-417-17 Blount Knee Retractor
17.5 cm / 7"

Bone Rasps-Files

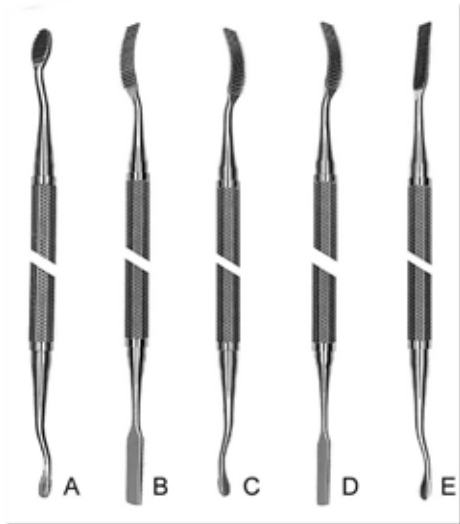

11-386-18 A/B/C/D/E
Miller-Colburn Bone File 18 cm / 7" Downwards Cut

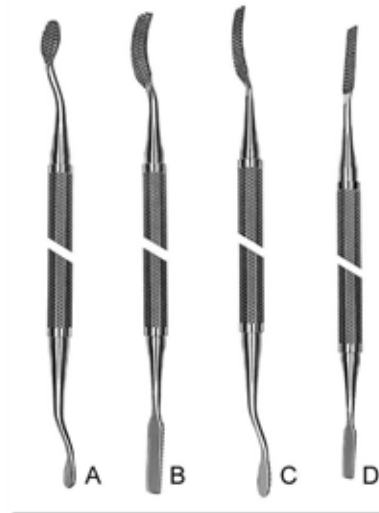

11-387-18 A/B/C/D/
Miller-Colburn Bone File 18 cm / 7" Cross Cut

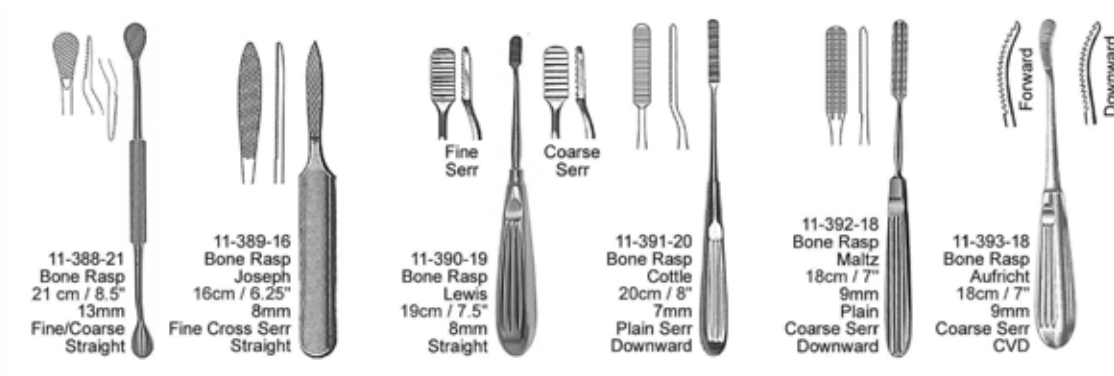

11-388-21
Bone Rasp
21 cm / 8.5"
13mm
Fine/Coarse
Straight

11-389-16
Bone Rasp
Joseph
16cm / 6.25"
8mm
Fine Cross Serr
Straight

11-390-19
Bone Rasp
Lewis
19cm / 7.5"
8mm
Straight

11-391-20
Bone Rasp
Cottle
20cm / 8"
7mm
Plain Serr
Downward

11-392-18
Bone Rasp
Maltz
18cm / 7"
9mm
Plain
Coarse Serr
Downward

11-393-18
Bone Rasp
Aufricht
18cm / 7"
9mm
Coarse Serr
CVD



11-394-21
Bone Rasp
Fomon
21 cm / 8.5"
8mmX40mm
Coarse Serr
4 Sided
Flat / Covex Baldes



11-395-21
Bone Rasp
Fomon
21 cm / 8.5"
8mmX40mm
Fine Serr
4 Sided
Flat / Covex Blades



11-396-21
Bone Rasp
Kleinert Kurtz
21 cm / 8.5"
8mmX45mm
Fine/Coarse Serr
4 Sided
Flat / Covex Blades

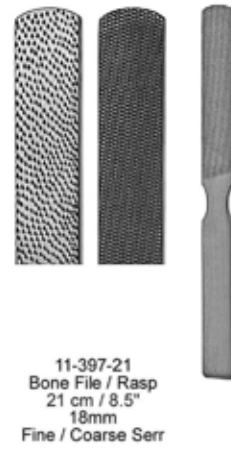

11-397-21
Bone File / Rasp
21 cm / 8.5"
18mm
Fine / Coarse Serr

Bone Rasps-Files



11-377-30 Putti Bone Rasp Round / Semi Round
30cm / 11 3/4"



11-378-27 Putti Bone Rasp Curved / Straight
27cm / 10 3/4"



11-379-28 Bone File 28 cm / 11" w/ Hollow Handle
Semi Round



11-380-24 Bone File 24.5 cm / 9 3/4"
w/ Hollow Handle Semi Round



11-382-22A Bone File 22 cm / 8 3/4"
Flat / Round



11-382-22B Bone Rasp 22 cm / 8 3/4"
Flat / Round



A: Straight
B: Curved Forward
C: Curved Backward



11-383-18A Bone File 18 cm / 7"
Fibre Handle / Cross-Hatch



11-383-18B Bone File 18 cm / 7"
Fibre Handle / Linear



11-385-18A Bone File 18 cm / 7"
Fibre Handle / STR Diamond Coated



11-385-18B Bone File 18 cm / 7"
Fibre Handle / CVD Diamond Coated



Bone Tampers-Impactors-Packers

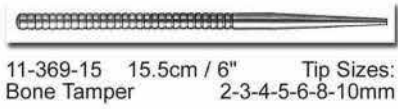

11-369-15 15.5cm / 6" Tip Sizes:
Bone Tamper 2-3-4-5-6-8-10mm



A: 2mm
B: 3mm
C: 4mm
D: 5mm
F: 6mm
G: 8mm
H: 9mm
I: 10mm

Knurling Handle

11-370-16
Bone Tamper
16cm / 6 1/4"

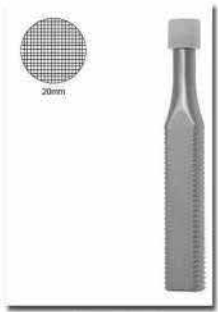

11-371-17
Bone Impactor / Teflon Tip
17cm / 6 1/2"



11-372-20
Caspar Bone Tamper
20cm / 8"

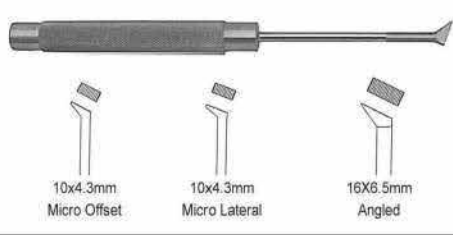

11-373-21 Lumbar / Cervical Impactor 21cm / 8 1/2"

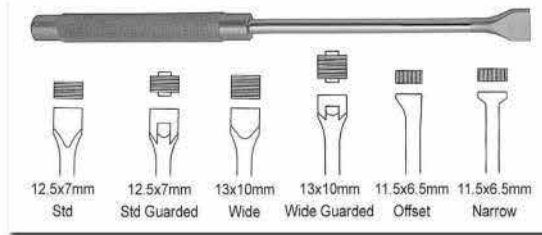

11-374-21 Lumbar / Cervical Impactor 21cm / 8 1/2"

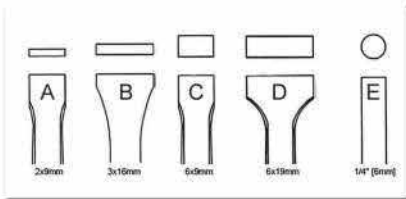

A: 2.X9mm B: 3X16mm
C: 6X9mm D: 6X19mm
E: 6mm Dia

11-375-25
Bone Chip Packer
25cm / 10"



11-376-43
Bone Tamper
43cm / 17"



9.5mm DIA



Ring Cutters-Lead Hands -Biopsy Tools



11-356-00
Martin-Ideal
Finger Nail Drill



11-357-10 Feldheim Tourniquet
10cm / 4"



11-361-16
Walton
Finger Ring Saw
16 cm / 6 1/4"



11-362-17
Finger Ring Saw
17 cm / 6 3/4"



11-358-14
Radolf
Nail Extracting Forceps

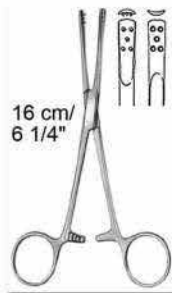

11-359-16
Nail Extracting
Forceps



11-360-18
Martin Finger
Ring Saw 18.5 cm / 6 3/4"
Spare Blades are Available
Separately



11-363-00
Finger Ring Saw
Cutter Spare



11-364-00 Lead Hand for Kids / Adults



11-365-00 Lead Hand for Kids / Adults



11-366-22
Champy-OSU Bone Biopsy Instruments
Consisting of trocar, a toothed trephine
and a plunger for taking tibial and
iliac bone grafts through a closed technique
22 cm / 8 3/4"

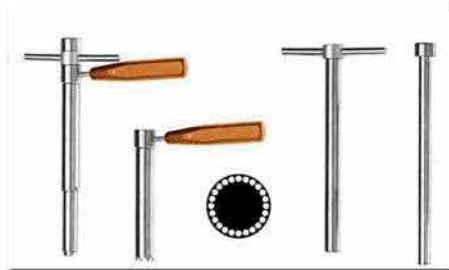

11-367-22
Champy Cancellous Bonegraft Mill
Outer Dia: 17mm
Inner Dia: 16mm

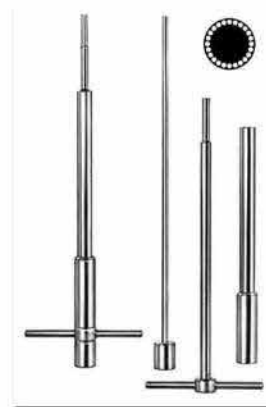

11-368-22
Champy Bone Biopsy Instruments
A: Outer Dia: 5mm Inner Dia: 4mm
B: Outer Dia: 8mm Inner Dia: 7mm
22 cm / 8 3/4"

Wire Instruments - Extension Bows ETC



11-339-21
Loute Wire Tightener 21 cm / 8 1/4"



11-340-11
Wire Tightener
w/ T Handle
11 1/2 cm / 4 1/2"



11-341-12
Wire Tightener 12 cm / 4 3/4"

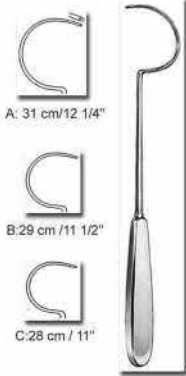

11-342-00
Demel Wire Guide



11-343-18
Bankert Ligature Carrier



11-344-00
Suture Passer



11-345-00
Suture Passer



11-346-20
Deschamps Ligature Carrier

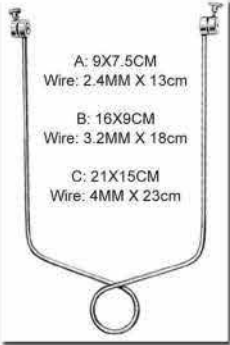

11-347-00
Böhler Extension
Bow for femur & knee

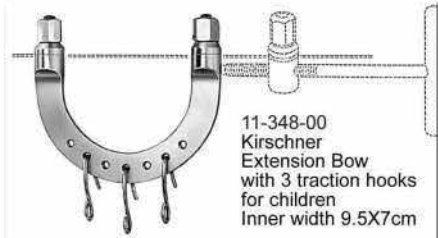

11-348-00
Kirschner
Extension Bow
with 3 traction hooks
for children
Inner width 9.5X7cm

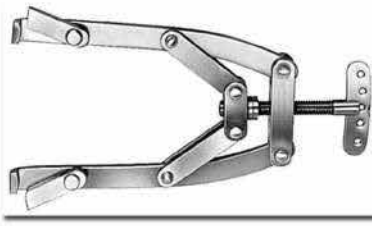

11-349-00 (Kirschner) Extension Bow
A: Small: 18.5 cm / 7 1/4"
B: Large: 26.5 cm / 10 1/2"
with 3 traction hooks



11-350-18
Wire Strainer 18.5 cm / 7 1/4"



11-351-00
Extension Bow
A: 10 1/2" X 6 1/4"
B: 7" X 4"



11-352-00
Fixation Discs
for wire drills, pair

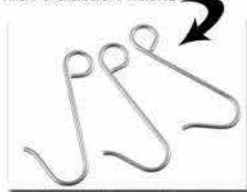

11-353-00 Traction Hook
for Extension Bows

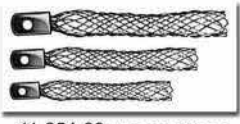

11-354-00 Extension Sleeve
Small / Medium / Large

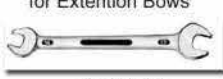





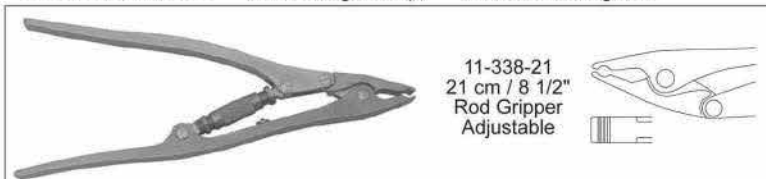
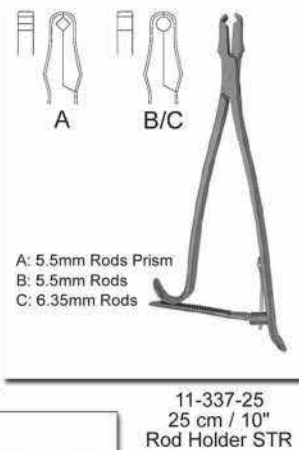
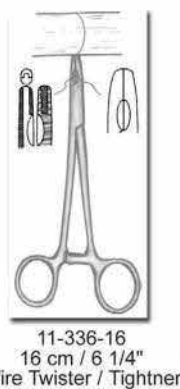
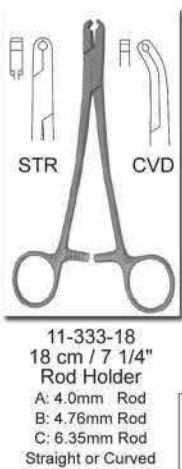
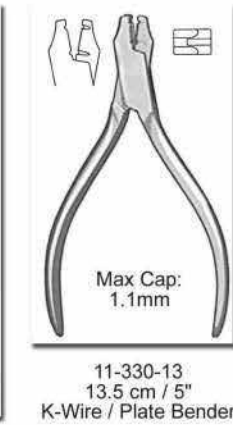
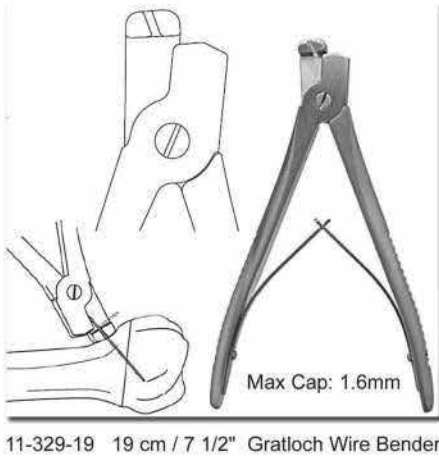
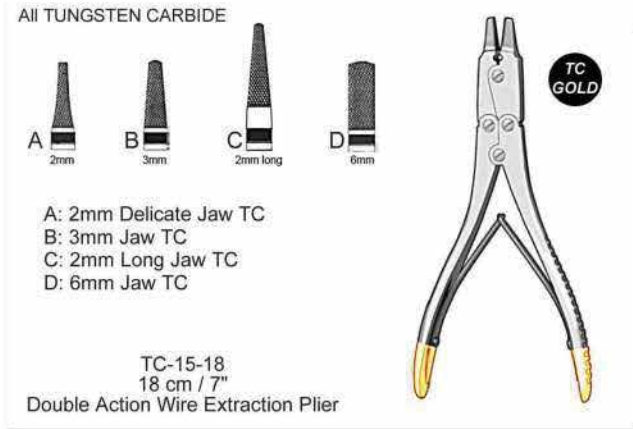
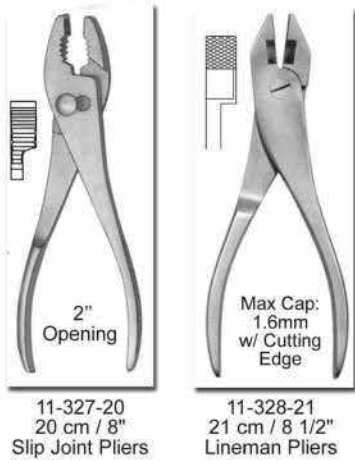

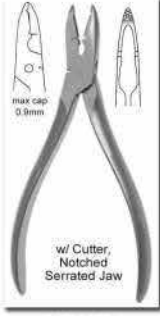
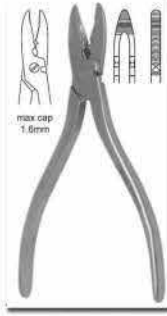
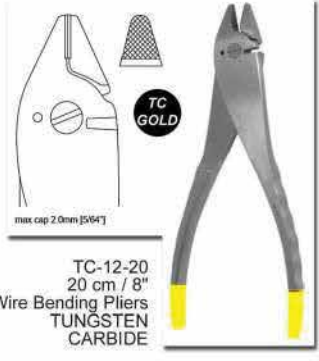

11-355-20
Wrench 20cm / 8"

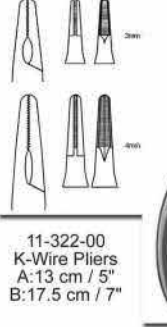
Pliers-Benders-Rod Instruments

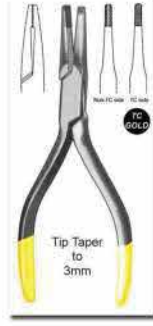

Nose Pliers-Wire cutters

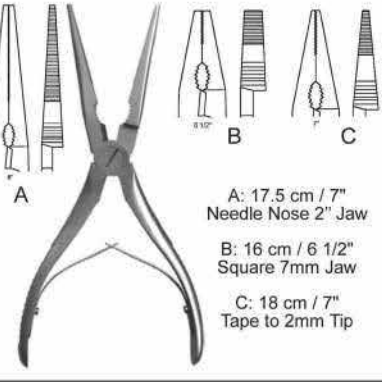
 <p>Delicate w/ Grooves Taper to 2mm For Cerclage Wire</p>	 <p>max cap 0.9mm</p> <p>w/ Cutter, Notched Serrated Jaw</p>	 <p>max cap 1.6mm</p>	 <p>max cap 2.0mm [5647]</p> <p>TC GOLD</p> <p>TC-12-20 20 cm / 8" Wire Bending Pliers TUNGSTEN CARBIDE</p>	
<p>11-317-14 14 cm / 5 1/2" Circlage Pliers / Cutter</p>	<p>11-318-20 20 cm / 8" Wire Bending Pliers</p>	<p>11-319-15 15 cm / 6" Wire Bending Pliers</p>		
 <p>Serrated Jaw 2mm Tip</p>	 <p>Serrated Jaw 5mm Tip</p>	 <p>11-322-00 K-Wire Pliers A: 13 cm / 5" B: 17.5 cm / 7"</p>	 <p>TC GOLD</p> <p>w/ Speedlock TUNGSTEN CARBIDE for 3.0 / 4.5 Screws / Pins</p> <p>TC-13-19 19 cm / 7 1/2" Screw/Pin Removing Pliers</p>	
<p>11-320-15 15 cm / 6" Needle Nose Pliers</p>	<p>11-321-14 14 cm / 5 1/2" Flat Nose Pliers</p>			
 <p>Tip Taper to 3mm</p> <p>TC GOLD</p>	 <p>Tip Taper to 3.5mm</p>	 <p>Tip Taper to 3.5mm</p>	 <p>Tip Taper to 2mm</p>	 <p>A: 17.5 cm / 7" Needle Nose 2" Jaw</p> <p>B: 16 cm / 6 1/2" Square 7mm Jaw</p> <p>C: 18 cm / 7" Tape to 2mm Tip</p>
<p>TC-14-14 14 cm / 5 1/2" Pin Puller Grips Small Pins</p>	<p>11-323-16 16 cm / 6 1/2" Flat Nose Pliers w/ Cutter for Cerclage Wire</p>	<p>11-324-19 19 cm / 7 1/2" Narrow Nose Pliers Heavy Jaws for Pulling Wire / Pins</p>	<p>11-325-17 17.5 cm / 7" Long Jaw Pliers 2inch Long Jaw Delicate</p>	<p>11-326-00 UNIVERSAL Pliers Serrated w/ Heavyduty Spring and Cutting Edge Max Cutting Cap: 1.1mm</p>

Nose Pliers. Pulling Forceps. Wire Cutters



11-300-15
Combi-Flat Nose Pliers 15 cm / 6"
for Bending & Cutting

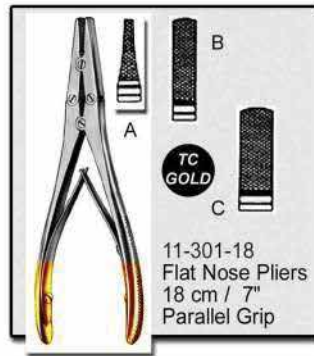

11-301-18
Flat Nose Pliers
18 cm / 7"
Parallel Grip



11-302-13 Flat Nose Pliers
13.5 cm / 5 1/4"



11-303-18 Round / Flat Nose Pliers
18 cm / 7"

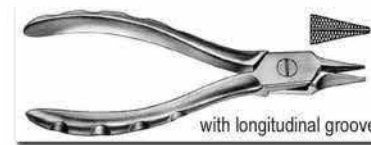

11-304-16 Hackstock Flat
Nose Pliers 16cm / 6 1/4"



11-305-17 Flat Nose Pliers
17 cm / 6 3/4" with crosswise groove



11-306-17
Flat Nose Pliers 17.5 cm / 7"



11-307-19
Flat Nose Pliers Pointed 19.5 cm / 7 3/4"



11-308-15
Platypus Nail
Pulling Forceps
15.5 cm / 6 1/4"

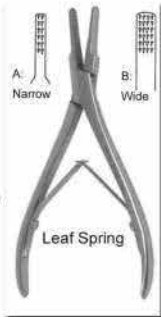

11-309-15
Platypus Nail
Pulling Forceps
15.5 cm / 6 1/4"



11-310-15
Round Nose Pliers
15.5 cm / 6 1/4"



11-311-15
Needle Nose Pliers
15.5 cm / 6 1/4"

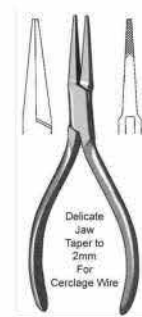

11-312-15
Flat Nose Pliers
15 cm / 6"

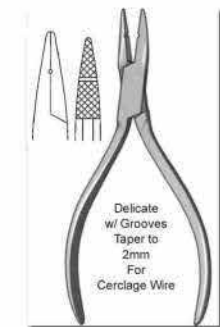

11-313-13
Needle Nose Pliers
13.5 cm / 5 1/4"

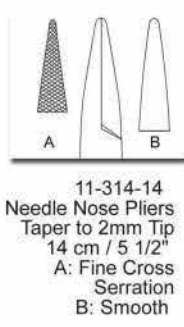

11-314-14
Needle Nose Pliers
Taper to 2mm Tip
14 cm / 5 1/2"
A: Fine Cross
Serration
B: Smooth



11-315-18
18.5 cm / 7 1/4"
Wire Cutting Pliers
Soft wires up to 2.4mm Ø
Hard wires up to 1.8mm Ø



11-316-16
Martin "Diamant"
16 cm / 6 1/4"

Soft wires up to 2.2mm Ø
Hard wires up to 1.5mm Ø

Vise Grips. Nose Pliers. Slap Hammer



11-291-18 Flat Nose Plier
18.5 cm / 7 1/4" Parallel Grip SS



11-292-18 Flat Nose Plier / Cutter
18.5 cm / 7 1/4" Parallel Grip



11-293-22 Long Nose Plier 22 cm / 8 1/4"



11-294-20
Vise Grip 20.5 cm / 8"
Stainless Steel

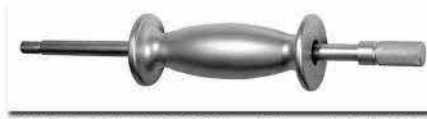

11-297-00 SLAP HAMMER w/ Threaded Shaft Head
to be used with 11-298-00 and 11-299-00



11-297-01 SLAP HAMMER w/ Hexa Shaft Head
to be used with 11-298-00 and 11-299-00



11-298-00 Regular Jaw Locking Plier
A: 18 cm / 7" B: 20 cm / 8"
C: 23 cm / 9"



11-295-23
Vise Grip 23 cm / 9"
Locking Plier



11-295-20
Vise Grip 20.5 cm / 8"
Locking Plier



11-295-18
Vise Grip 18 cm / 7"
Locking Plier



11-296-30
Needle Nose Locking Plier
30 cm / 12"



11-296-25
Needle Nose Locking Plier
25.5 cm / 10"



11-296-22
Needle Nose
Locking Plier
22 cm / 8.5"



11-299-00
Needle Nose Locking Plier
A: 22 cm / 8.5"
B: 25.5 cm / 10"
C: 30 cm / 12"

Bone Holding Clamps.Traction Bar



11-286-00
Standard

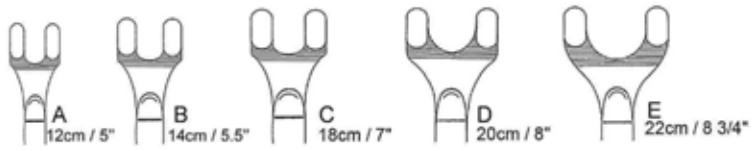

Gerster-Lowman Bone Holding Clamp



11-290-15
Gerster Traction Bar
15cm / 6"

11-287-00
Angled

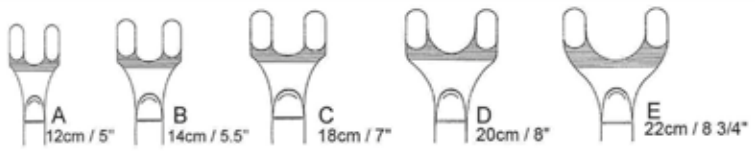

Gerster-Lowman Bone Holding Clamp

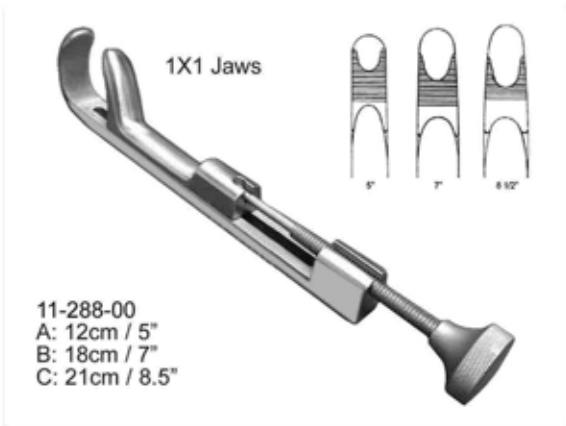

Gerster-Lowman Bone Holding Clamp



Gerster-Lowman Bone Holding Clamp

Orthopedic Drills Bitts.Burrs.Trephines



11-271-00 5mm Borchardt Shaft Twist Drill
Long Working End
A: 2.0mm B: 2.5mm C: 3.0mm D: 3.2mm E: 3.5mm F: 4.0mm G: 5.0mm H: 6.0mm I: 7.0mm



11-272-00 5mm Borchardt Shaft Twist Drill
A: 1.0mm B: 1.5mm C: 1.8mm D: 2.0mm E: 2.2mm F: 2.5mm G: 2.8mm H: 3.0mm I: 3.2mm J: 3.5mm K: 4.0mm L: 5.0mm



11-273-00 5mm Borchardt Shaft Flat Trphine
A: 1.8mm B: 2.0mm C: 2.2mm D: 2.5mm E: 3.0mm F: 3.5mm G: 4.0mm H: 5.0mm



11-274-00 5mm Borchardt Shaft Spherical Burr
A: 3.0mm B: 4.0mm



11-275-00 5mm Borchardt Shaft Spherical Burr
A: 3.0mm B: 5.0mm



Long 5mm Borchardt Shaft
11-276-00 Doyen Spherical Burr
A:4mm B:6mm C:8mm D:10mm E:12mm F:14mm G:16mm



Short 5mm Borchardt Shaft
11-277-00 Doyen Spherical Burr
A:4mm B:6mm C:8mm D:10mm E:12mm F:14mm G:16mm



11-278-00 Doyen Conical Burr
Coarse Spacing 12mm Dia



11-279-00 Doyen Conical Burr
Fine Spacing A:8mm / B:10mm



11-280-00 Doyen Cylindrical Burr
Coarse Spacing A:12mm / B:15mm



11-281-00 Albee Burr Oval
Coarse Spacing A:8mm / B:10mm / C:12mm



11-282-00 Albee Burr Pointed
7mm



11-283-00 Borchardt Burr Oval
Coarse Spacing 13mm



11-284-00 Flat Burr
Short Borchardt Shaft 25mm



11-285-00 Toti Trephine
Short Borchardt Shaft 8mm

Orthopedic Hand Bone Drills .ACC



11-261-00
Hand Drill
All Covered
Polished / Dull or Coated.
Drills Holder at Bottom.



11-262-00
Hand Drill
All Covered
Light Weight
Polished / Dull or Coated.
Key Holder and Self Retaining Locking Mechanism



11-262-01
Box for Hand Drills W/ Art #s: 11-261-00 and 11-262-00 Outside Artificial Leather / Inside Jumbo Foam



11-263-00
Hand Drill
Polished / Dull or Coated.
Operated Horizontally and Vertically

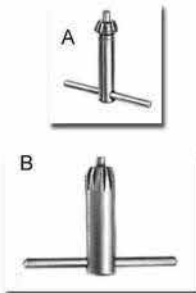

All Hand Drills Provided with Keys



11-264-00
Hand Drill
Polished / Dull or Coated.
All Covered



11-265-00
Hand Drill
Polished / Dull or Coated.
Open Housing



11-266-01
Hand Drill
Polished / Dull or Coated.
Open Housing



11-267-00
Hand Drill
Polished / Dull or Coated.
Semi Closed Housing



11-268-14 Vickers Easidriver 14 cm / 5 1/2"



11-269-14 14cm / 5 1/2"
Handle W/ Chuck Longitudinally Bored Accomodating up to 3,95mm



11-270-02
Key



11-270-00
Handle with chuck T-Shaped



11-270-01
Key



11-270-03
Fibre T-Handle Key

Orthopedic Hand Bone Drills .ACC

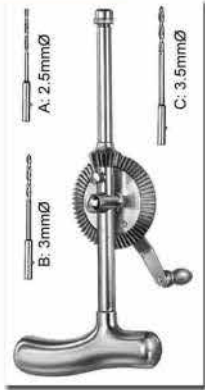

11-253-24
Stille-Sherman Hand Drill
24 cm / 9 1/2"
with 3 twist drills



11-254-20
Stille Hand Drill
20.5 cm / 8"
w/ 9 Twist Drills

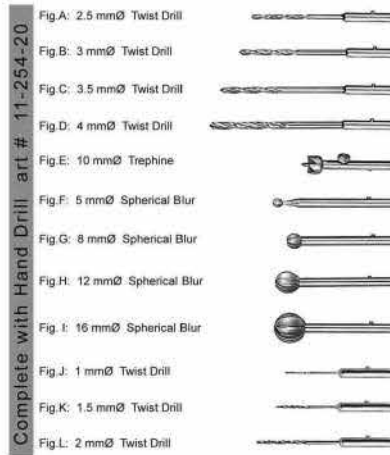

11-254-01

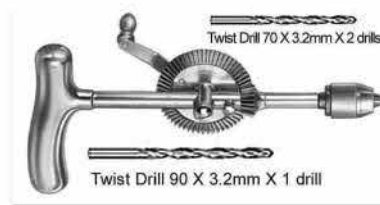
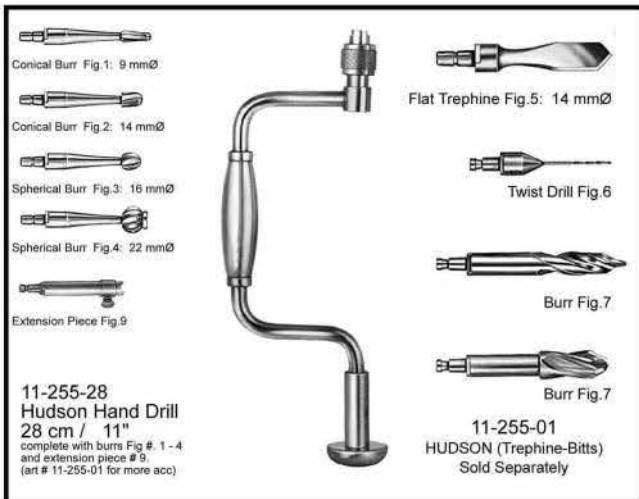

11-256-00 Moore Hand Drill
complete with a set of 3 twist drills

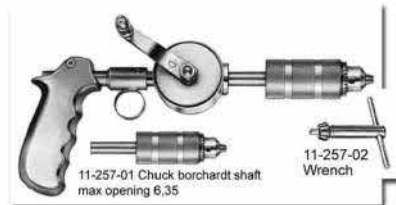

11-257-00
Martin Hand Drill with Chuck & Wrench



11-258-16
Bunnell Hand Drill
16cm / 6 1/4"

Longitudinally Bored with 3-Jaw-Chuck
Light Metal Housing
opening up to 4mmØ

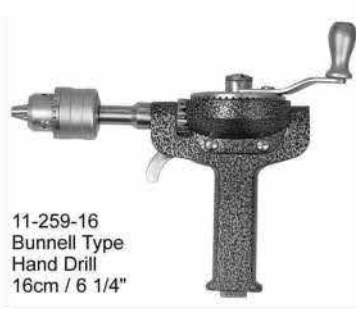

11-259-16
Bunnell Type
Hand Drill
16cm / 6 1/4"

Twin Shade Powder Coated
Longitudinally bored with 3-Jaw-Chuck
light metal housing opening up to 4mmØ



11-260-00
Ralk Hand Drill

Light Metal Housing
Literally Angled Handle with 3-Jaw-Chuck
and key, opening up to 6,35mmØ

Remaers .Awis . Bone Hooks



11-239-13
Reamer
13.5 cm / 5 1/4"



11-240-18
Perthes Reamer
18 cm / 7"



11-241-21
Perthes Reamer
21.5 cm / 8 1/2"



11-242-14
Reamer
One concave side
14 cm / 5 1/2"



11-243-20
Glenoid Punch
20cm / 8"



11-244-00
Shoulder Percussion Awl
A:21.5cm / 8 1/2" B: 23.5cm / 9 1/4"



11-245-00
Shoulder Penetrating Awl
Fibre Handle
A: 18cm / 7" B: 23cm / 9"



11-246-28
Kuntscher Diamond Awl 28cm / 11"

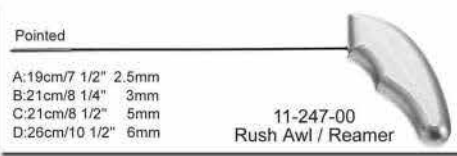

Pointed
A:19cm/7 1/2" 2.5mm
B:21cm/8 1/4" 3mm
C:21cm/8 1/2" 5mm
D:26cm/10 1/2" 6mm
11-247-00
Rush Awl / Reamer

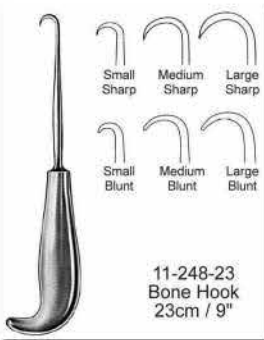

Small Sharp Medium Sharp Large Sharp

Small Blunt Medium Blunt Large Blunt

11-248-23
Bone Hook
23cm / 9"

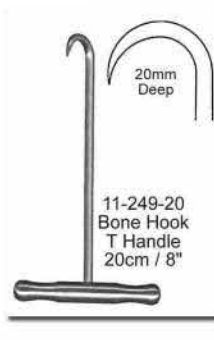

11-249-20
Bone Hook
T Handle
20cm / 8"



11-250-14
Bone Hook T Fibre Handle
14cm / 5 5/8"



11-251-00 Volkman Bone Hook
A: 20cm / 8" 19X27mm Sharp
B: 23cm / 9" 15X20mm Blunt
C: 23cm / 9" 15X20mm Sharp
C: 25cm / 9 3/4" 15X20mm Sharp



11-252-25
Pointed Awl
Fibre Handle
25cm / 10"

Amputation Saw . Gigli Saw



11-230-35 Charrière Amputation Saw
35 cm / 13 3/4"

- A Spare Saw Blades
21.5 cm / 8 3/4" 12mm wide
- B Spare Saw Blades
21.5 cm / 8 3/4" 15mm wide
- C Spare Saw Blades
21.5 cm / 8 3/4" 18mm wide

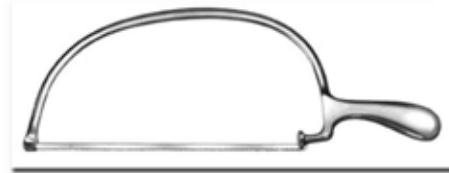

11-231-40 BIER Amputation Saw
40.5 cm / 16"

- A Spare Saw Blades
27 cm / 10 3/4" 4mm wide
- B Spare Saw Blades
27 cm / 10 3/4" 6mm wide
- C Spare Saw Blades
27 cm / 10 3/4" 8mm wide



11-232-24 Langenbeck Amputation Saw
24.5 cm / 9 3/4"



11-233-29 Satterlee Amputation Saw 29 cm / 11 1/2"
Also: Spare Saw Blade Available in 20 cm / 8 1/4" Size



11-234-27 Charrière Amputation Saw 27 cm / 10 1/2"



11-235-23 Satterlee Amputation Saw 23 cm / 9"

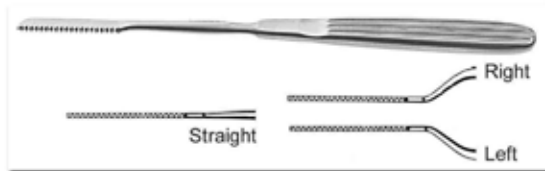

11-236-27 Joseph Amputation Saw 18 cm / 7"



11-237-27 Percy Amputation Shield 30 cm / 12"

- 11-238-00 serrated blade
- A: Gigli Saw 30cm
- B: Gigli Saw 50cm
- C: Tyler Gigli Saw (Large Cut) 30cm
- D: Tyler Gigli Saw (Large Cut) 30cm



11-238-01 Gigli
Sold in Pair

11-238-02 Struly Gigli
Sold in Pair

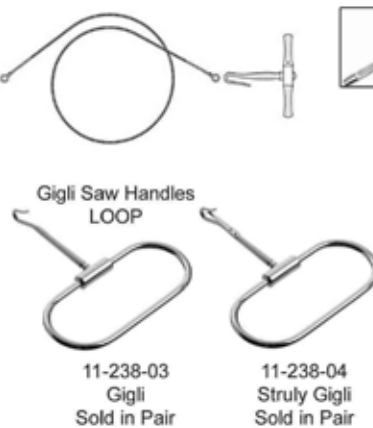

11-238-03
Gigli
Sold in Pair

11-238-04
Struly Gigli
Sold in Pair



11-238-05
BAILEY Gigli Saw Guide 30cm



11-238-06
POPPE Gigli Saw Guide 28cm

Orthopedic Dressing - Plaster Instruments

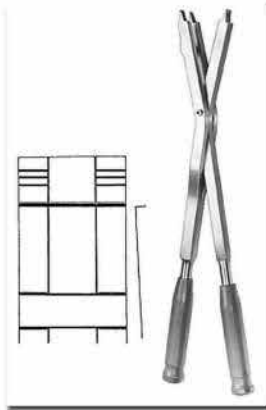

10-214-48
Hermann Plaster Spreader
48 cm / 19" Heavy Pattern



10-215-28
Hennig Plaster Spreader
28 cm / 11"

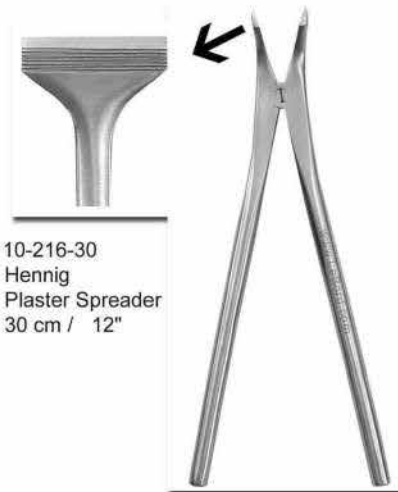

10-216-30
Hennig
Plaster Spreader
30 cm / 12"



10-217-30
Beeson Plaster Spreader
1.5 In Blade
30 cm / 12"



10-218-23
Walton Plaster Spreader
w/Spring 3 Prongs
23 cm / 9"

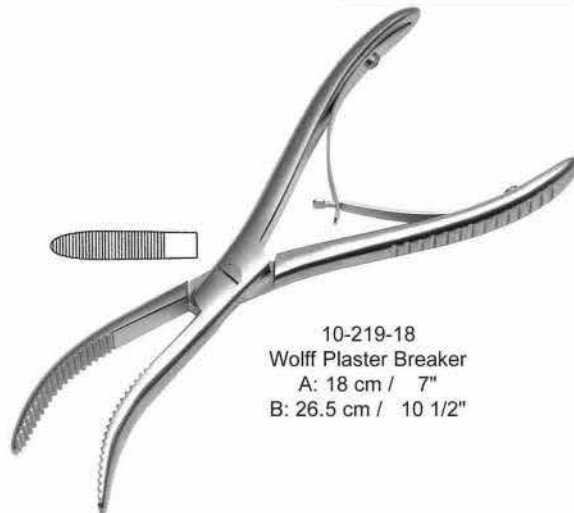

10-219-18
Wolff Plaster Breaker
A: 18 cm / 7"
B: 26.5 cm / 10 1/2"



For Non TC
10-10-18
TC-10-18
Lister
Bandage Scissors
TC / Handle gold
18 cm / 7"



TC-11-24
Bruns
Plaster Scissors
24 cm / 9 1/2"

For Non TC
10-11-24



Orthopedic Dressing - Plaster Instruments

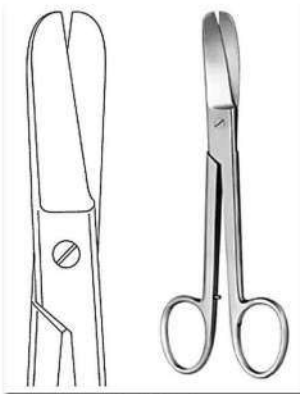

10-200-23
Lorenz Bandage Scissors
Heavy Pattern 23 cm / 9"



Also available
in 18.5 cm / 7 1/4"
& 20 cm / 8"

10-201-14
Lister Bandage Scissors
14.5 cm / 5 3/4"

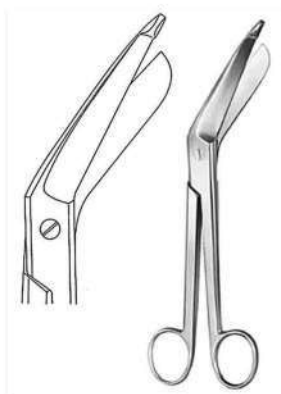

10-202-23
Bergmann Plaster Shears
Heavy Pattern
23.5 cm / 9 1/4"



10-203-20
Esmarch Plaster Shears
Heavy Pattern, Short Blades
20 cm / 8"



Also available
in 18cm / 7 1/2"

10-204-16
Bandage Scissors
16 cm / 6 1/4"
Black Plastic Rings



10-205-24
Bruns Plaster Scissors
24 cm / 9 1/2"
One Serrated Cutting Edge



Also Available
26 cm / 10"
38 cm / 15"

10-206-23
Stille-Martin
Plaster Shears
23 cm / 9"



10-207-15
Engel Plaster Saw 15.5 cm / 6"



10-208-20
Hopkins Plaster Knife
20 cm / 8"
with Wooden Handle



10-209-18
Esmarch
Plaster Knife
18 cm / 7"



10-210-18
Reiner
Plaster Knife
18 cm / 7"



10-211-21
Martin
Plaster Knife
21 cm / 8 1/4"
with wooden handle



10-212-15
Engel Plaster Saw 15.5 cm / 6"



10-213-18
Bergmann
Plaster Saw
18cm / 7"



Get in Touch With Us:

Head Office (United Kingdom):

SurgiForge Enterprises LTD
91 Donegall Avenue,
Belfast, Northern Ireland,
United Kingdom, BT12 6LS

Manufacturing Facility (Pakistan):

SurgiForge Enterprises LTD
47 Allama Iqbal Rd,
Small Industrial Estate,
Sialkot, Pakistan 51310

Phone:

+44 7878 929749
+92 315 4060304

WhatsApp:

+44 7878 929749

Email:

info@surgiforge.com

Website:

www.surgiforge.com

Follow us:

Facebook:
Surgiforge.instruments

Instagram:
@surgi_forge

Tiktok:
@surgiforge

LinkedIn:
surgiforge-instruments

If you have any questions or require assistance,
don't hesitate to reach out to our team.